

Welcome to the World of

MODEL 7-254

2-XL™

The **TALKING** Robot
With A Mind Of His Own

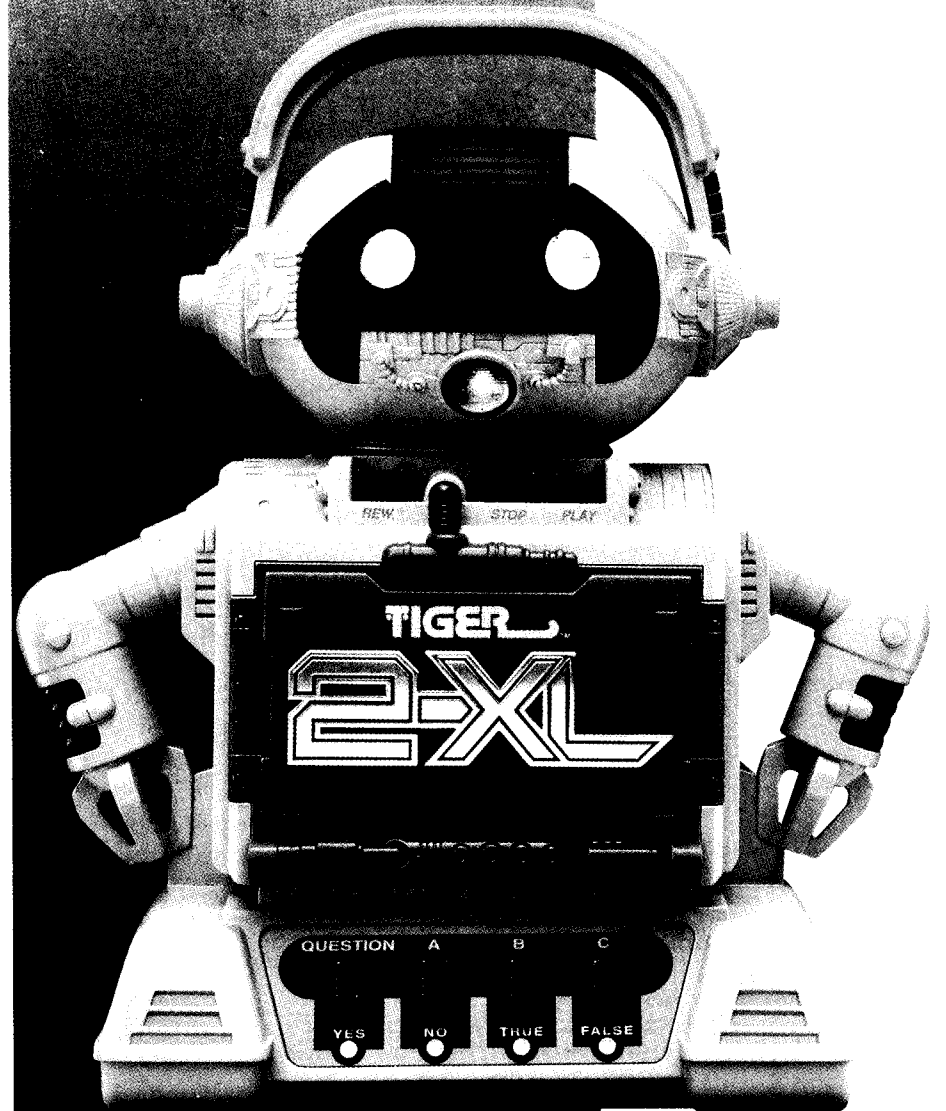

TIGER ELECTRONICS
INC.™

980 Woodlands Parkway, Vernon Hills, Illinois 60061, USA.

TM is a trademark of Tiger Electronics, Inc. © 1992 Tiger Electronics, Inc.

PRINTED IN HONG KONG

U.S. Patent Number 4,078,316

7254IW1TIE-4

INSTRUCTIONS

WELCOME TO THE WORLD OF THE FUTURE

In your future, you have a special friend named 2-XL. 2-XL can tell you stories and jokes, ask you questions and really respond to your answers! He'll introduce you to the most amazing people, places and things! With 2-XL as your wonderful new friend, the future is now!

This booklet shows you how to play with 2-XL.
KEEP THESE INSTRUCTIONS! DON'T THROW THEM AWAY!

LOOK WHO'S TALKING!!!

This is a drawing of 2-XL. It shows all his control buttons and tells you what page of the Instructions to look on to learn how to make 2-XL talk to you and how you can communicate with him!

- A. Cassette Compartment Page 5
- B. Tape Operation Buttons Page 6
- C. Volume Control Page 6
- D. 2-XL Answer Buttons Page 7,8
- E. Earphone Jack Page 9
- F. A/C Adaptor Jack Page 9

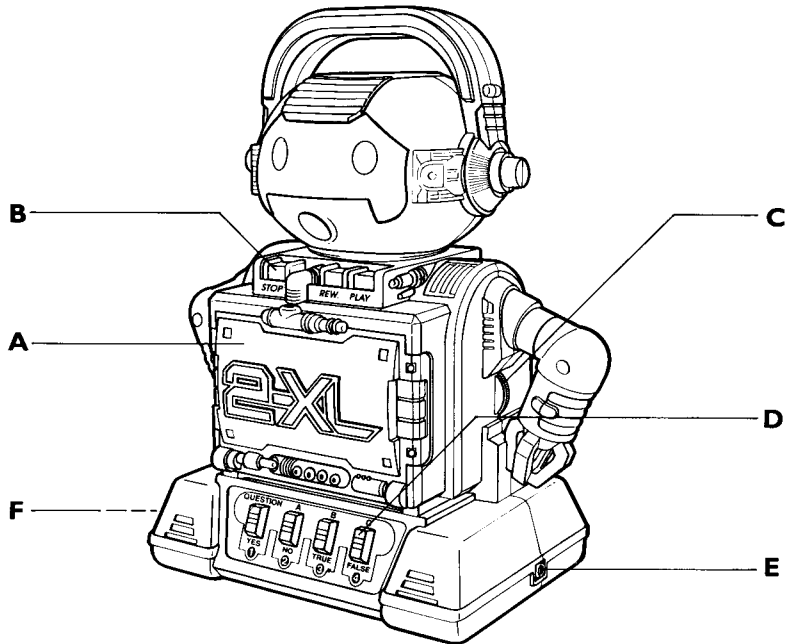

2-XL has a special place to store two extra cassette tapes when you're not using them!

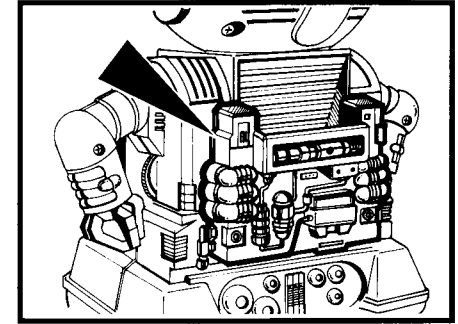

INSERTING THE BATTERIES

To bring 2-XL to life, you have to insert 4 "D" cell batteries. (Batteries not included.) Alkaline batteries are recommended. Do not use rechargeable batteries. Or, you can use 2-XL with an A/C adaptor (see page 9). To insert batteries:

1. Place 2-XL on his back. Now you can see the battery compartment on the bottom of 2-XL.
2. Put your thumbs on top of the two flaps, as you see in the picture. Push down with your thumbs and pull gently towards yourself. The battery compartment door should open. Remove the battery compartment door and put it aside.
3. Insert the four "D" cell batteries. Be sure to follow the diagram and the markings inside the compartment, so you line up "+" and "-" correctly. Replace the battery compartment door and snap it shut.

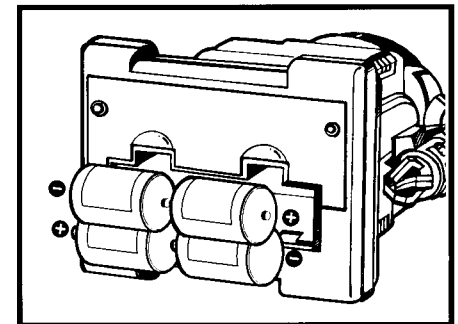
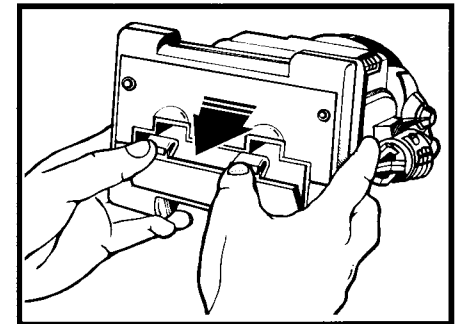

SPECIAL NOTES

1. Keep 2-XL away from water. Remember, he's a robot and not a plant! 2-XL operates electronically, so getting him wet can ruin him.
2. Clean 2-XL only with a soft DRY cloth.
3. Very high or very low temperatures can harm 2-XL. Do not leave him in direct sunlight, on or near a heat source, or outside.
4. Replace 2-XL's batteries at the first sign that he is not operating correctly. This includes lights failing to flash on and off and Tape Operation Buttons not working.
5. Never stick a pencil, pen or anything else inside 2-XL, or you may damage him.

INSERTING THE CASSETTE TAPE

Before you can begin to play with 2-XL, you must insert a 2-XL program tape into the cassette compartment.

1. Open the cassette compartment by putting your fingers on the two blue panels and pulling the compartment door open gently.

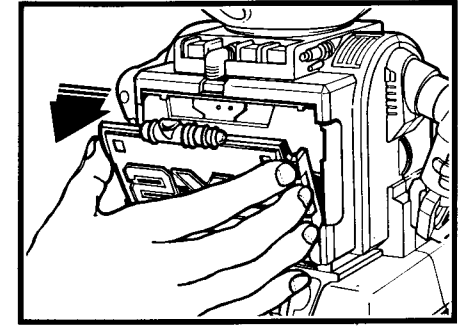

2. Insert the cassette, making sure that the label on the cassette is facing you and that you can read it. Make sure that the exposed tape is facing UP. The tape should fit exactly into 2-XL.

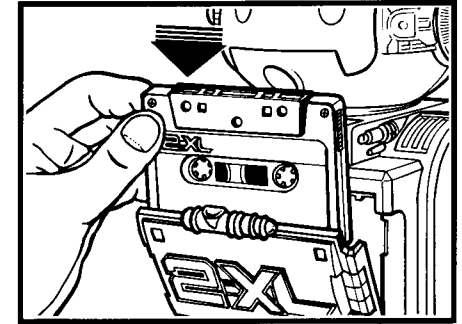

Now, gently close the cassette compartment door. Don't force it shut! If the door doesn't close all the way, it means that the cassette tape is not inserted correctly. Remove the cassette and try again. If the tape cassette door comes off, ask an adult to help you put it back on. It was made so it could be re-attached easily. NOTE: 2-XL should only be played while the cassette door is shut.

Now you're ready for fun, excitement and adventure with 2-XL!

PLAYING A 2-XL PROGRAM TAPE

Press the button marked PLAY to turn on 2-XL. In a few seconds, you'll hear 2-XL start to speak, and his eyes and mouth will flash!

When you want to STOP the program tape, press the STOP button. This will also turn off 2-XL.

If you want to hear a tape again from the beginning, press the REWIND button. When you no longer hear the rewinding motor you must press STOP. The REWIND button will not pop up by itself. Before you can play the tape again, you should press STOP and then press PLAY. 2-XL tapes should always be rewound to the very beginning, (otherwise it could mix up his brains). 2-XL will tell you when to rewind the tape. 2-XL tapes are never turned over. 2-XL tapes should never be played in anything but the 2-XL Robot.

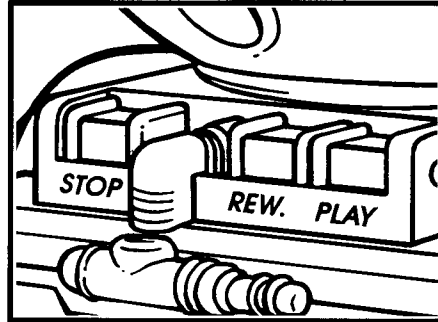

TURN UP THE VOLUME

There is a dial underneath 2-XL's arm. No, this isn't to tickle him! This dial controls the VOLUME of 2-XL's voice. Turning the dial UP makes him LOUDER. Turning the dial DOWN makes him speak more softly.

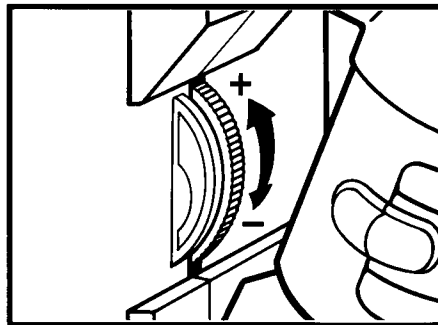

QUESTIONS AND ANSWERS WITH 2-XL

The best thing about playing with 2-XL is that he plays back! You can really communicate with him. You do this by using the four answer buttons beneath 2-XL's cassette compartment.

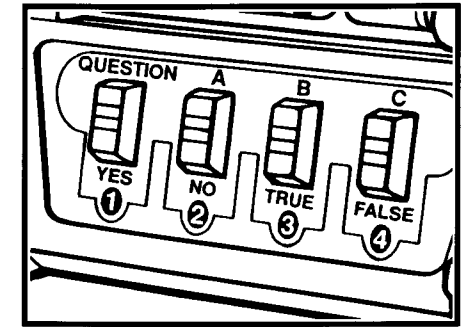

Whenever 2-XL asks you a question, don't press a button until after he says the word "NOW".

Follow 2-XL's instructions very carefully and only press those buttons he tells you to push.

Never press an answer button on your own. Press only when 2-XL tells you to.

You can press the STOP button any time during a 2-XL program. (Such as if you need more time to think about an answer. Press STOP during the computer sounds, think as long as you want, then press your answer, and then press PLAY.)

2-XL is probably the smartest robot you will ever meet. He will ask you all kinds of questions.

When 2-XL asks to you press the Question Button, press the first button on the left.

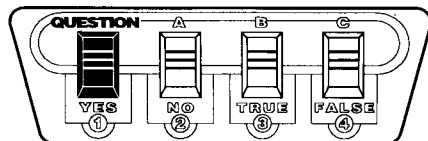

When 2-XL asks you a yes or no question, answer by pressing either yes or no only; the first two buttons.

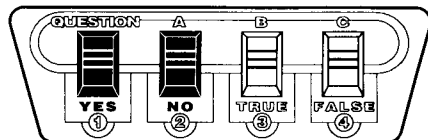

When 2-XL asks you a true or false question, answer by pressing either true or false only; the last two buttons.

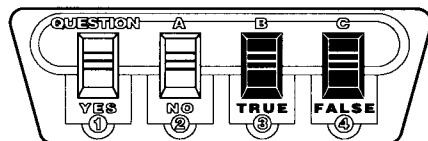

When 2-XL asks you to answer a question with A, B or C, answer by pressing buttons A, B or C only; the last three buttons.

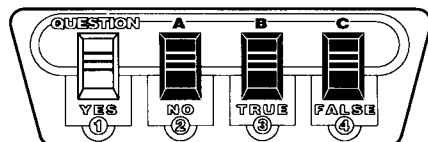

When 2-XL asks you to answer a question with number 1, 2, 3 or 4, answer by pressing buttons 1, 2, 3 or 4 only.

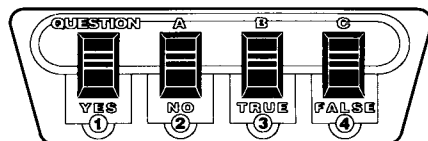

If you make a mistake by not following 2-XL's instructions carefully, his logic and memory will not operate properly.

If you want to change your answer, you can do this as much as you want while the computer sounds are heard.

Now you're ready to answer anything 2-XL can ask you! Just remember, wait until after the word "NOW" to press his buttons.

2-XL CAN PLAY OTHER CASSETTES YOU OWN

2-XL can also play standard cassette tapes you own! This includes music tapes. Use the PLAY, STOP and REWIND buttons just as you would on any cassette player. Of course, when you play your own cassettes, you won't hear 2-XL's voice -- you'll hear what is recorded on your cassette.

To play the first side of your own tape, press Question Button ①, then press PLAY. If you want to listen to the second side of your tape, you must turn the tape over when side one is done and press Question Button ① again.

A/C ADAPTOR AND EARPHONE

You can play with 2-XL using a 6 volt A/C ADAPTOR that you can buy at a store. This will let you play with 2-XL without batteries.

If you want to buy an A/C adaptor, it must be a 6 VOLT, 500-750MA OUTPUT AC TO DC ADAPTOR.

You can play with 2-XL using an EARPHONE that you can buy at the store. This will let you play with 2-XL alone, without anyone else listening to your fun.

If you want to buy an earphone, it must be an Eighth Inch (3.5mm) Mini Plug.

The drawings show you where you can plug in the A/C adaptor and Earphone.

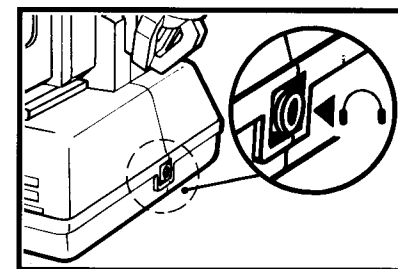
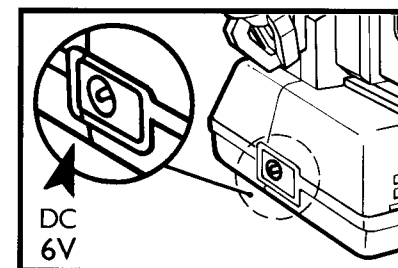

If 2-XL does not operate, check these four things:

1. That batteries are good and are inserted properly.
2. That cassette is rewound and is inserted properly.
3. That volume is turned up.
4. That an A/C adaptor is plugged into 2-XL but not into the wall outlet (since this disconnects his batteries).

If you are using an A/C adaptor to power 2-XL, be sure that it is plugged into 2-XL and into the electrical outlet. Also, be sure that the (+) and (-) are set properly.

2-XL's wit and wisdom are available in a series of specially created interactive program tapes. Some programs are designed and written to appeal to younger children, ages 4-6, while others focus on topics of interest to 7-12 year olds. Look for these and other 2-XL tapes where toys are sold.

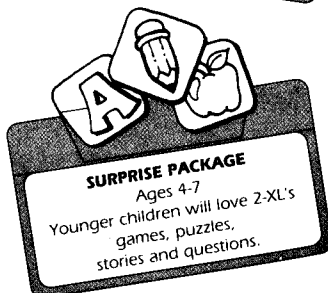
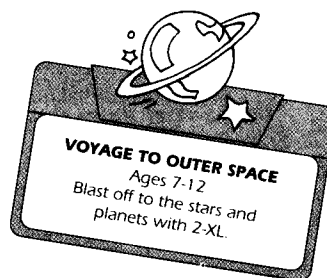
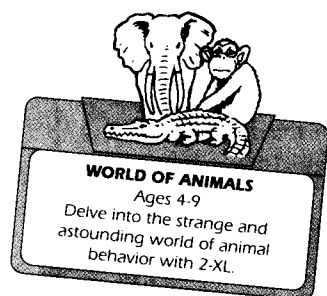
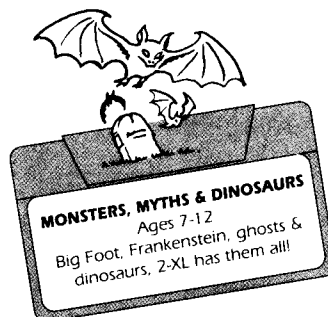
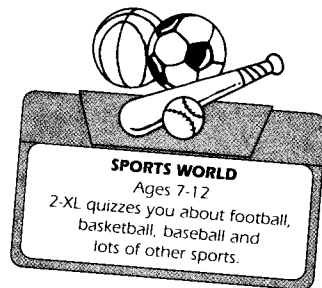
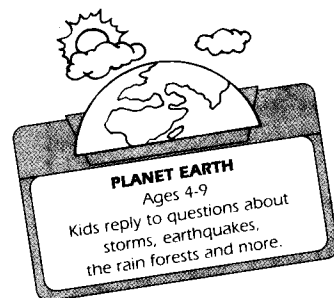
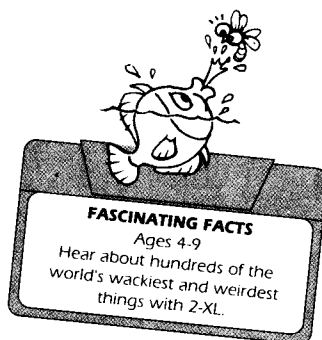
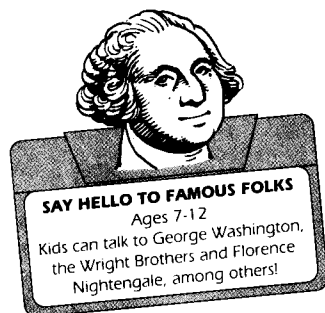
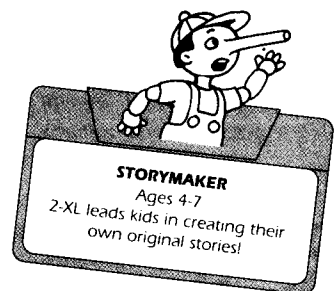

Tiger Electronics, Inc. warrants to the original consumer purchaser of its 2-XL Robot that the product will be free of defects in material or workmanship for 90 days from date of purchase.

During this 90-day warranty period the 2-XL Robot will either be repaired or it will be replaced (at our option) without charge to the purchaser, when returned either to the dealer with proof of the date of purchase, or when returned prepaid and insured with proof of date of purchase, to Tiger Electronics, Inc. 980 Woodlands Parkway, Vernon Hills, Illinois 60061, USA.

Units returned without proof of the date of purchase, or units returned after the warranty period has expired, will be repaired or replaced (at our option) for a service charge of US\$20.00. Payment must be made by check or money order. This non-warranty service will only be available for one year from the date of purchase. All non-warranty units must be returned postage paid and insured to TIGER ELECTRONICS, INC. REPAIR CENTER, 980 WOODLANDS PARKWAY, VERNON HILLS, ILLINOIS 60061, USA.

Tiger Electronics, Inc. will not be liable for loss of use of the product or other incidental or consequential costs, expenses, or damages incurred by the purchaser. Any implied warranties are limited in duration to the period from the original date of purchase.

This warranty gives you specific legal rights and you may also have other rights which vary from state to state so the foregoing limitations may not apply to you. This warranty does not cover damage resulting from accident, unreasonable use, negligence, improper service or other causes not arising out of defects in material or workmanship.

HOW TO GET SERVICE FROM THE TIGER ELECTRONICS, INC. REPAIR CENTER ON YOUR 2-XL ROBOT DURING AND AFTER THE WARRANTY PERIOD. During the warranty period, you may have a defective 2-XL replaced at the dealer from which it was purchased. If, however, during the warranty period, you choose to obtain repair or replacement from the Tiger Electronic Toys Repair Center, please make the arrangements described below:

- 1) Pack 2-XL carefully in a sturdy box with plenty of packing material all around and tape securely closed.
- 2) Carefully print on the box or carton the following name and address
TIGER ELECTRONICS, INC.
REPAIR CENTER
980 Woodlands Parkway,
Vernon Hills, Illinois 60061, USA.
Also, don't forget to show your return address.
- 3) Include a note stating what is wrong with your 2-XL.
- 4) Put parcel post stamps on the package; insure the package, then mail.

After the warranty period, do all of the above PLUS enclose your check or money order for US\$20.00 payment for the repair service.