



Ice HammerTM Vehicle

INSTRUCTIONS

BATMAN and all related elements are the property of DC Comics. TM & © 1994 All Rights Reserved.



*© Kenner, A Division of Tonka Corporation, Cincinnati, Ohio 45202

- 1** To assemble each side weapon, position as shown. Push down as indicated by the arrow.

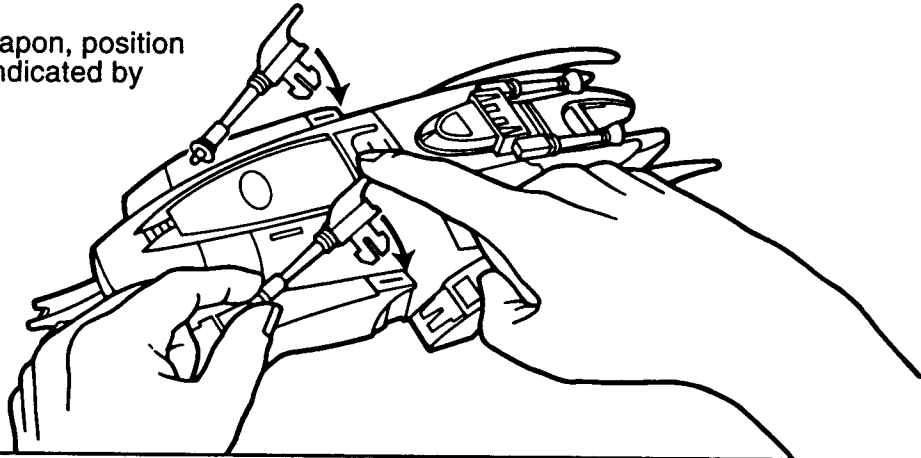

- 2** Apply labels following numbers on label sheet using this illustration as a guide.

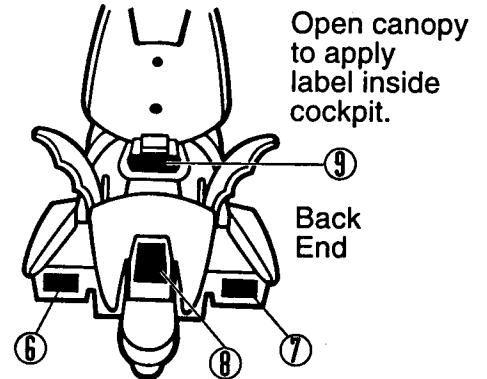
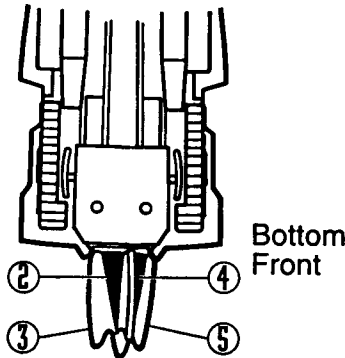
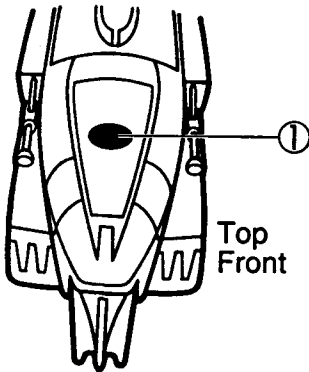

- 3** Most Batman: *The Animated Series* figures will fit into the cockpit. Raise canopy shield and insert figure in a seated position with arms down. When inside, tilt figure back into place.

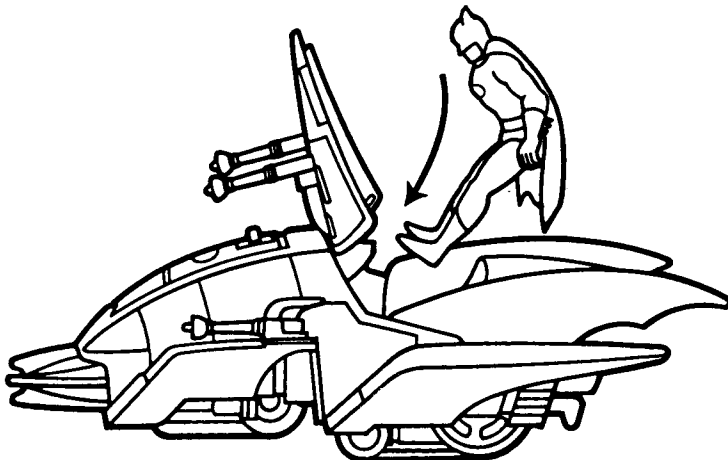

4 As you roll the vehicle, the "ice" drill will pretend to "cut through" anything in its path.

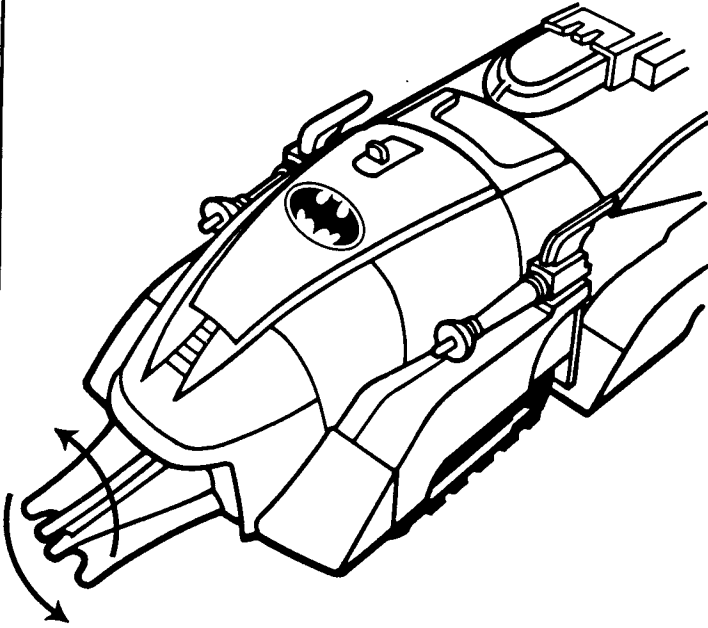

5 Pull lever back for action mode. Guns can be pivoted forward.

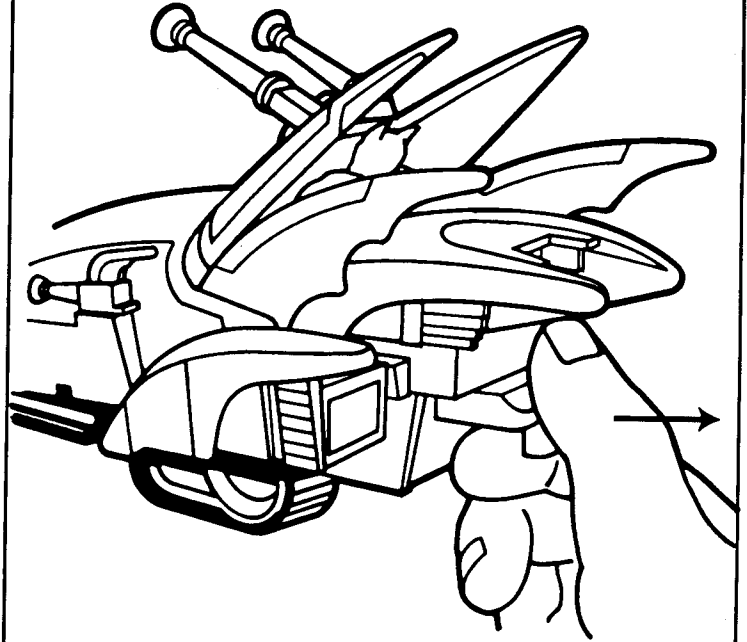

6 Load missile into launcher until it clicks. Press button to fire.

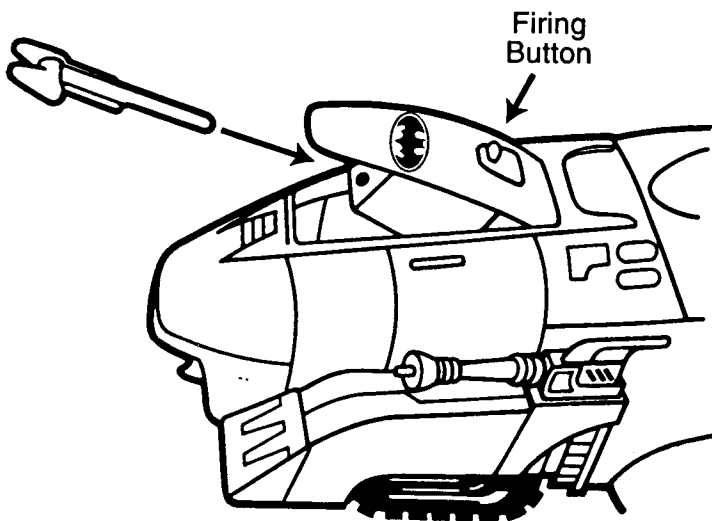

7 Return to ice drilling mode by retracting lever and closing canopy.

