

BATMAN[®] CROSSBOW

ASSEMBLY AND FIRING INSTRUCTIONS

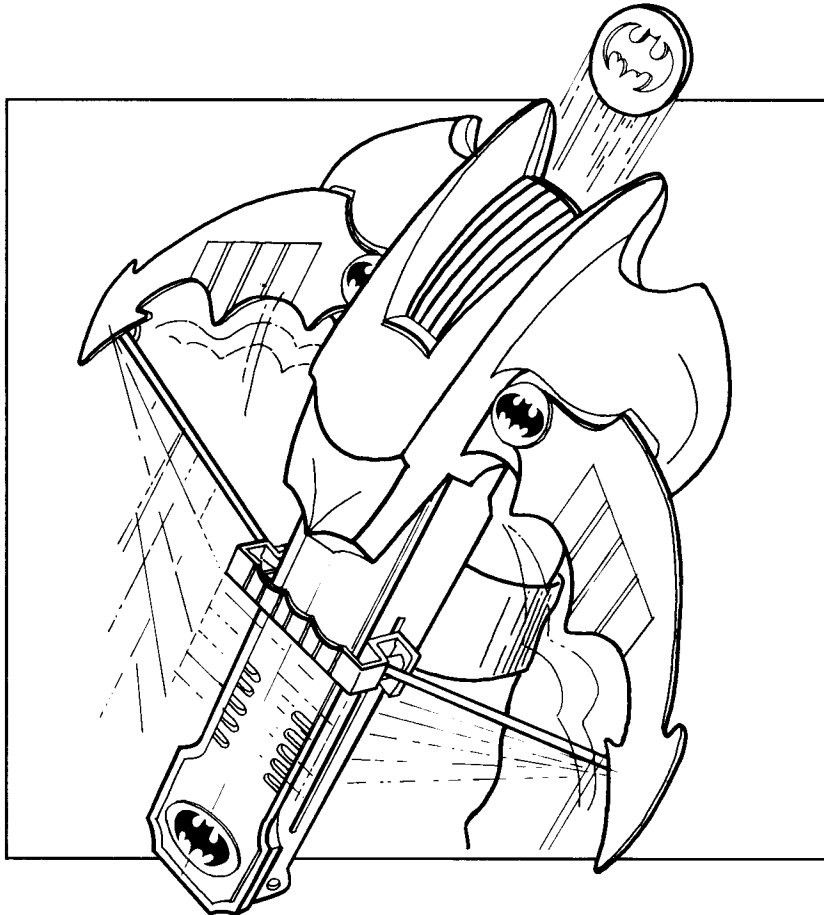
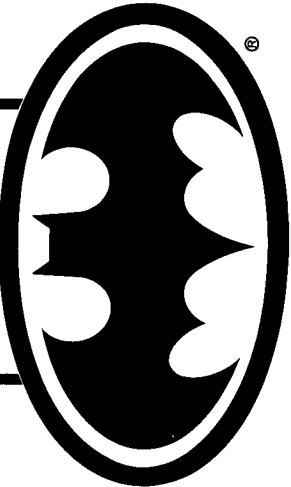

FIRING INSTRUCTIONS

1 Load the six weapon disks into slot on top of front cover.

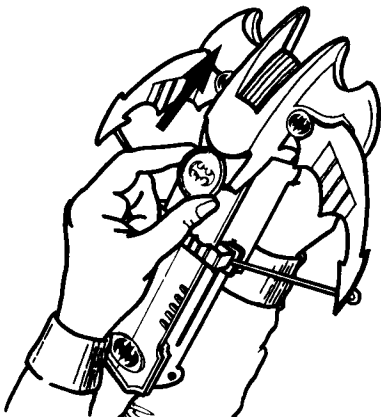

2 Using the finger grip pull back string to cock the bow. String does not have to be pulled back for rapid fire.

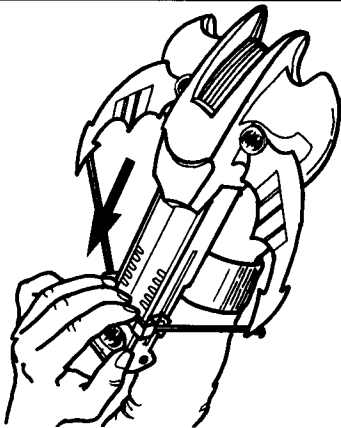

3 Squeeze trigger to fire one disk or continue to pull trigger to rapid fire all six.

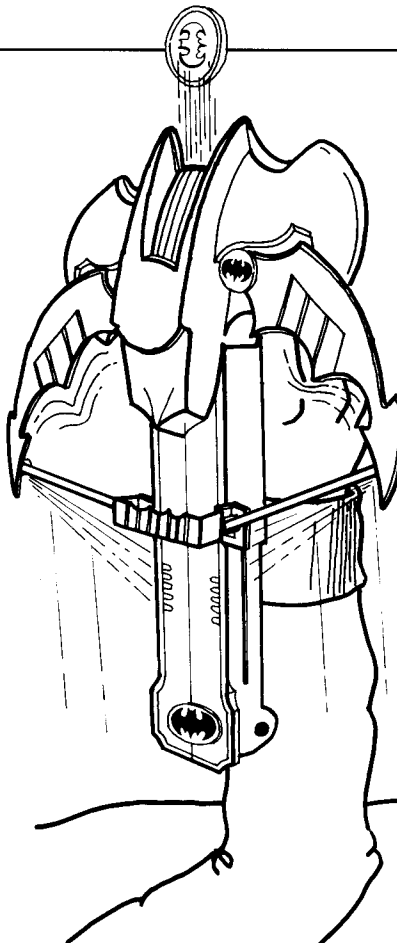

TM and © Indicate a trademark of DC Comics Inc. BATMAN, THE DARK KNIGHT and all related characters, accessories and indicia are trademarks of DC Comics Inc. © 1990. All Rights Reserved.

Kenner[®]*

*Kenner Products, a division of Tonka Corp.

ASSEMBLY INSTRUCTIONS

1.

Slide **FRONT COVER** over Crossbow body until it snaps into place. For proper operation, make sure that front cover is securely attached.

BOTTOM OF CROSSBOW

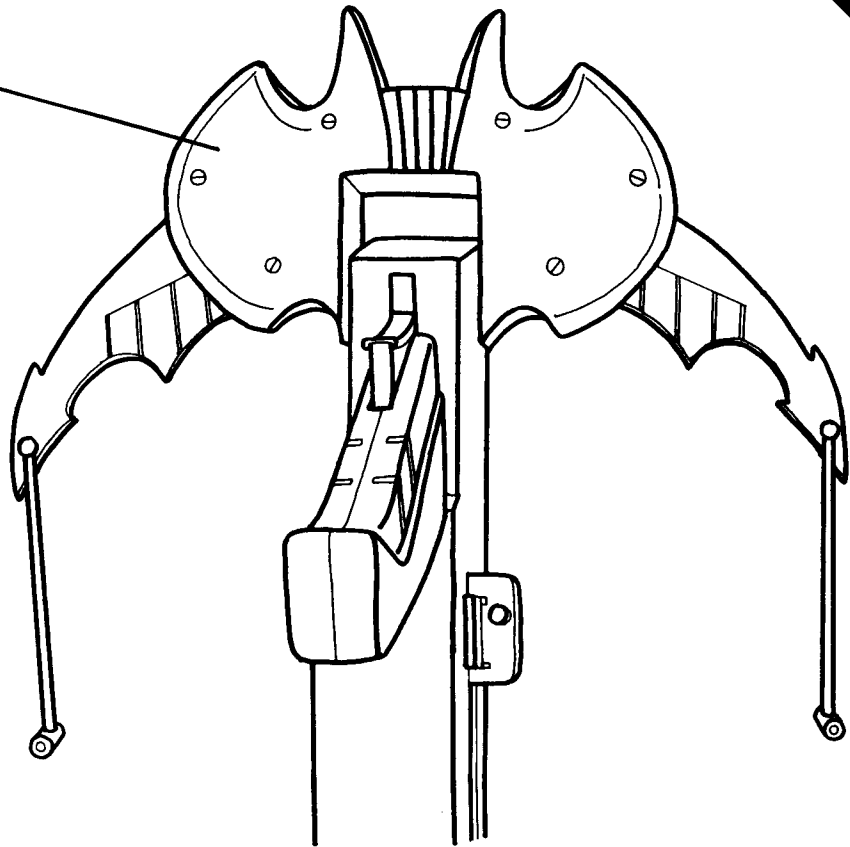

ONE TIME
ASSEMBLY

2.

Place **FINGER GRIP** over the ends of the two Crossbow "STRINGS" and snap into glides on each side of Crossbow body. Be sure finger grip faces front of weapon.

TOP OF CROSSBOW

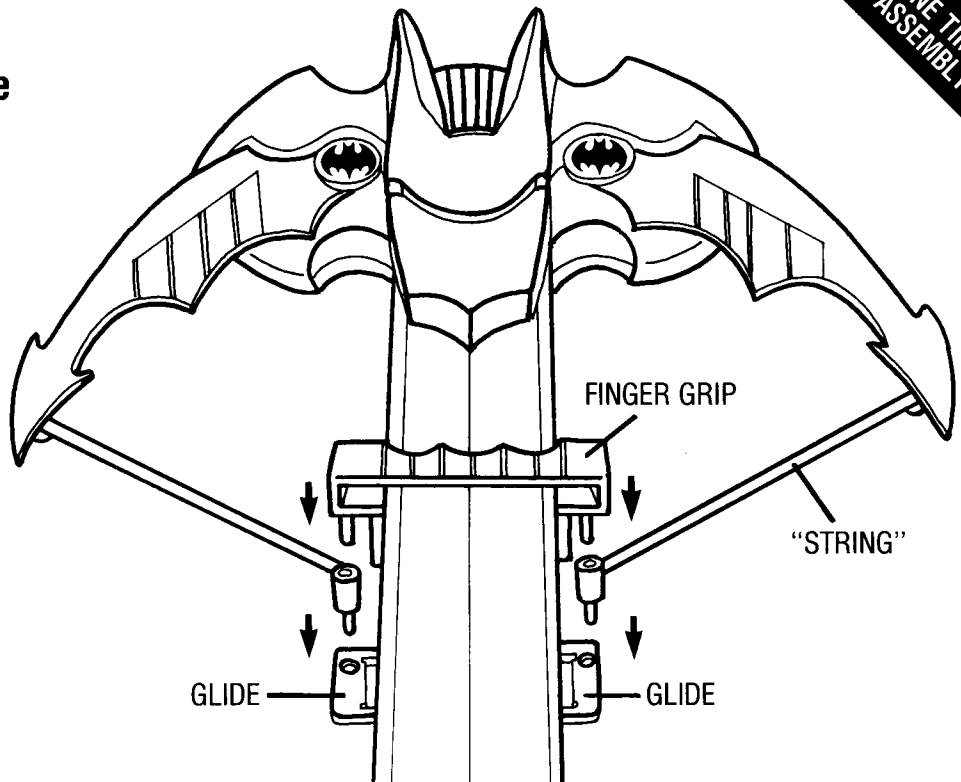

ONE TIME
ASSEMBLY