

**G.I. JOE**  **vs. Cobra** 

AGES 5+  
6505



**WARNING:**

CHOKING HAZARD—Small parts.  
Not for children under 3 years.



**BTR**  
**BUILT TO RULE!** <sup>TM</sup>

39 pcs.

ASSEMBLY REQUIRED.  
INCLUDES 1 KIT AND FIGURE.

**Cobra Raven** 

*Wild Weasel* <sup>TM</sup>

1.

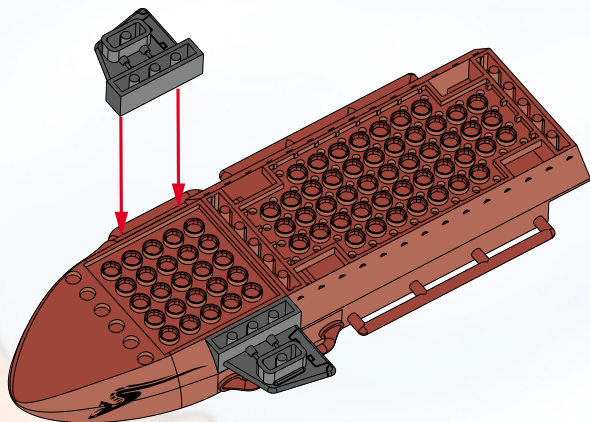
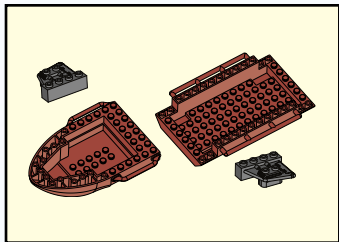

MODE 1: JET FIGHTER

2.

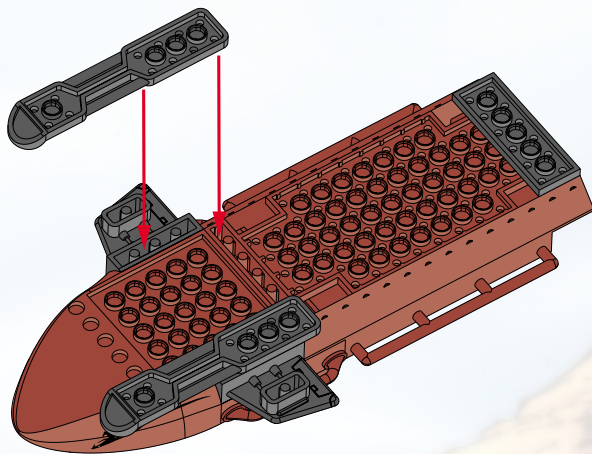
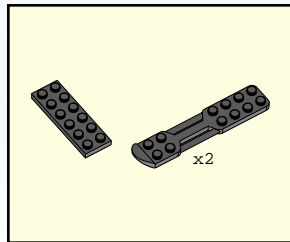

3.

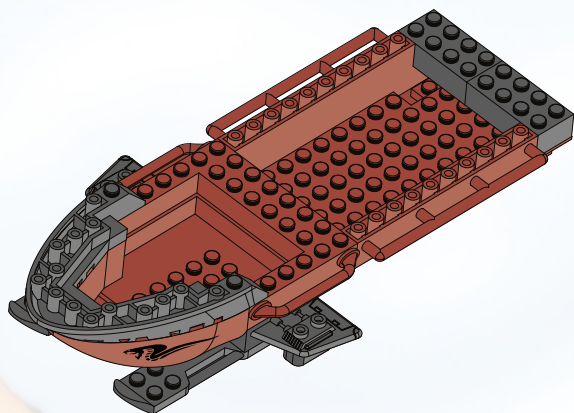
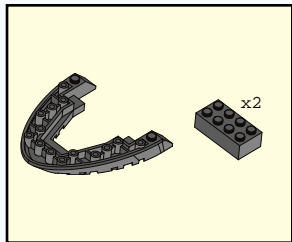

4.

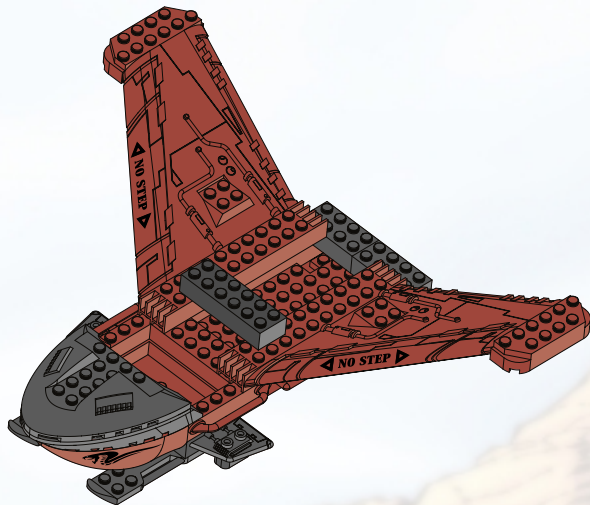
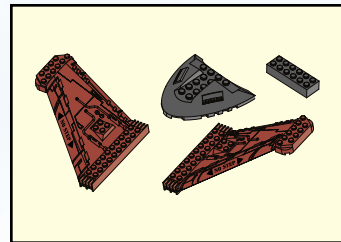

5.

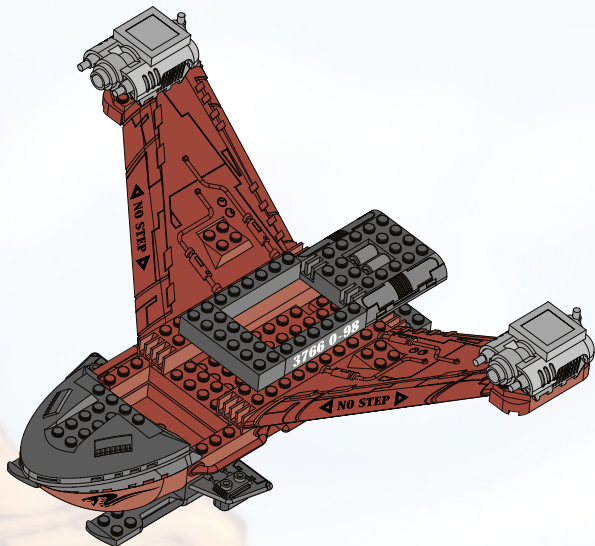
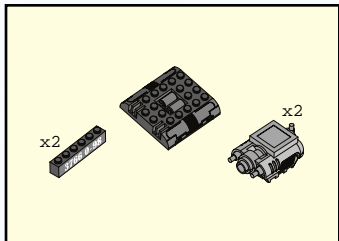

6.

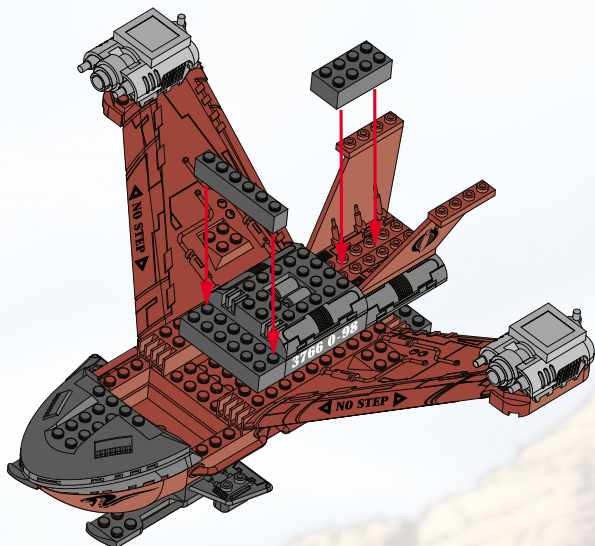
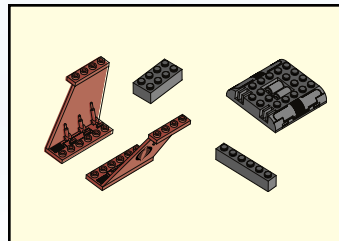

7.

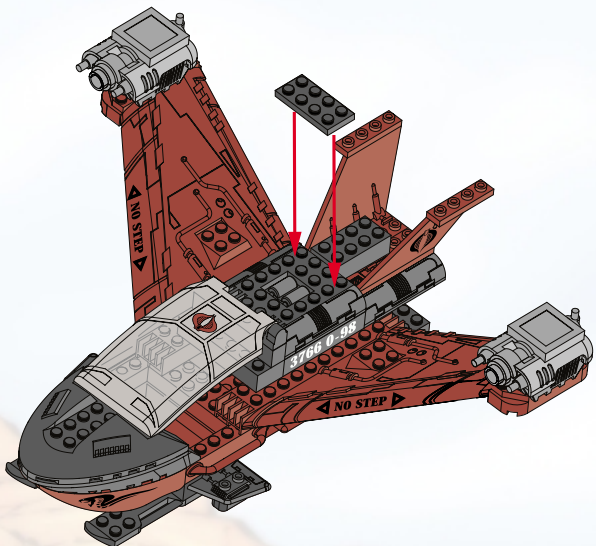
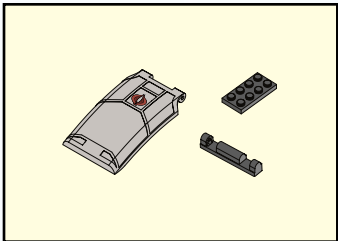
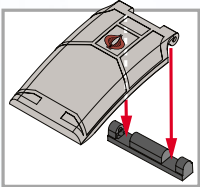

8.

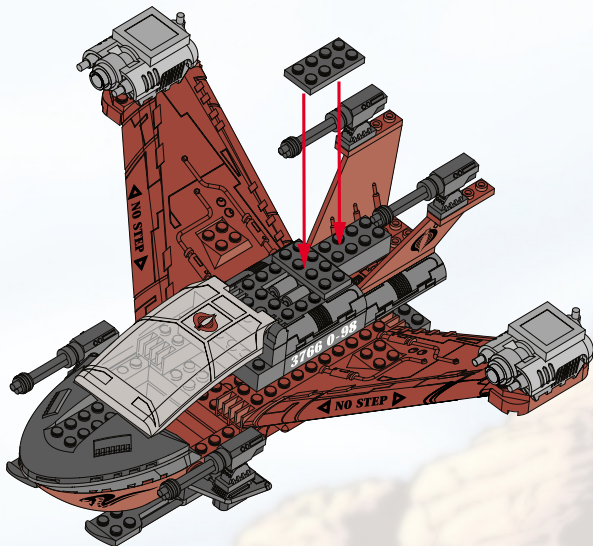
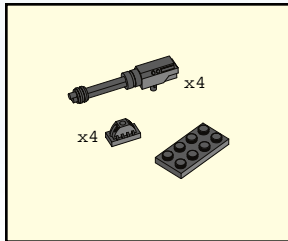
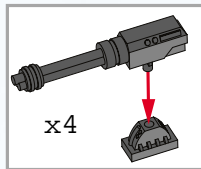

## LAUNCHING MISSILE!

1.

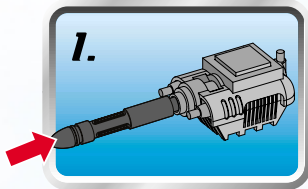

2.

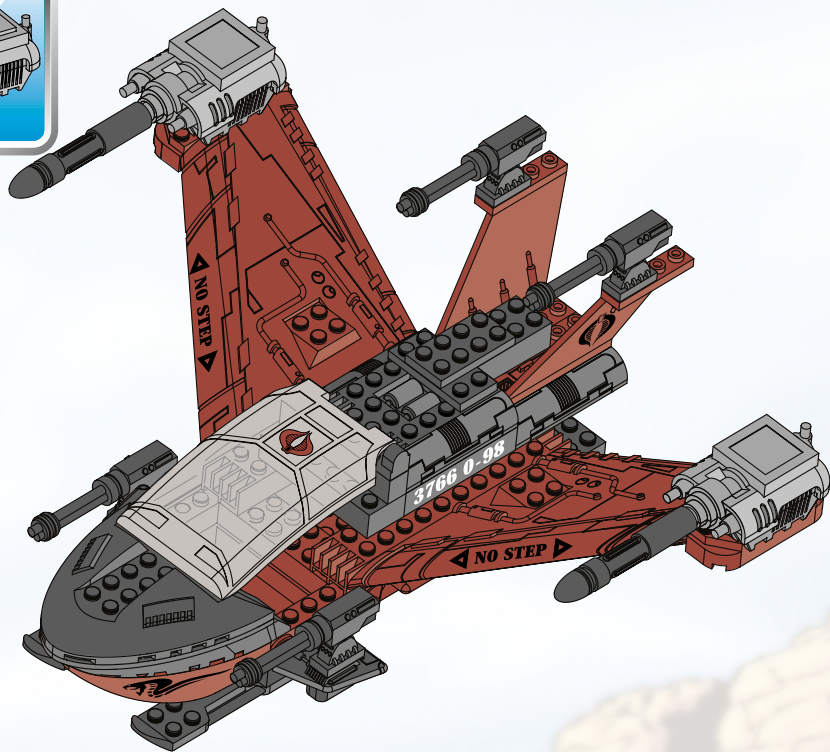
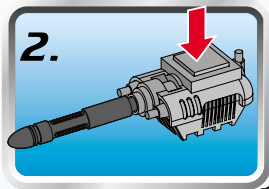

1.

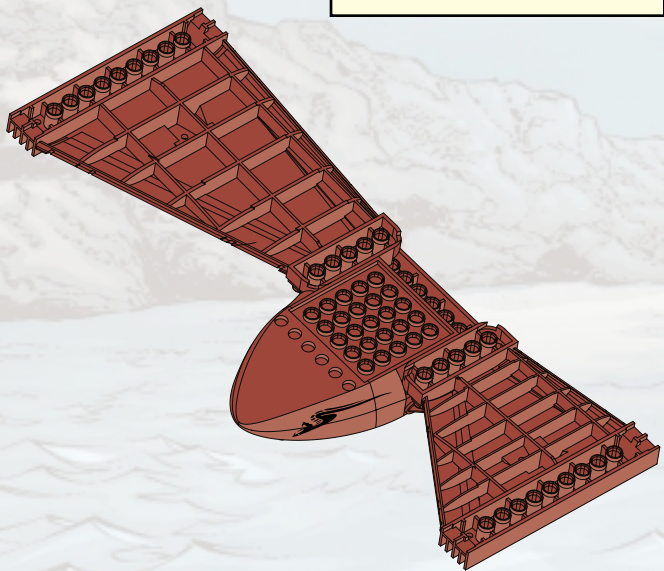
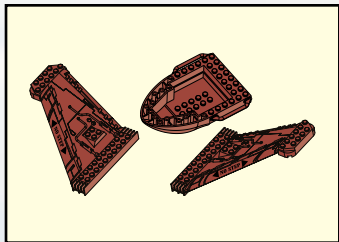

MODE 2: HYDROFOIL

2.

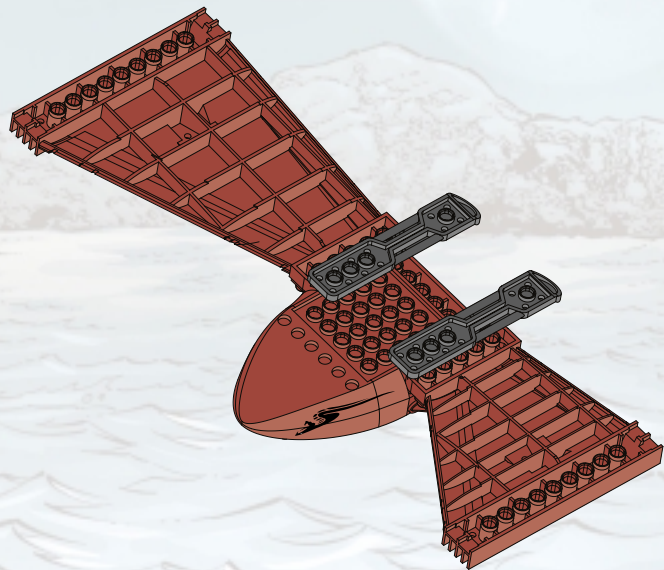
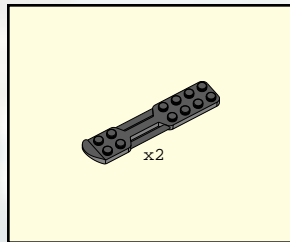

3.

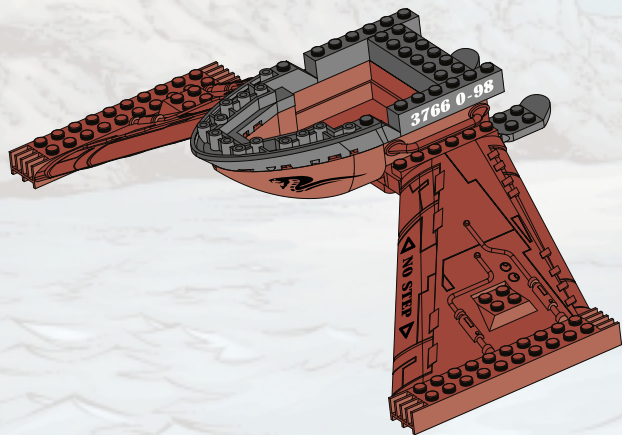
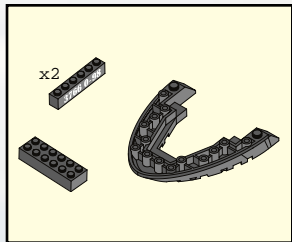

4.

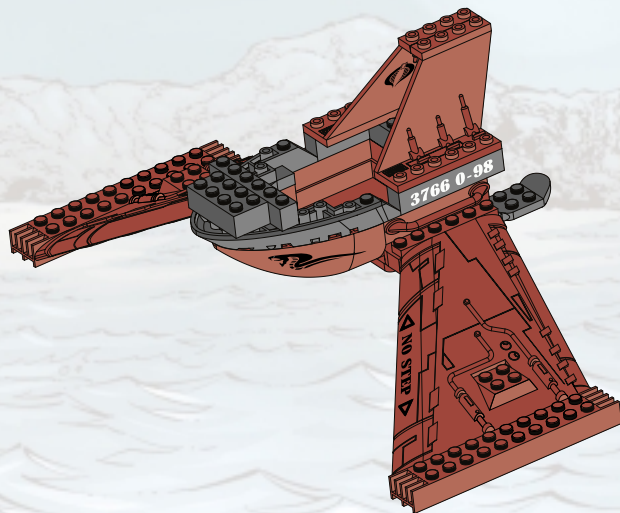
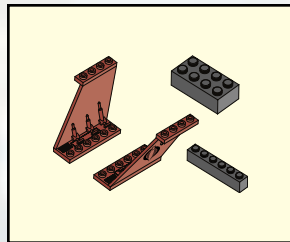



5.

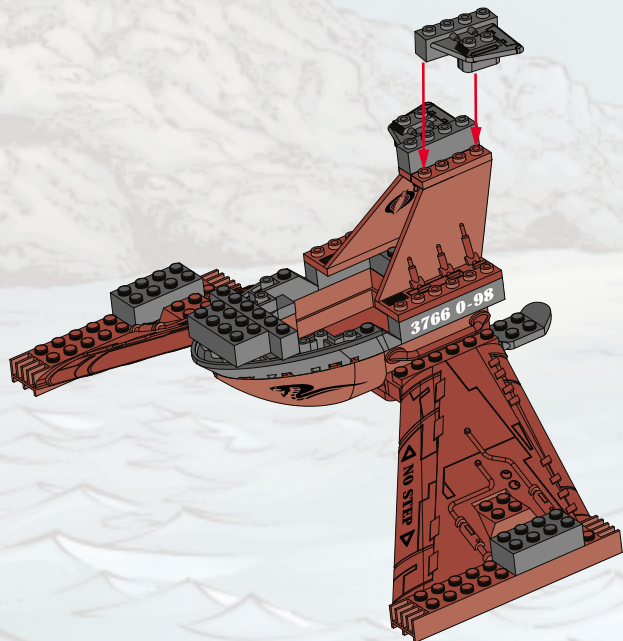
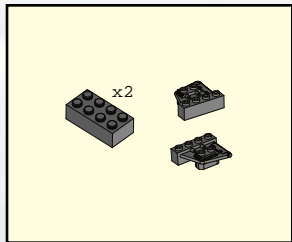

6.

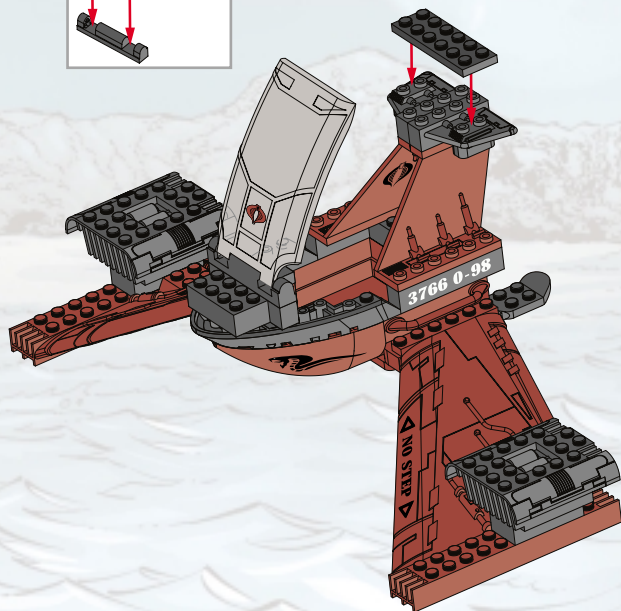
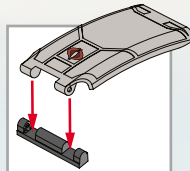
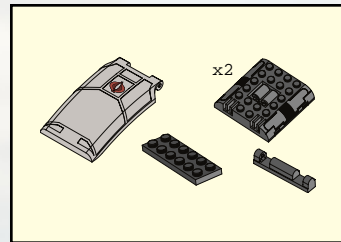

7.

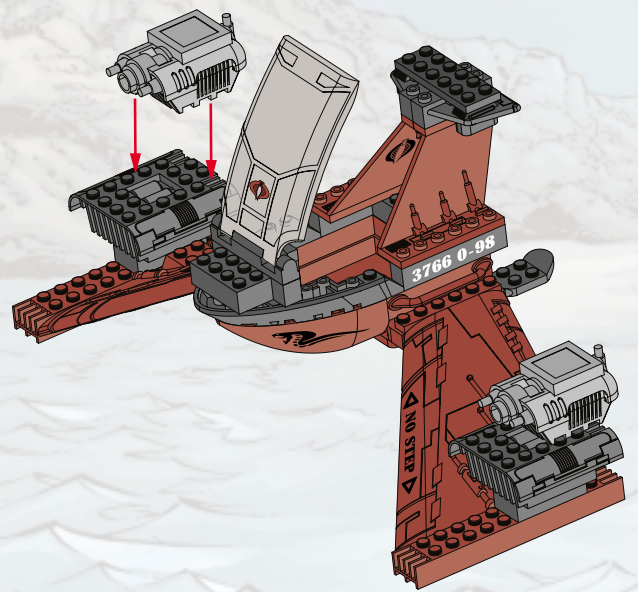
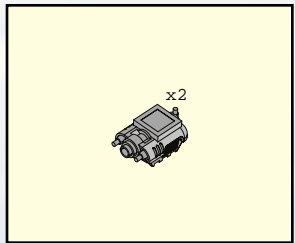

8.

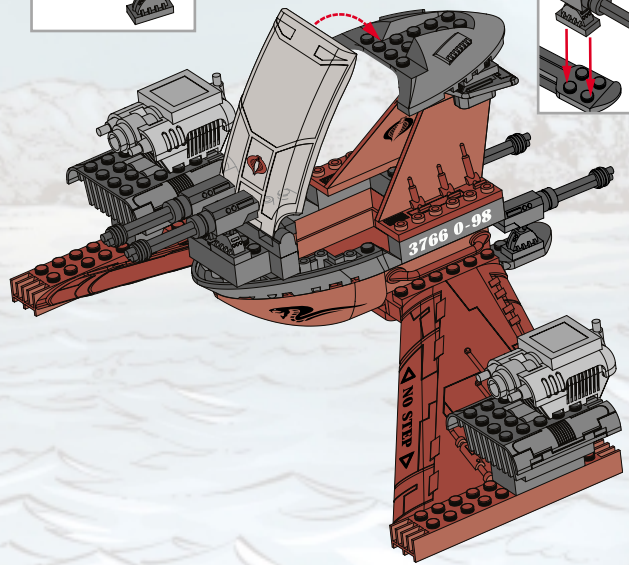
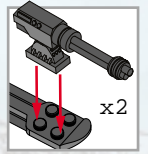
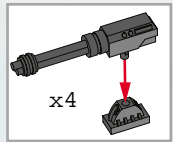
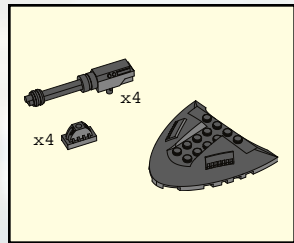

## LAUNCHING MISSILE!

1.

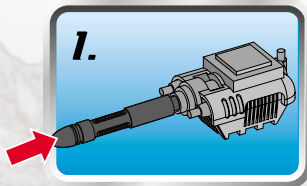

2.

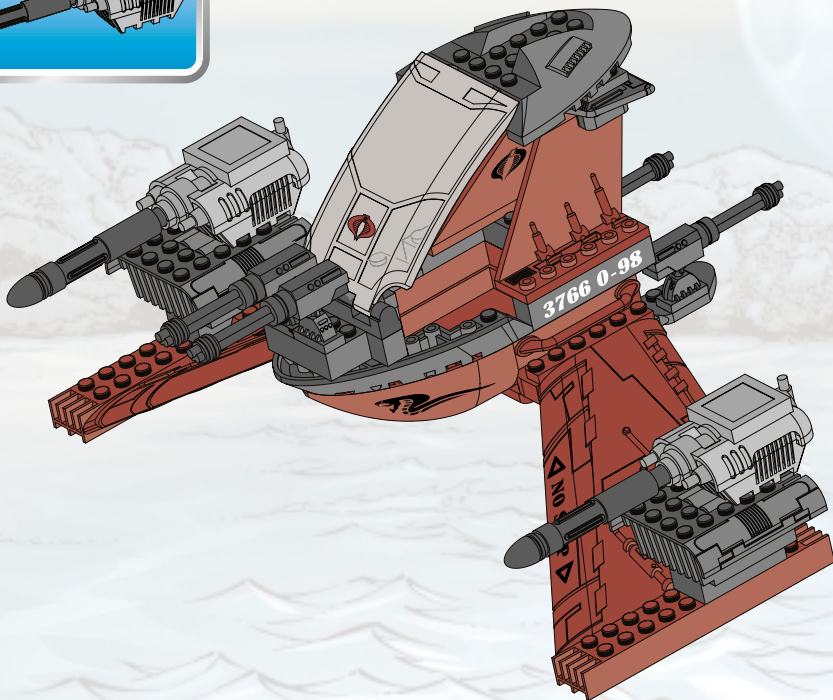
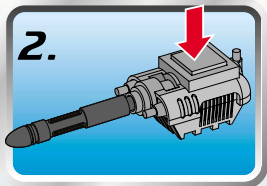

CODE NAME: COBRA RAVEN™



MODE 1: JET FIGHTER



MODE 2: HYDROFOIL

P/N 6241830001



Product and colors may vary.

© 2003 Hasbro.

All Rights Reserved.

\*denotes Reg. U.S. Pat. & TM Office.

Hasbro Canada, Longueuil, QC, Canada J4G 1G2.

Questions?

Call: 1-800-327-8264

Please keep company details for future reference.

Distributed in the United Kingdom by Hasbro UK Ltd., Caswell Way, Newport, Gwent NP9 0YH.

Distributed in Australia by Hasbro Australia Ltd., 570 Blaxland Road, Eastwood, NSW 2122,

Australia. Tel: (02) 9874-0999.

Distributed in New Zealand by Hasbro New Zealand Ltd., Albany Highways, Auckland, PO Box 100 940. North Shore Mail Centre, Auckland, New Zealand 1333. Tel: (09) 915-5200.



Not suitable for children under 36 months  
due to small parts, choking hazard.

[gijoe.com](http://gijoe.com)

FOR NEW PRODUCTS AND OFFERS

