



# Batmobile®

VEHICLE



© Kenner Products, A Division of Tonka Corporation, Cincinnati, Ohio 45202

BATMAN and all related elements are the property of DC Comics Inc. TM and © 1992 All Rights Reserved. 50231101 Printed in Mexico

## GETTING READY

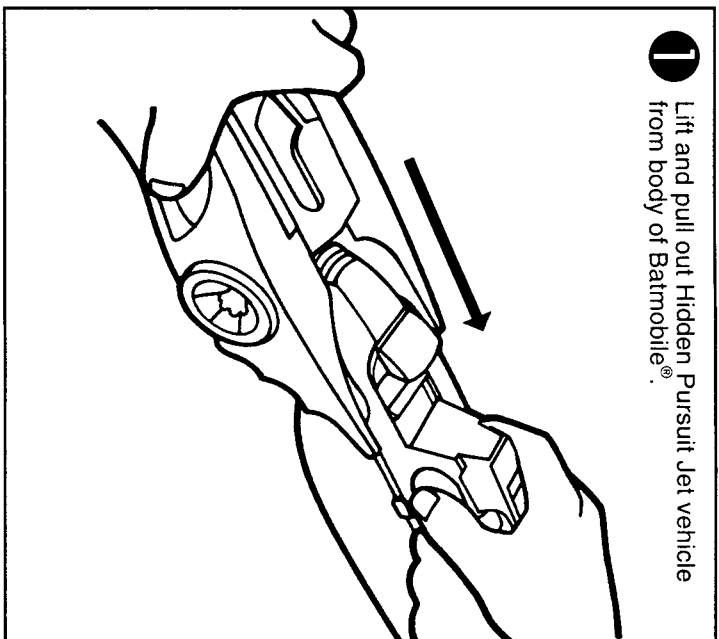

**1** Lift and pull out Hidden Pursuit Jet vehicle from body of Batmobile®.

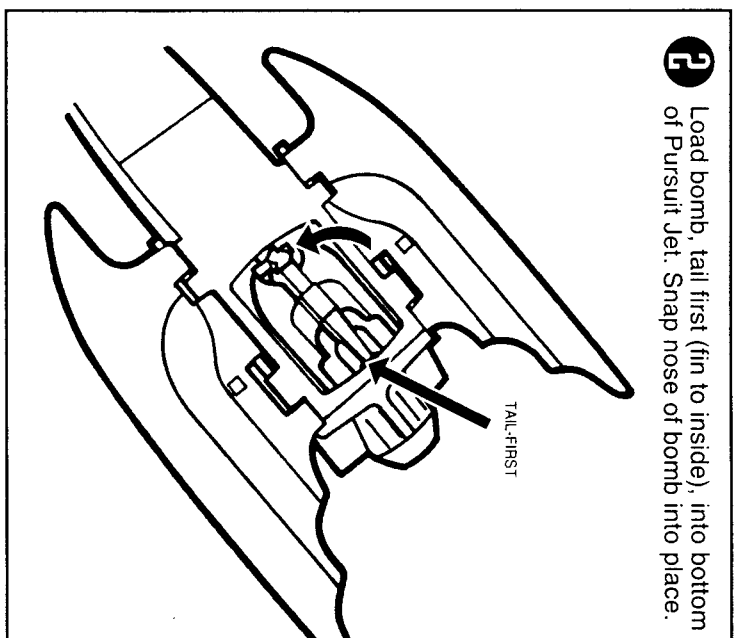

**2** Load bomb, tail first (fin to inside), into bottom of Pursuit Jet. Snap nose of bomb into place.

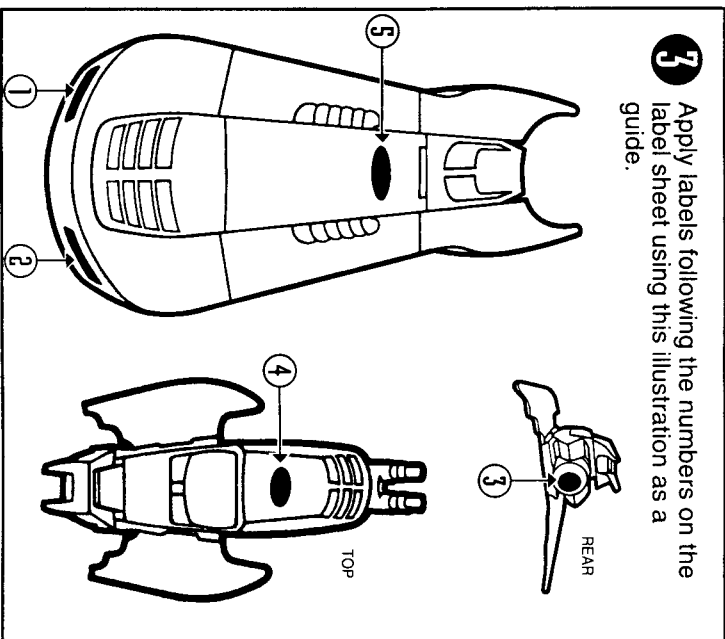

**3** Apply labels following the numbers on the label sheet using this illustration as a guide.

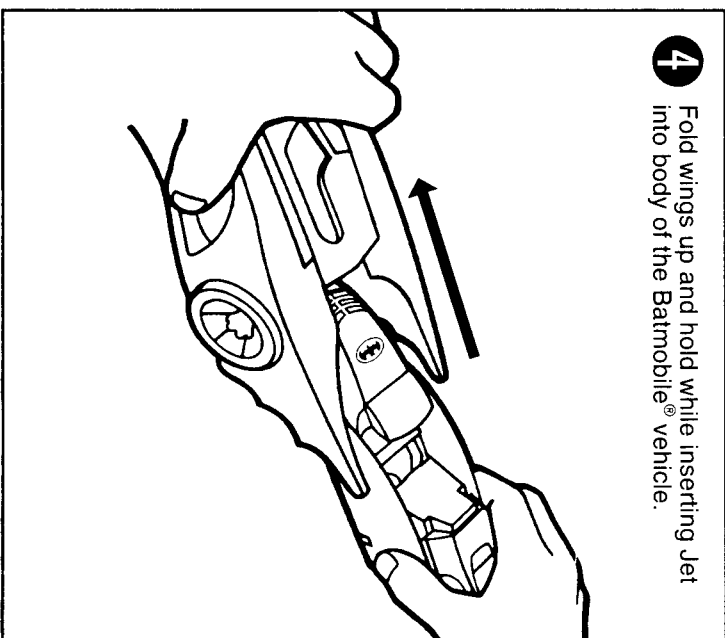

**4** Fold wings up and hold while inserting Jet into body of the Batmobile® vehicle.

**5** Raise canopy and place Batman® figure's legs under seat belt into driver's seat.

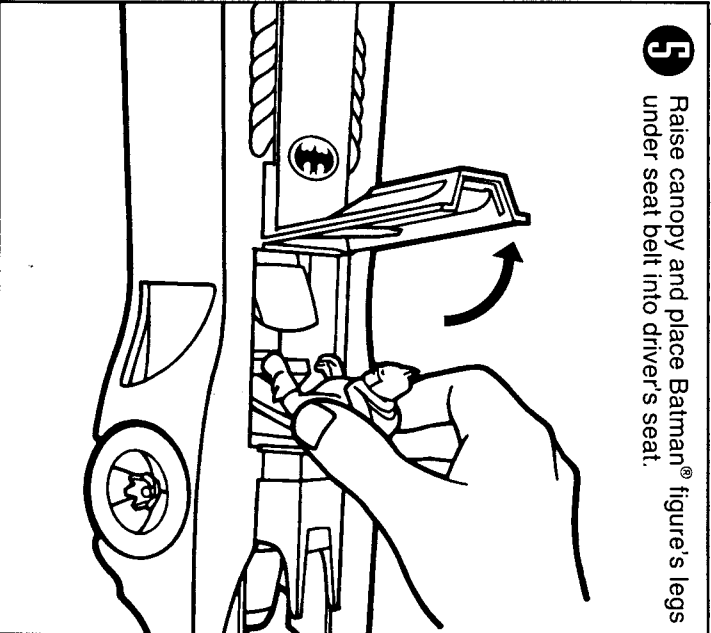

**6** Close canopy.

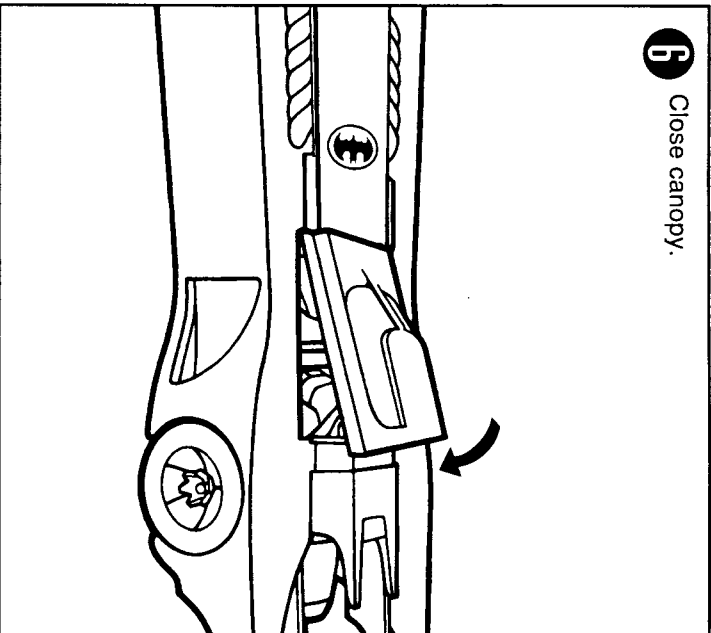

**7** Manually pull out front wheel shredders when the Batmobile® approaches danger. Push them back in place when danger is over.

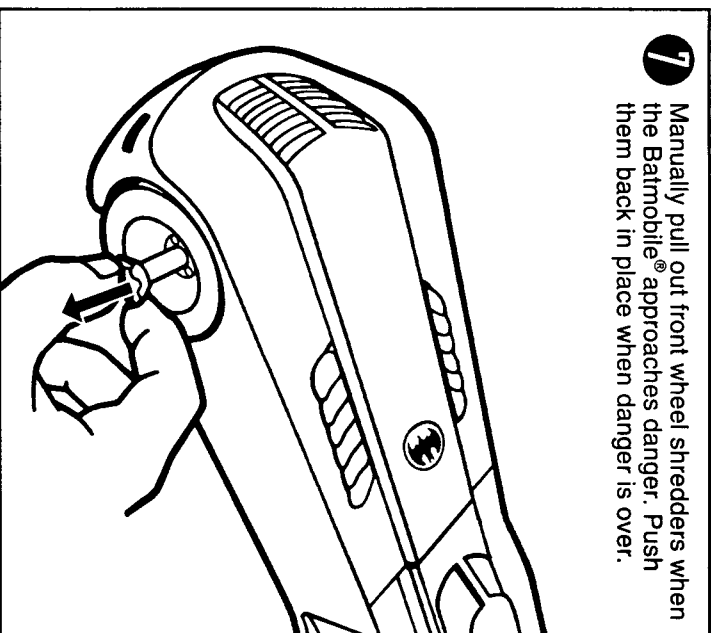

**8** For high flying action, lift and pull out Hidden Pursuit Jet vehicle for Batman® to search for villains.

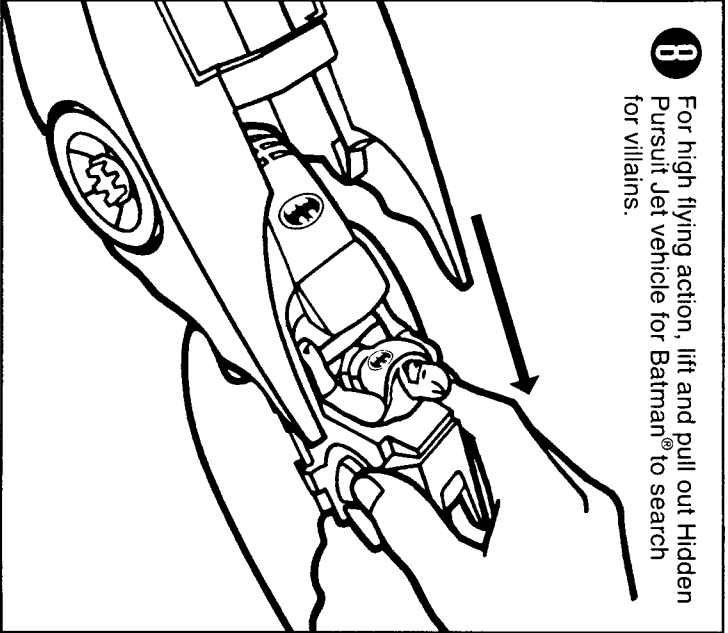

**9** When target is in sight, press on clear button to drop bomb.

