



TOY DOES NOT FLOAT - NOT INTENDED FOR WATER USE AGES 4 AND UP

BATMAN® FOREVER

BATBOAT™ VEHICLE

INSTRUCTIONS

1 Apply labels using the numbers on label sheet and these illustrations as a guide.

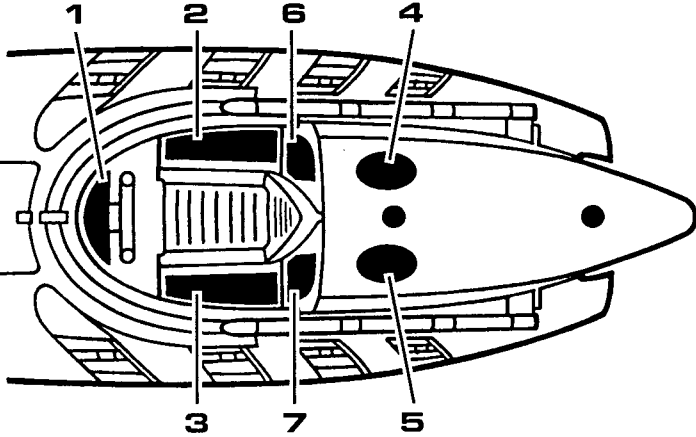

2 Snap tail fin into holes on back of boat as shown.

ONE-TIME ASSEMBLY
Once assembled, cannot be taken apart!

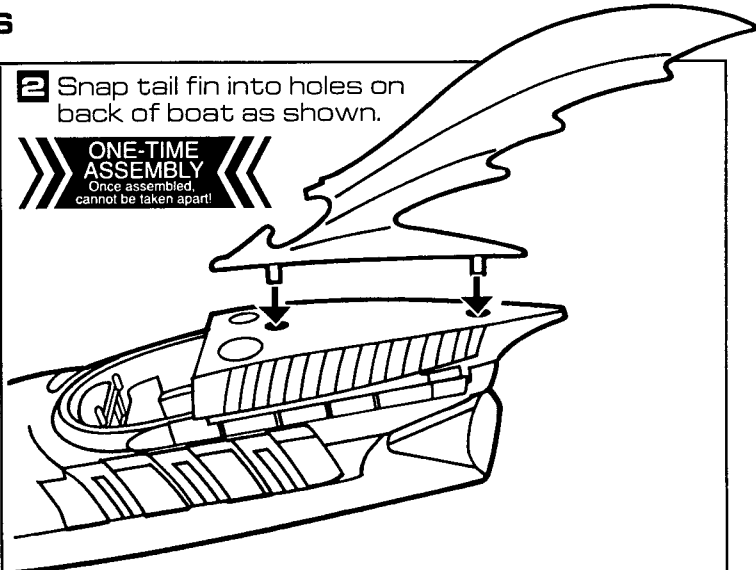

3 To transform boat to vehicle, first slide latch on bottom of vehicle down.

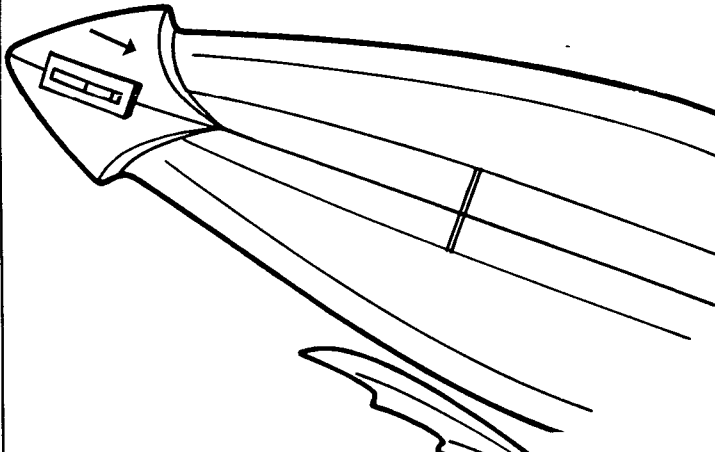

4 Move steering wheel to left position as shown:

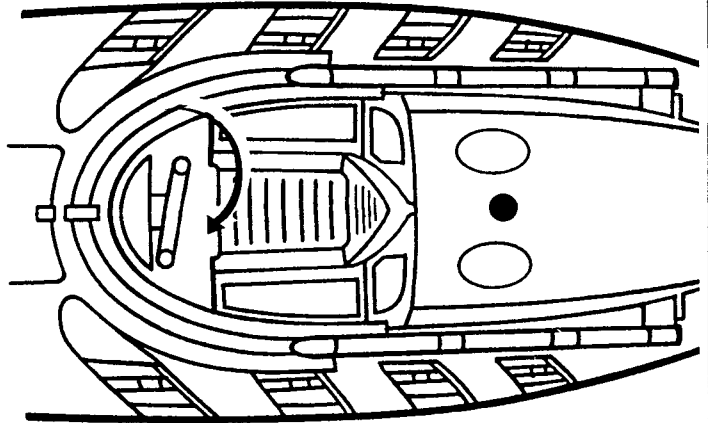

5 Rotate sides out as shown to complete the change.

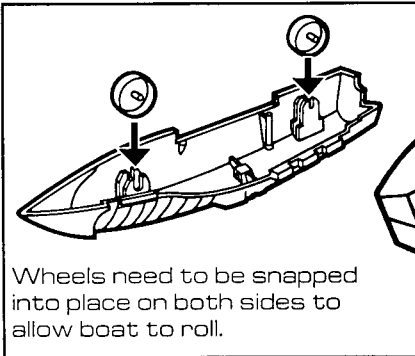

Wheels need to be snapped into place on both sides to allow boat to roll.

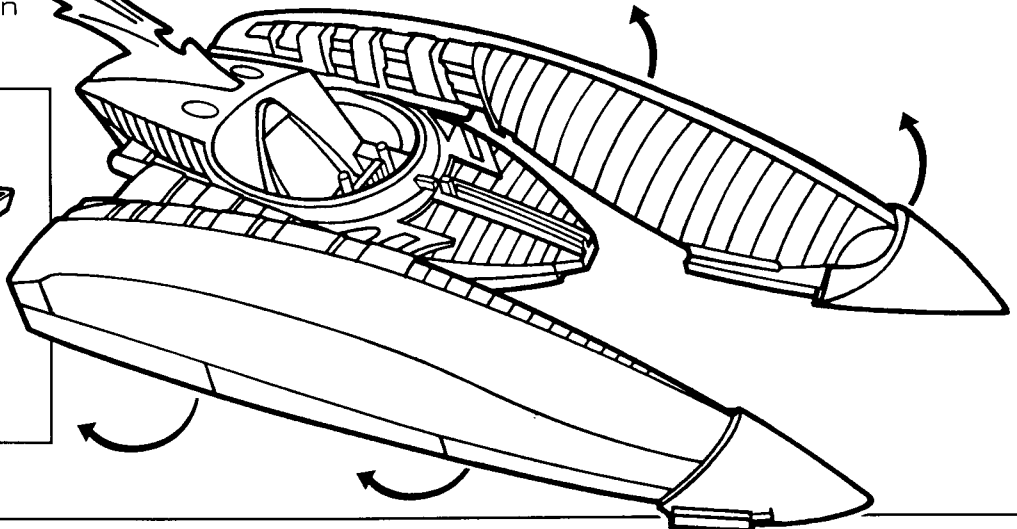

*© and © 1995 TONKA CORPORATION, a subsidiary of Hasbro, Inc., Pawtucket, Rhode Island 02862. All Rights Reserved.

BATMAN and all related elements are the property of DC Comics. TM and © 1995. All Rights Reserved.

522962.01
MADE IN CHINA

6 Load rocket into front of vehicle. To launch, pull back on the firing lever on top of vehicle.

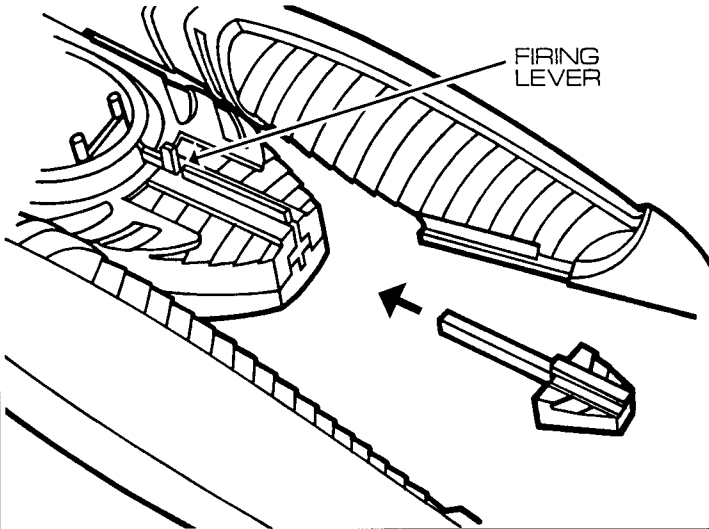

7 Place a Batman® Forever figure (sold separately) in cockpit as shown.

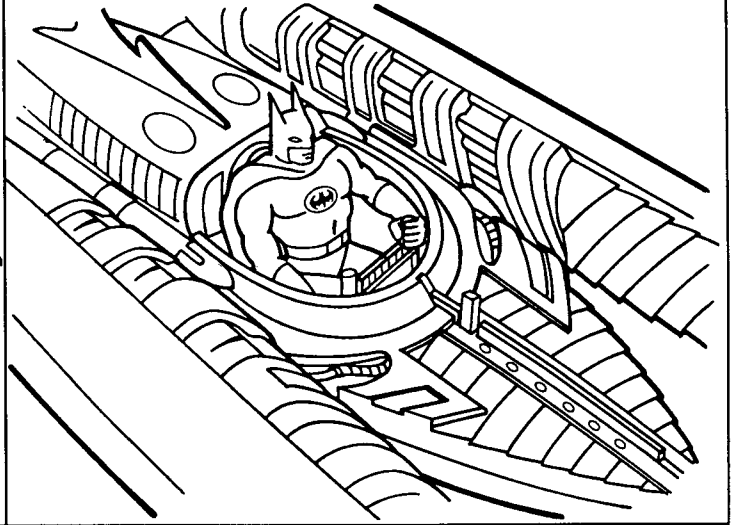

8 Battle blades on the sides of the vehicle can be extended manually by pushing in on the back.

NOTE: The battle blades must be closed before transforming vehicle back into a boat.

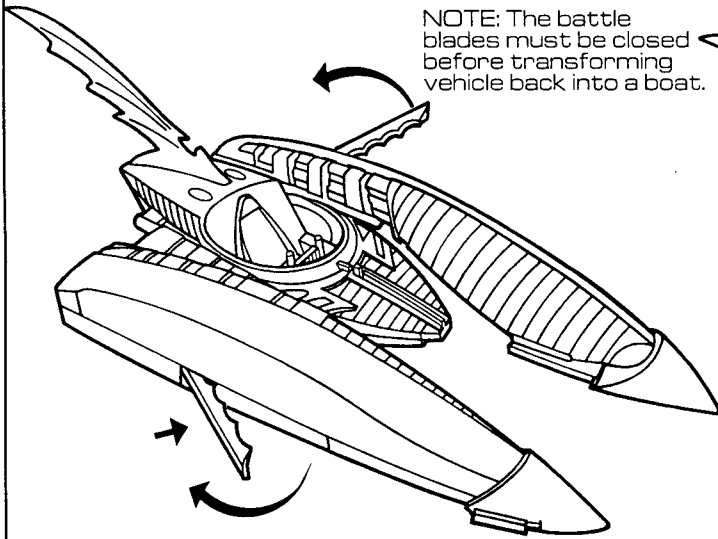

9 To transform vehicle back into a boat, close the sides as shown. The steering wheel must be to the left as shown in #4.

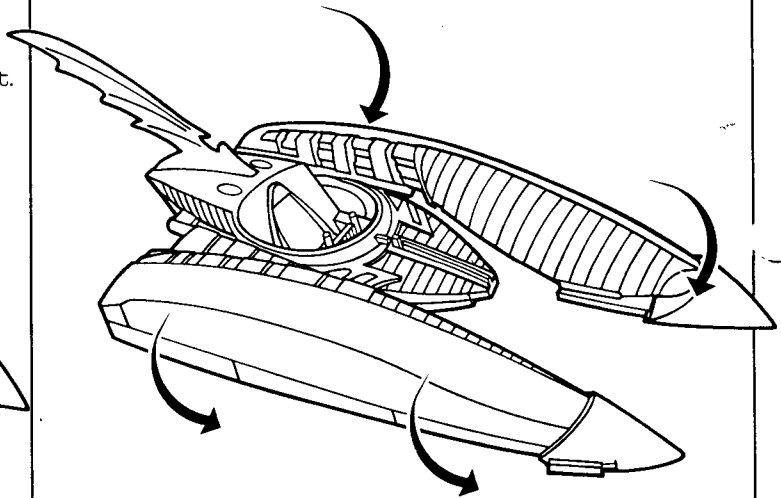

10 Once the sides are closed, move steering wheel back to the right position.

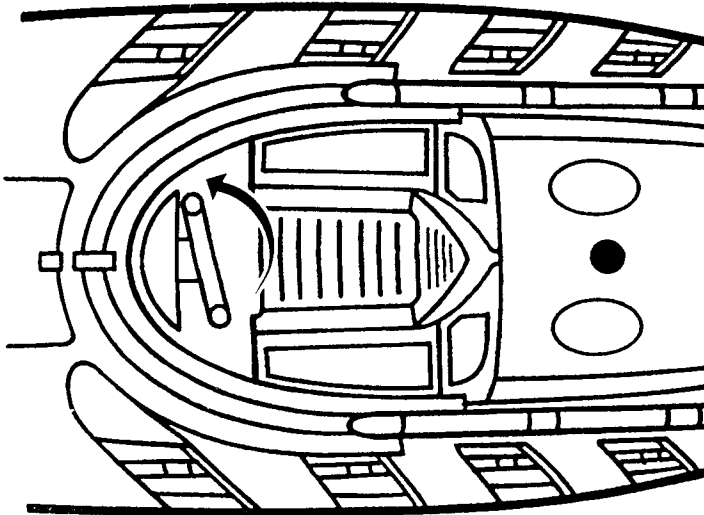

11 Slide latch on bottom of vehicle up.

