

**TIGER**  
ELECTRONICS  
AGES 8+

**BATTLEBOTS**

**CUSTOM SERIES**  
TOURNAMENT EDITION PLAYSET



Asst. No. 66689  
Item No. 66653  
200206470/WTI-01

## I. WELCOME TO BATTLEBOTS!

**BattleBots** combines science, sports, and scrap metal into the coolest competition ever! Does your **BattleBot** have what it takes to overcome all challengers in no-holds-barred robot combat? It's time to kick some Bot and find out!

To get the most enjoyment from your **BattleBot**, we recommend you read these instructions fully.

## II. ASSEMBLING YOUR BATTLEBOT

**BattleBots** competitors come from all walks of life, from rocket scientists to junkyard aficionados, but the one thing they all share in common is the desire to build a better Bot. Let's take a look at how your Bot goes together:

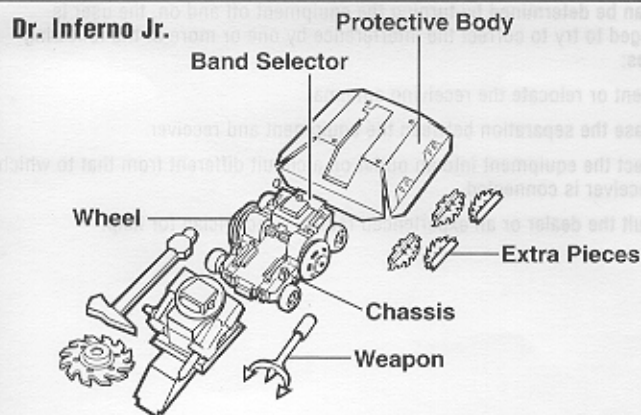
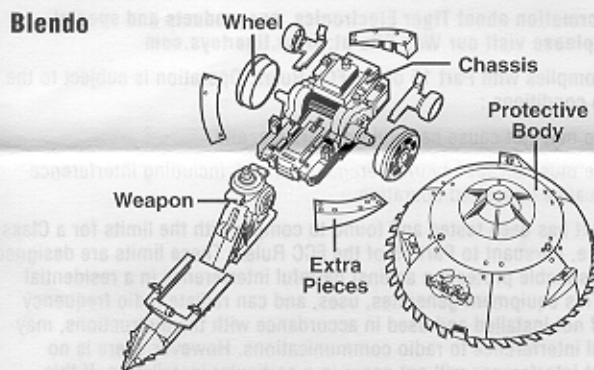

Start with the basic chassis and add the drive system by snapping the pieces together as shown.

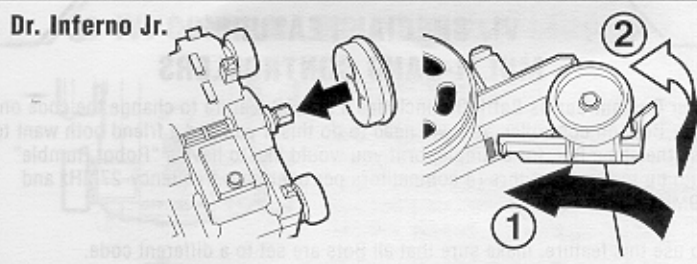
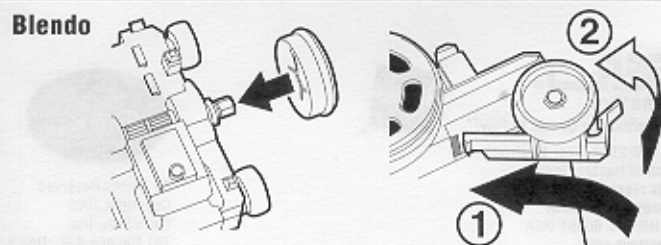

After the drive system is assembled, you can attach the Bot's offenses. Simply slide the attachment into place on the chassis as shown, and insert fully.

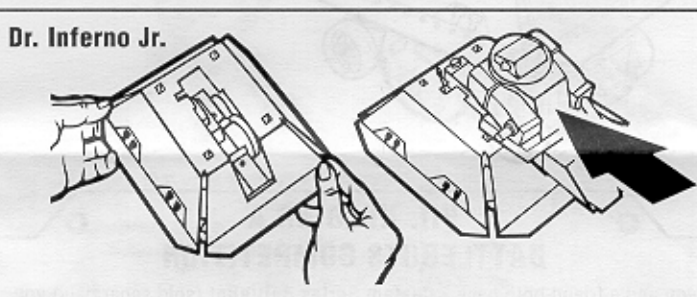
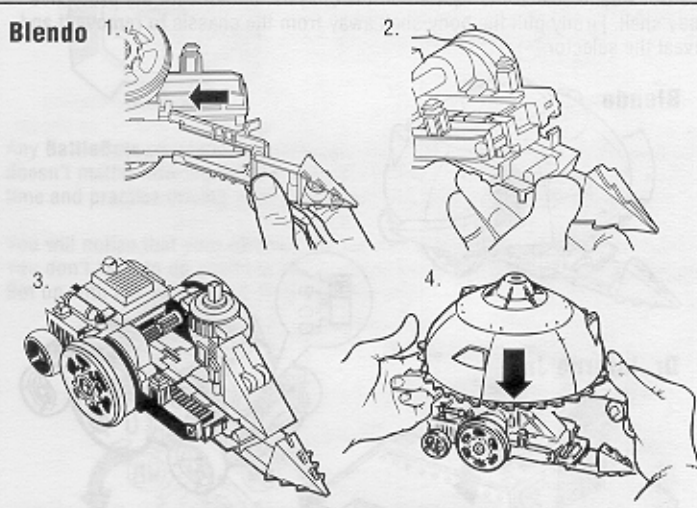

**NOTE:** Your **BattleBot** has a failsafe system. It will not operate unless the attachment is **FULLY** inserted.

Add the Bot's protective body shell by simply pressing it straight down onto the chassis as shown.

Finally, add the Bot's ablative defenses by attaching them to the body shell as shown. These pieces are designed to absorb impact and fly apart when the Bot is struck in combat.

If you have more than one Bot (sold separately) you can tinker with your Bot and try mixing and matching pieces!

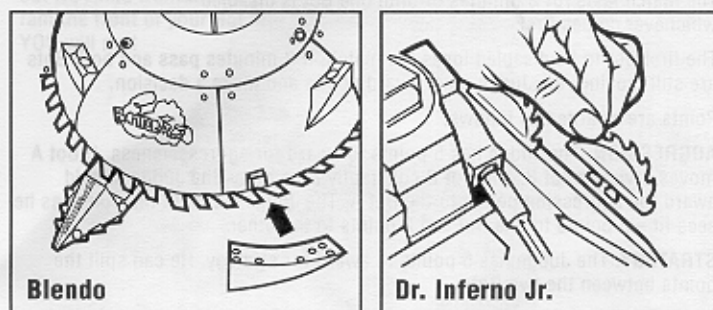

### III. INSERTING THE BATTERIES

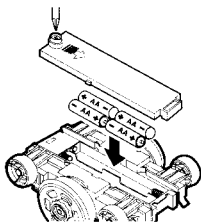
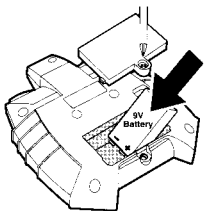

#### Controller

Using a Philips® screwdriver, remove the screw from the battery compartment door located on the bottom of the controller. Remove the battery compartment door.

Insert one 9V battery making sure to align the “+” and “-” as shown inside the battery compartment.

Replace the battery compartment door and screw into place.

#### Bot

Using a Philips® screwdriver, remove the screw from the battery compartment door located on the bottom of the Bot. Remove the battery compartment door.

Insert 4 x AA/LR6 batteries making sure to align the “+” and “-” as shown inside the battery compartment.

Replace battery compartment door and screw into place.

## CAUTION: TO AVOID BATTERY LEAKAGE

1. Be sure to insert the batteries correctly and always follow the toy and battery manufacturers' instructions;
2. Do not mix old and new batteries or alkaline, standard(carbon-zinc) or rechargeable (nickel-cadmium) batteries;
3. Always remove weak or dead batteries from the product.

## TO ENSURE PROPER FUNCTION:

- Battery installation should be done by an adult.
- Non-rechargeable batteries are not to be recharged.
- Rechargeable batteries are to be removed from the toy before being charged.  
(if removable)
- Rechargeable batteries are only to be charged under adult supervision.
- Only batteries of the same or equivalent type as recommended are to be used.
- The supply terminals are not to be short-circuited.
- Do not dispose of batteries in fire. Battery may explode or leak.

## IV. CONTROLLING YOUR BATTLEBOT

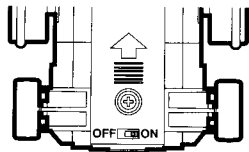

Turn your Bot on.

Once your Bot is turned on, quickly place it right side up on the playing surface. We recommend quarter-inch steel plate, but you could also use the floor of your kitchen, driveway, or garage.

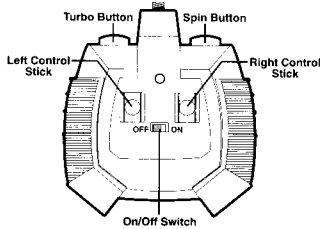

Turn your controller on.

Your **BattleBot** has a "tank style" controller. When you push on the left control stick, the left drive system will engage, and when you push on the right control stick, the right drive system will engage.

Any **BattleBots** competitor can tell you, CONTROL is the name of the game. It doesn't matter how big or how bad your Bot is if you can't drive. Take some time and practice driving your Bot before you think about competing!

You will notice that your offenses are geared directly into your drive system. You don't have to do anything special to operate your offenses—just line your Bot up with the victim, and drive right for him!

**Blendo**

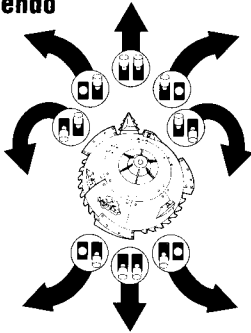

**Dr. Inferno Jr.**

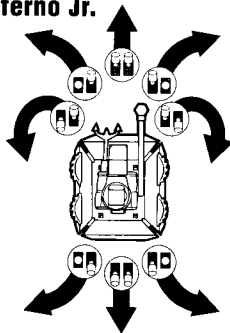

You will notice that your **BattleBot** controller also features a TURBO button and a SPIN button. We recommend these buttons for expert drivers only—but feel free to experiment and try it out!

## V. IMPACT SENSORS

You may have noticed by now the red light on top of your BattleBot. This is your damage meter.

- When the light is fully lit, your Bot is operating at 100% efficiency.
- If the light is flashing, your Bot has taken "virtual damage" and is in danger of a catastrophic shut-down!
- If the light goes out, your Bot has been disabled. Your controller will not work until you reset your Bot using the on/off switch. Turn the Bot off and back on again and you can continue playing.

The impact sensor is specially designed to register flips and hits from the sides, but NOT hits from the front or rear. What does that mean? It means if you can ram the front of your Bot into the side of your opponent, he will take a hit but YOU will not!

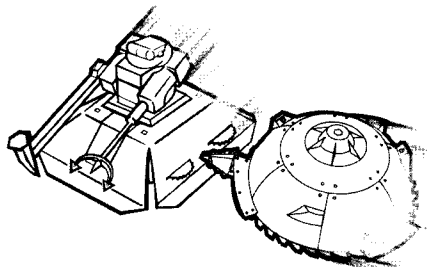

This is a good hit!

Be careful, though! There is always a chance your Bot will take damage from any collision. It's even possible to damage your own Bot from rough driving! Many a BattleBots champion has been taken out by old-fashioned bad luck!

**ATTENTION: IF YOUR BOT DOES NOT SEEM TO BE WORKING PROPERLY, RESET YOUR IMPACT SENSOR: TURN YOUR BOT OFF, WAIT A FEW SECONDS, THEN TURN IT ON AGAIN.**

## VI. SPECIAL FEATURE— MULTI-BAND CONTROLLERS

Your **Custom Series BattleBot** includes a special feature to change the code on your Bot and controller. You will need to do this if you and a friend both want to use the same Bot, for example, or if you would like to have a "Robot Rumble" with up to 8 competitors (4 competitors per operating frequency—27MHz and 49MHz).

To use this feature, make sure that all Bots are set to a different code.

The controller's band selector is located on the back of the controller. Turn it over and select the ABCD band.

The Bot's band selector is located on the chassis, underneath the protective body shell. Firmly pull the body shell away from the chassis to remove it and reveal the selector.

**Blendo**

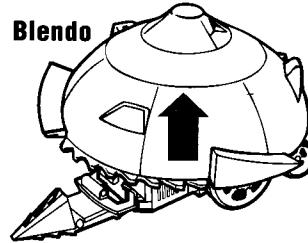

**Dr. Inferno Jr.**

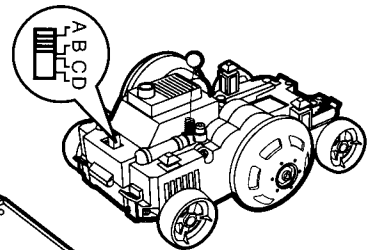
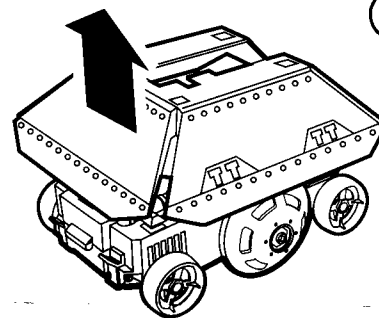

## VII. HOLDING A BATTLEBOTS COMPETITION

If you and a friend both have a **Custom Series BattleBot** (sold separately) you can compete head to head. Here are the basic rules:

- You will need two competitors and at least one Judge.
- You will need a flat surface for your playing arena. For **Custom Series Playset BattleBots**, an area of at least 5 feet by 5 feet is best.
- The Judge will need a stopwatch or a clock to time the match.
- Place the two Bots about 5 feet apart, facing each other, and turn them on.
- Turn on your controllers but do not start fighting—yet!
- The Judge will officially start the match (and the clock) and both players can begin battling.
- The match lasts for 3 minutes or until one Bot is disabled—whichever comes first.
- The first Bot to be disabled loses the match. If 3 minutes pass and both Bots are still moving, the Judge must award points and make a decision.
- Points are awarded as follows:

**AGGRESSION.** The Judge has 5 points to award for aggressiveness. If Bot A moves towards Bot B, and Bot B constantly runs away, the Judge should award the aggression points to the Bot A. The Judge can split the points as he sees fit—3 points to one Bot and 2 points to the other.

**STRATEGY.** The Judge has 5 points to award for strategy. He can split the points between the two Bots.

**DAMAGE.** The Judge has 5 points to award for damage. If Bot A knocked a lot of pieces off of Bot B, Bot A should receive more points. The Judge can split the points as he sees fit.

- The winner of a Decision is the Bot with more points.

## VIII. 90 DAY LIMITED WARRANTY

Tiger Electronics (Tiger) warrants to the original consumer purchaser of this product that the product will be free from defects in materials or workmanship for 90 days from the date of original purchase. This warranty does not cover

damages resulting from accident, negligence, improper service or use or other causes not arising out of defects in materials or workmanship.

During this 90-day warranty period, the product will either be repaired or replaced (at Tiger's option) without charge to the purchaser, when returned with proof of the date of purchase to either the dealer or to Tiger.

Product returned to Tiger without proof of the date of purchase or after the 90-day warranty period has expired, but prior to one year from the original date of purchase, will be repaired or replaced (at Tiger's option) for a service fee of U.S.\$15.75 per Bot. Payments must be by check or money order payable to Tiger Electronics.

**The foregoing states the purchaser's sole and exclusive remedy for any breach of warranty with respect to the product.**

All product returned must be shipped prepaid and insured for loss or damage to:

**Hasbro Inc.**  
Consumer Returns A-847  
1027 Newport Ave. Pawtucket, RI 02862

The product should be carefully packed in the original box or other packing materials sufficient to avoid damage during shipment. Include a complete written description of the defect, a check if product is beyond the 90-day warranty period, and your printed name, address and telephone number.

**THIS WARRANTY IS IN LIEU OF ALL OTHER WARRANTIES AND NO OTHER REPRESENTATIONS OR CLAIMS OF ANY NATURE SHALL BE BINDING ON OR OBLIGATE TIGER IN ANY WAY. ANY IMPLIED WARRANTIES APPLICABLE TO THIS PRODUCT, INCLUDING WARRANTIES OF MERCHANTABILITY AND FITNESS FOR A PARTICULAR PURPOSE, ARE LIMITED TO THE NINETY (90) DAY PERIOD DESCRIBED ABOVE. IN NO EVENT WILL TIGER BE LIABLE FOR ANY SPECIAL, INCIDENTAL, OR CONSEQUENTIAL DAMAGES RESULTING FROM POSSESSION, USE, OR MALFUNCTION OF THIS TIGER PRODUCT.**

Some states do not allow limitations as to how long an implied warranty lasts and/or exclusions or limitations of incidental or consequential damages, so the above limitations and/or exclusions of liability may not apply to you. This warranty gives you specific rights, and you may also have other rights which vary from state to state.

**For more information about Tiger Electronics, our products and special promotions, please visit our Web Site at: [www.tigertoys.com](http://www.tigertoys.com)**

This device complies with Part 15 of the FCC Rules. Operation is subject to the following two conditions :

- (1) this device may not cause harmful interference, and
- (2) this device must accept any interference received, including interference that may cause undesired operation.

This equipment has been tested and found to comply with the limits for a Class B digital device, pursuant to Part 15 of the FCC Rules. These limits are designed to provide reasonable protection against harmful interference in a residential installation. This equipment generates, uses, and can radiate radio frequency energy and, if not installed and used in accordance with the instructions, may cause harmful interference to radio communications. However, there is no guarantee that interference will not occur in a particular installation. If this equipment does cause harmful interference to radio or television reception, which can be determined by turning the equipment off and on, the user is encouraged to try to correct the interference by one or more of the following measures:

1. Reorient or relocate the receiving antenna.
2. Increase the separation between the equipment and receiver.
3. Connect the equipment into an outlet on a circuit different from that to which the receiver is connected.
4. Consult the dealer or an experienced radio TV technician for help.

**TIGER**  
**ELECTRONICS**  
*Where Technology Comes to Play!™*

®, TM, & © 2002 Tiger Electronics,  
a division of Hasbro, Inc.  
All rights reserved.  
980 Woodlands Parkway  
Vernon Hills, IL 60061 USA  
[www.tigertoys.com](http://www.tigertoys.com)

Printed in China



All Rights Reserved  
Copyright 2002  
BattleBots, Inc.  
701 DeLong Ave., Unit K  
Novato, CA 94945  
[www.battlebots.com](http://www.battlebots.com)