

Includes unassembled BEYBLADE® top, launcher, and ripcord.
Assembly required. No tools needed.

⚠ WARNING: Do not use BEYBLADE tops or BEYSTADIUM™ on tables or other elevated surfaces.

BEYBLADE tops/BEYSTADIUM are intended to be used on the floor. Do not lean over the stadium when BEYBLADE tops are in play. BEYBLADE tops may bounce up and hit eye or face.

- Before assembly and playing, please read instructions. Please keep these instructions for future reference.
- Discard plastic bags immediately.

PARTS:

Bit Protector,
Attack Ring,
Weight Disk,
Spinning Core,
Stickers.

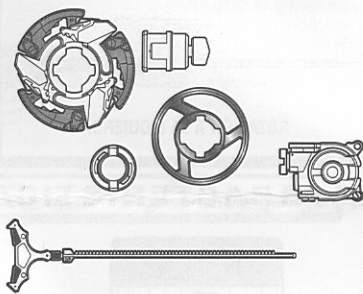

BEYSTADIUM sold separately.

BUILD:

1 Apply decals.

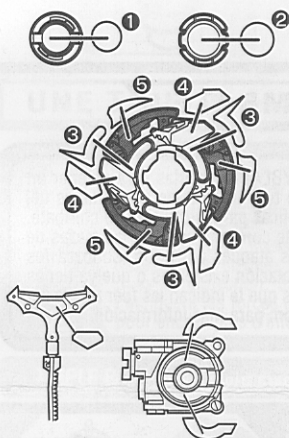

2 Be sure Weight Disk is right side up.

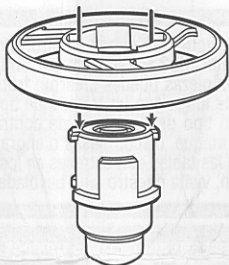

3 Be sure to attach Attack Ring in the correct direction.

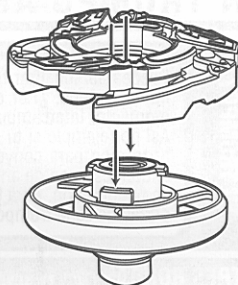

4 Holding Spinning Core in place, align grooves on Bit Protector with tabs on Core. Lock Bit Protector with Bit Key by turning right.

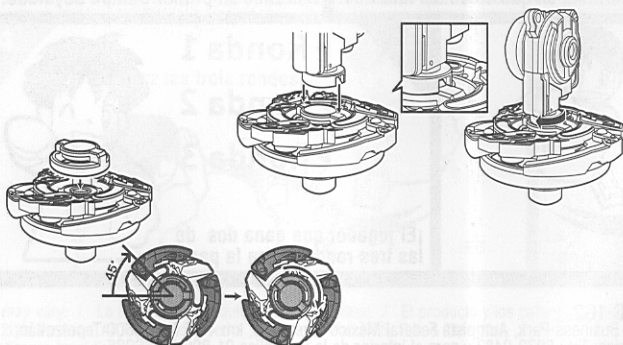

5 Your BEYBLADE top is now ready for battle!

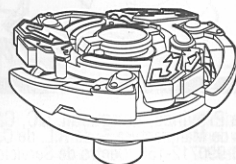

LAUNCH:

A

Choose which direction to launch your top (left or right spin) with the 2-Way Launcher. Insert ripcord as shown.

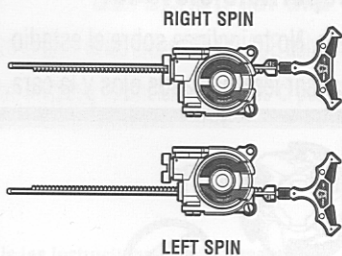

B

Insert Holder Lock tabs on launcher into grooves on Bit Protector. Launcher should stay attached to BEYBLADE®* top when inserted correctly.

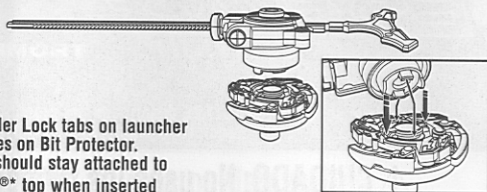

C

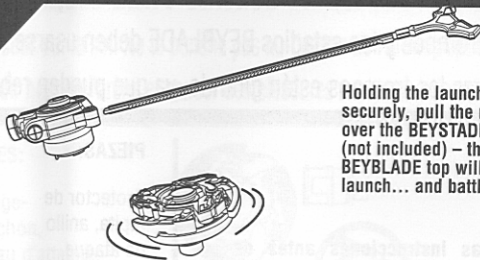

Holding the launcher securely, pull the ripcord over the BEYSTADIUM™ (not included) – the BEYBLADE top will spin... launch... and battle!

FEATURES:

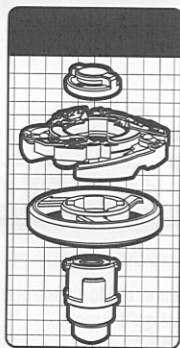

HARD METAL SYSTEM™* tops' steel components and low profile give it great attack strength, and make it a smaller target!

Most **HARD METAL SYSTEM™*** top parts are interchangeable with other **HARD METAL SYSTEM™*** tops!

WOLBORG MS™ has a free-spinning axel, giving it a long, stable spin!

CUSTOMIZE FOR EACH BATTLE!

WHAT IS CUSTOMIZING?

Customizing is taking parts from different BEYBLADE tops and putting them together to create a new top. Why customize? Because you can change how your top will perform in battle. By switching parts, you can create a top that will perform a certain way. For example, if your opponent has an Attack Type top, you may want to change your top's parts to make it a Defense Type top, to help withstand your opponent's attacks.

Learn all the different types of Attack Rings, Weight Disks and Spin Gears that are available and that you have in your collection. Look at the star chart on the packages to see the strengths of each top's parts and check out the website beyblade.hasbro.com for more information!

TRIPLE SHOT You and your opponent each battle 3 BEYBLADE tops for triple the action!

1



Get your 3 BEYBLADE tops ready.

2



Decide the play order of your BEYBLADE tops.

1

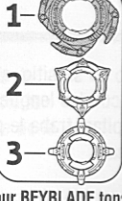

3

► Round 1
Round 2
Round 3

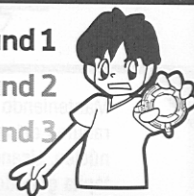

To start the game, players launch their first BEYBLADE top.

4

Play three rounds.

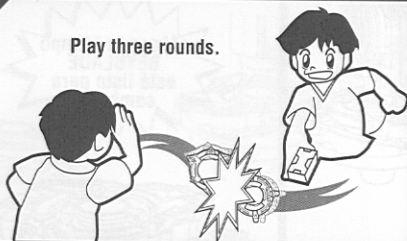

5

► Round 1
► Round 2
► Round 3



The player who wins two out of three rounds is the winner!

Check it out! For game ideas, strategies and official game rules, please see

www.beyblade.com
beyblade.hasbro.com



Product a
®* and/o
Manufact
© HUDSC
© Aoki Ta
TM & © /
MADE IN

