

Includes unassembled BEYBLADE top, launcher, and ripcord.  
Assembly required. No tools needed.

**⚠ WARNING: Do not use BEYBLADE tops or BEYSTADIUM™ on tables or other elevated surfaces.**

BEYBLADE tops/BEYSTADIUM are intended to be used on the floor. Do not lean over the stadium when BEYBLADE tops are in play. BEYBLADE tops may bounce up and hit eye or face.

- Before assembly and playing, please read instructions. Please keep these instructions for future reference.
- When removing parts from runner frame, ask an adult to help you trim off any excess plastic using scissors or other suitable tool.
- The frame is numbered. Please follow the numbers carefully and make sure you are assembling the right parts.
- Discard plastic bags immediately.

**PARTS:**  
Runner Frame Parts,  
Attack Ring, Launcher,  
Ripcord

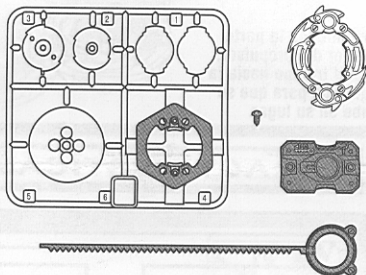

**BEYSTADIUM sold separately.**

## BUILD:

**1** Peel and apply labels as shown.

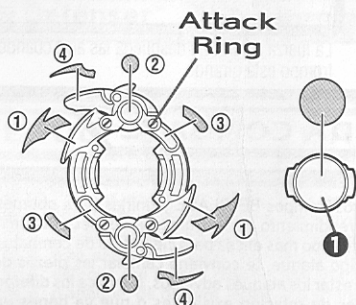

**2** Place top **2** on spin gear **3**, and attach spin gear assembly to Blade Base **5** with the screw, using a Phillips screwdriver (not included).

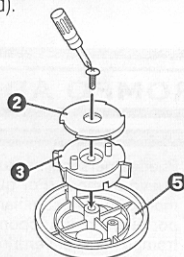

Note: Make sure screw is completely attached.

**3** Place Weight Disk **4** on Blade Base assembly.

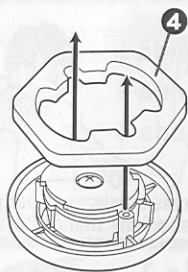

**4** Place Attack Ring onto Blade Base, aligning tabs on ring with grooves on spin gear. Turn ring **LEFT** until it locks onto base. To remove ring from base, turn ring right.

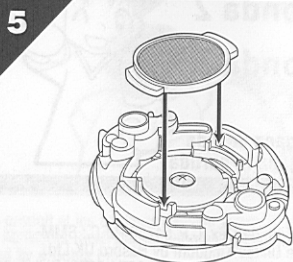
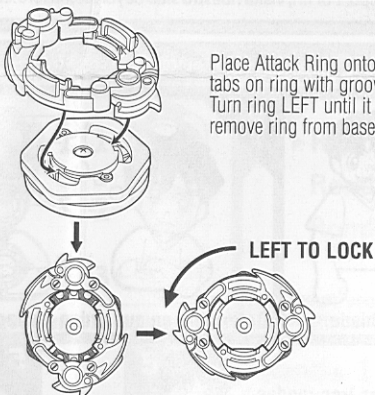

Place one Bit Chip on Attack Ring.

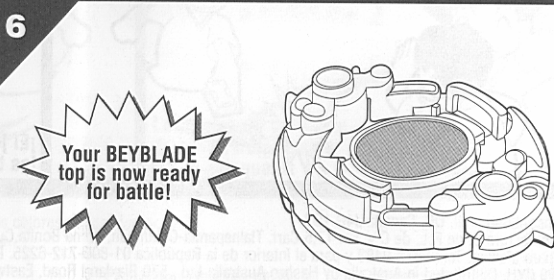

## LAUNCH:

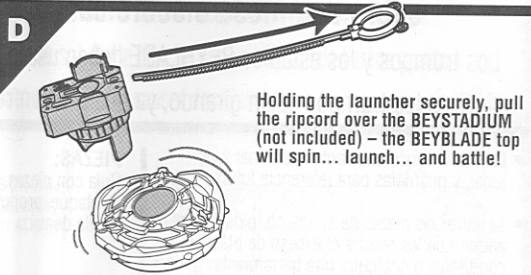
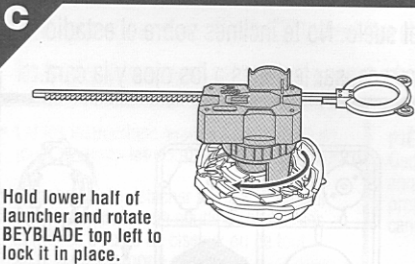
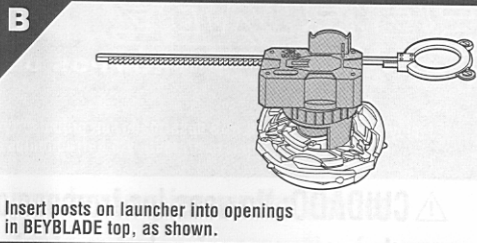
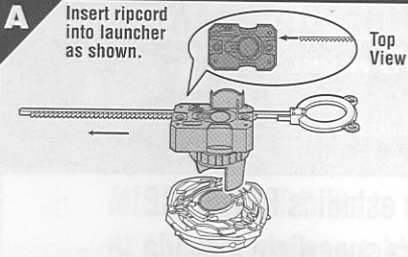

## FEATURES:

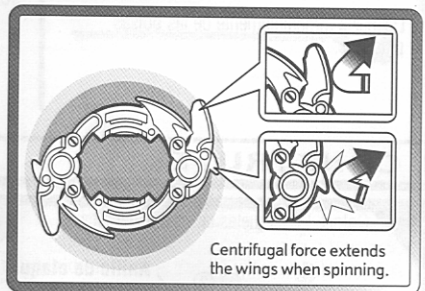
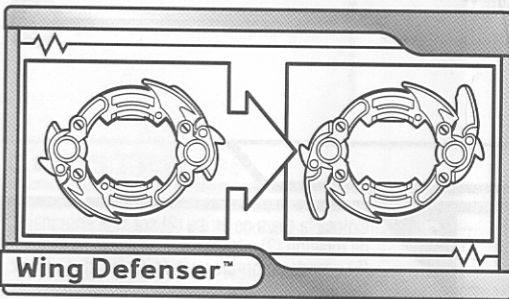

## CUSTOMIZE FOR EACH BATTLE!

### WHAT IS CUSTOMIZING?

Customizing is taking parts from different BEYBLADE tops and putting them together to create a new top. Why customize? Because you can change how your top will perform in battle. By switching parts, you can create a top that will perform a certain way. For example, if your opponent has an Attack Type top, you may want to change your top's parts to make it a Defense Type top, to help withstand your opponent's attacks.

Learn all the different types of Attack Rings, Weight Disks and Spin Gears that are available and that you have in your collection. Look at the star chart on the packages to see the strengths of each top's parts and check out the website [beyblade.hasbro.com](http://beyblade.hasbro.com) for more information!

**TRIPLE SHOT** You and your opponent each battle 3 BEYBLADE tops for triple the action!

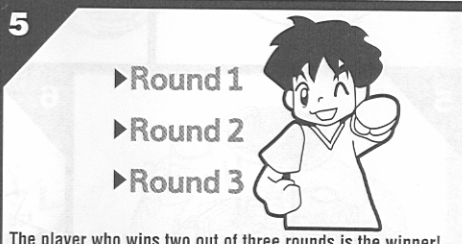
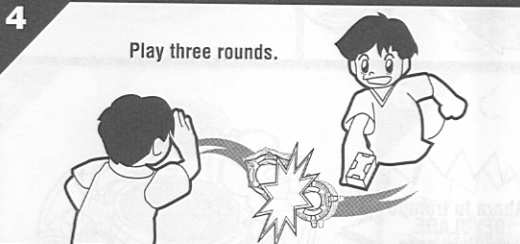
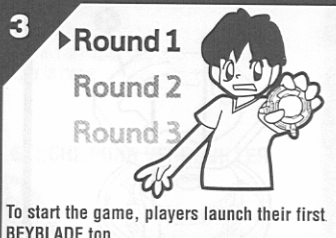
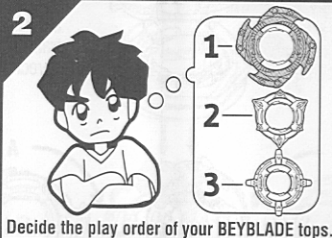

[www.beyblade.com](http://www.beyblade.com)  
[beyblade.hasbro.com](http://beyblade.hasbro.com)



Product and colors may vary and/or TM\* & © 2003 HUDSON SOFT/TAKARA © Aoki Takao • BB2Project • TM & © ABC Family World