

WARNING:
CHOKING HAZARD - Small parts.
Not for children under 3 years.

Ages 5 and up.

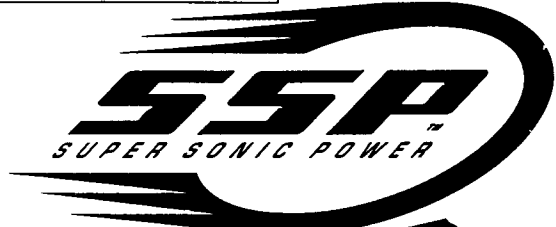

CRASH PIT™ PLAYSET

A FULL-FORCE COLLISION COURSE!

Instruction Sheet

1. Attach crash gate to ramp. Angle pins on ramp into hole on one side then push other side down.

crash gate
ramp

2. Attach left and right guard rails. Rails are marked left and right on inside of rail. Press top pin into hole then the others.

right guard rail
left guard rail

3. Attach the three rubber feet to bottom of ramp. Repeat steps 1, 2 & 3 for second ramp.

4. Attach crash wall halves together as shown.

5. Assemble exhaust pipes and canopy onto vehicle as shown.

canopy
exhaust pipe
exhaust pipe



6. How To Operate Vehicle:

A. Hold vehicle at the back, behind the wheel. Insert "T" handle Rip Stick™ into slot on either side of wheel until it stops... pull stick out quickly to rev up wheel. Caution: Never touch revved-up wheel with your hands or hold revved-up vehicle down on floor.

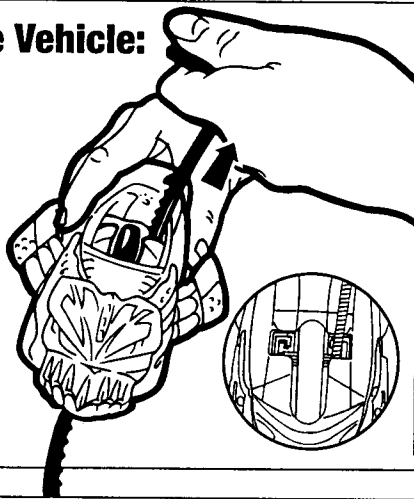

B. Immediately after revved-up, set the vehicle down with a slight push forward on a smooth, flat surface. The faster you pull the "T" handle Rip Stick™, the faster the vehicle will go.

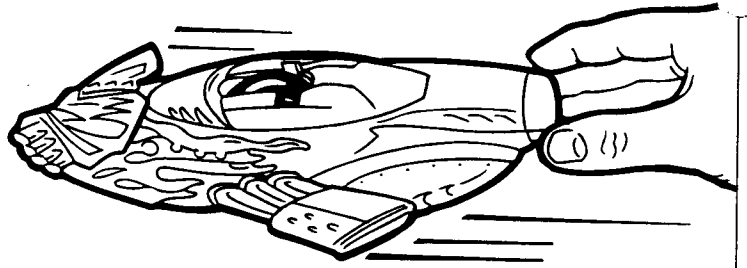

7. Crash Pit Stunts:

A. Into The Wall Of Pain™

With the crash gate down, set the wall in front of the ramp. Run vehicle over ramp into wall. Vehicle and wall come apart on impact!

Many action figures can attach to pegs on top of wall for added crash fun.

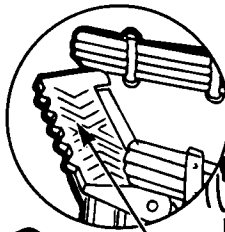

Gate down

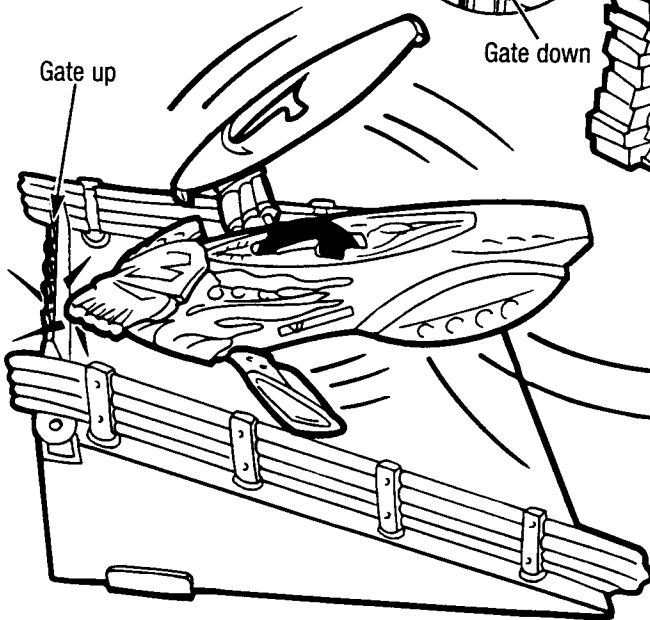

Gate up

B. Into The Crash Gate

With the crash gate up, run vehicle up ramp into crash gate. Vehicle will come apart on impact!

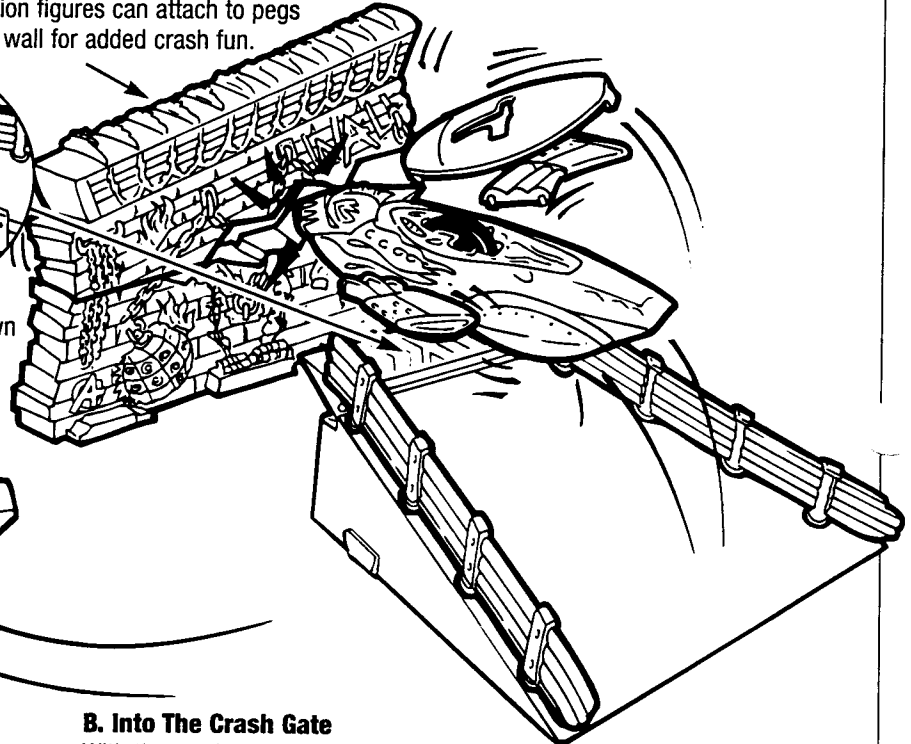

C. Jump The Ramps

Put both ramp crash gates down. Run vehicle over ramp to land on other ramp.

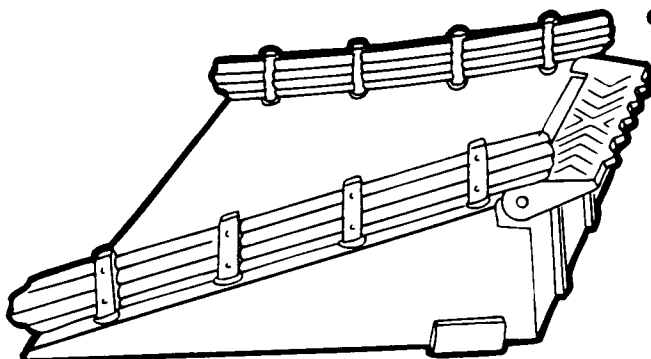

D. Head To Head

With practice you and a friend can take a second vehicle, sold separately, and have mid air collisions with your included vehicle. Run each vehicle up the ramps towards each other until you can make them collide for mid air fun.

