

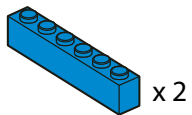

x 10

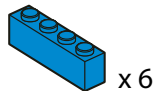

x 2



x 6

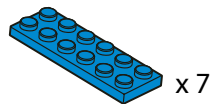

x 7

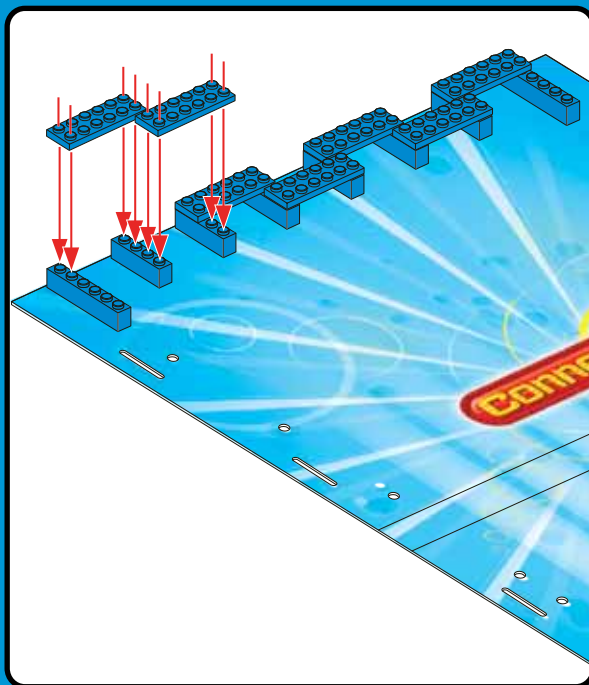
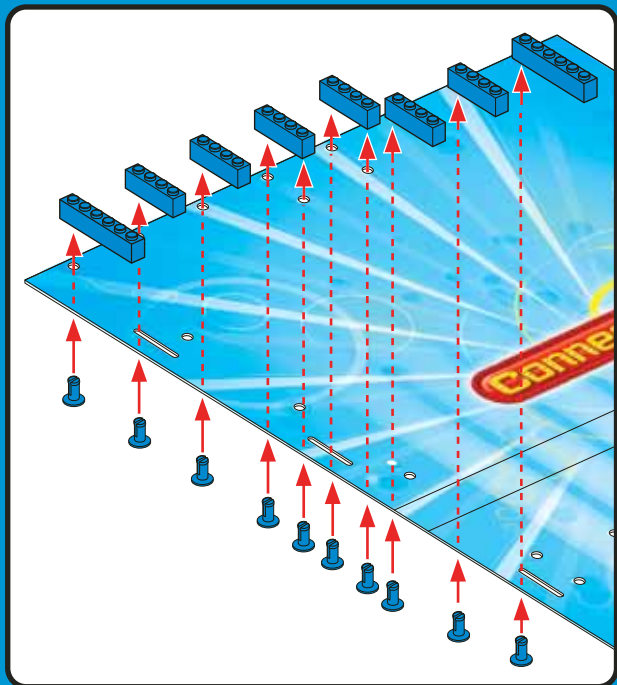

2

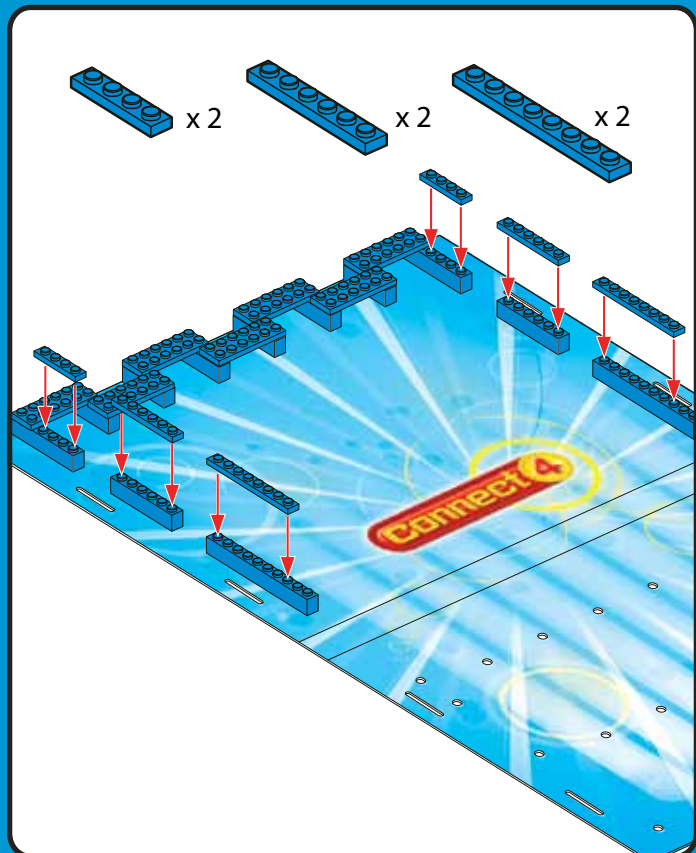
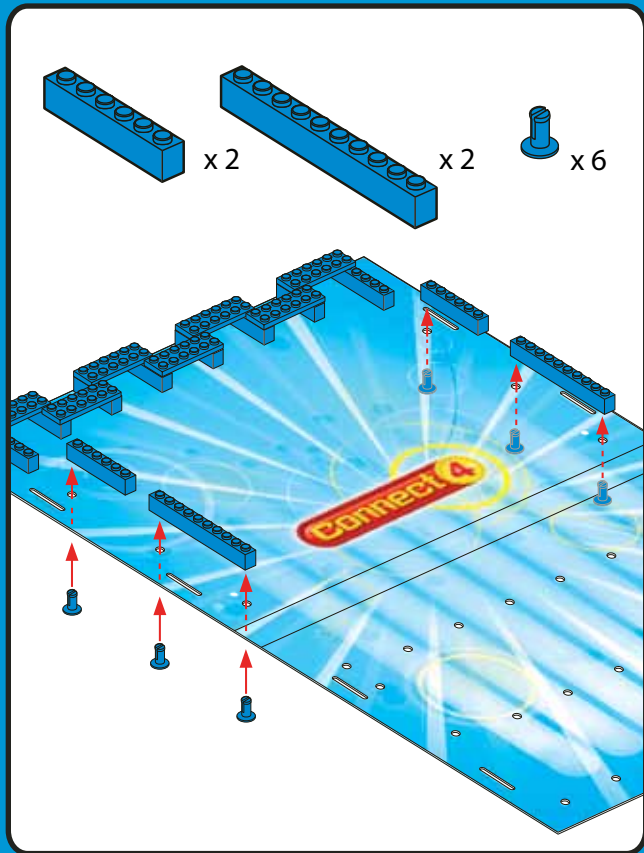

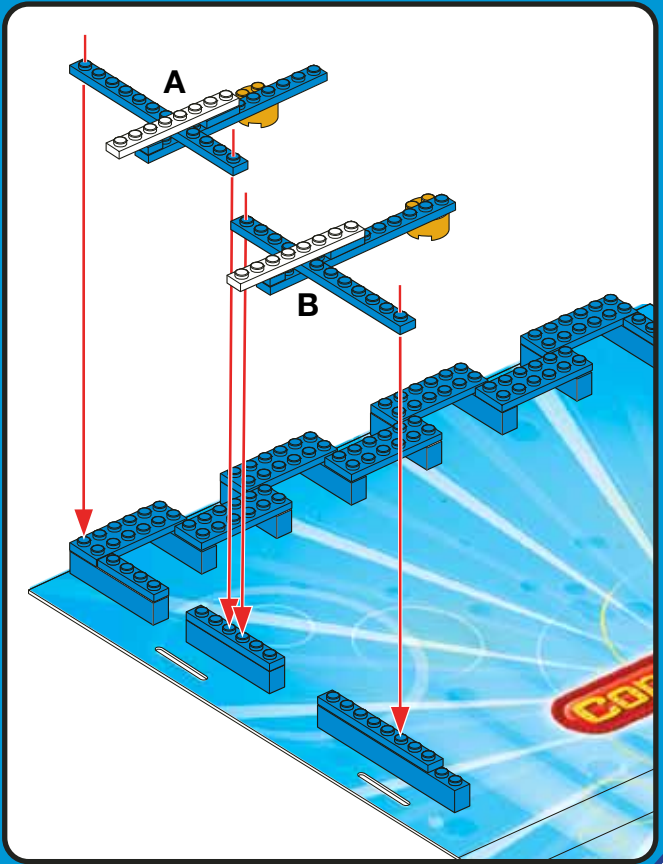
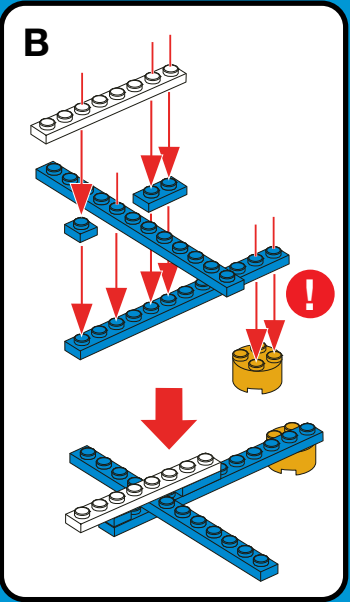
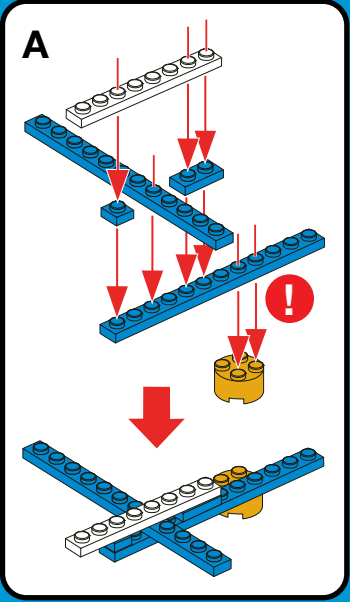
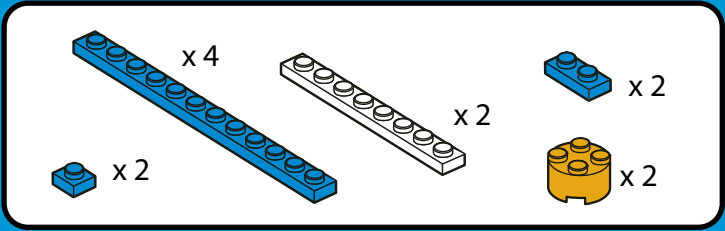

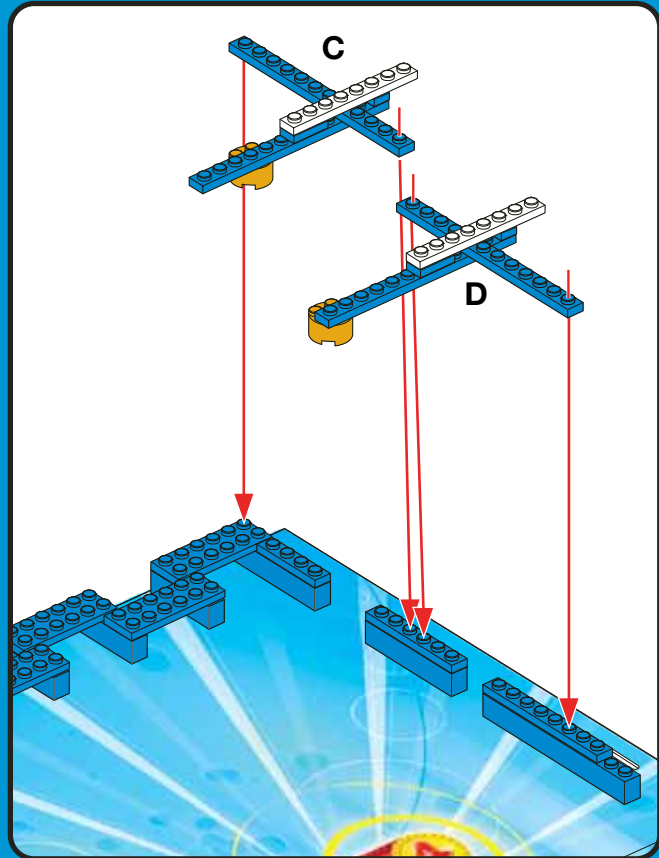
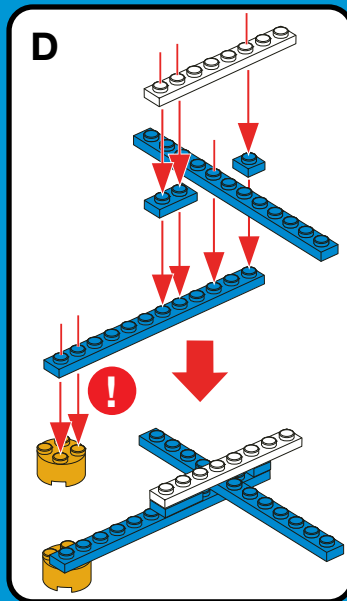
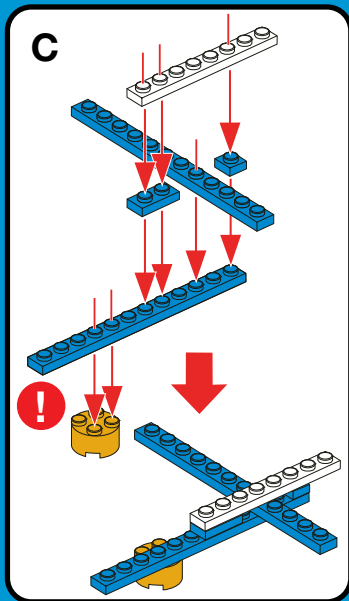
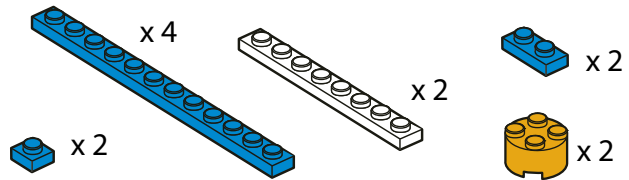

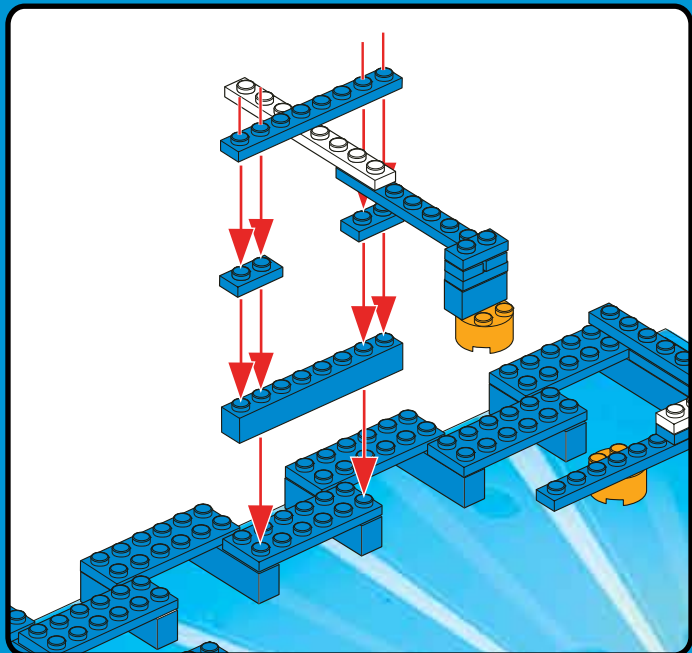
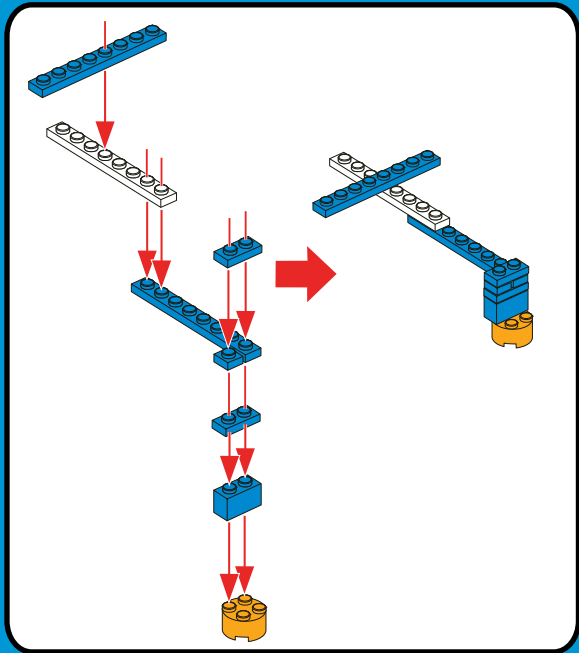
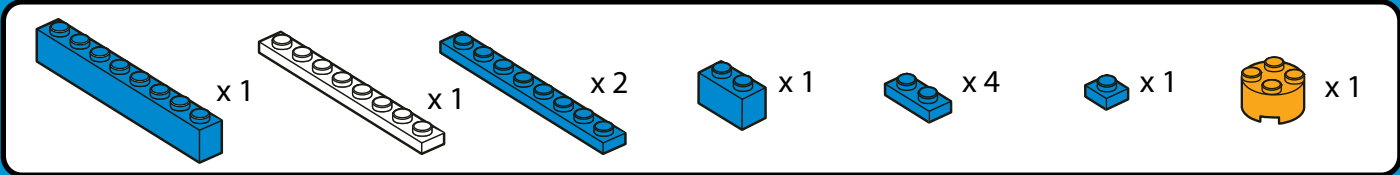



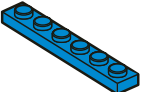
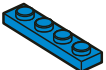

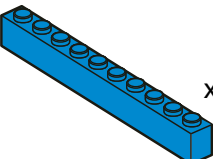
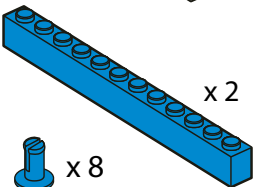
6

-  x 2
-  x 2
-  x 2
-  x 2
-  x 2
-  x 8

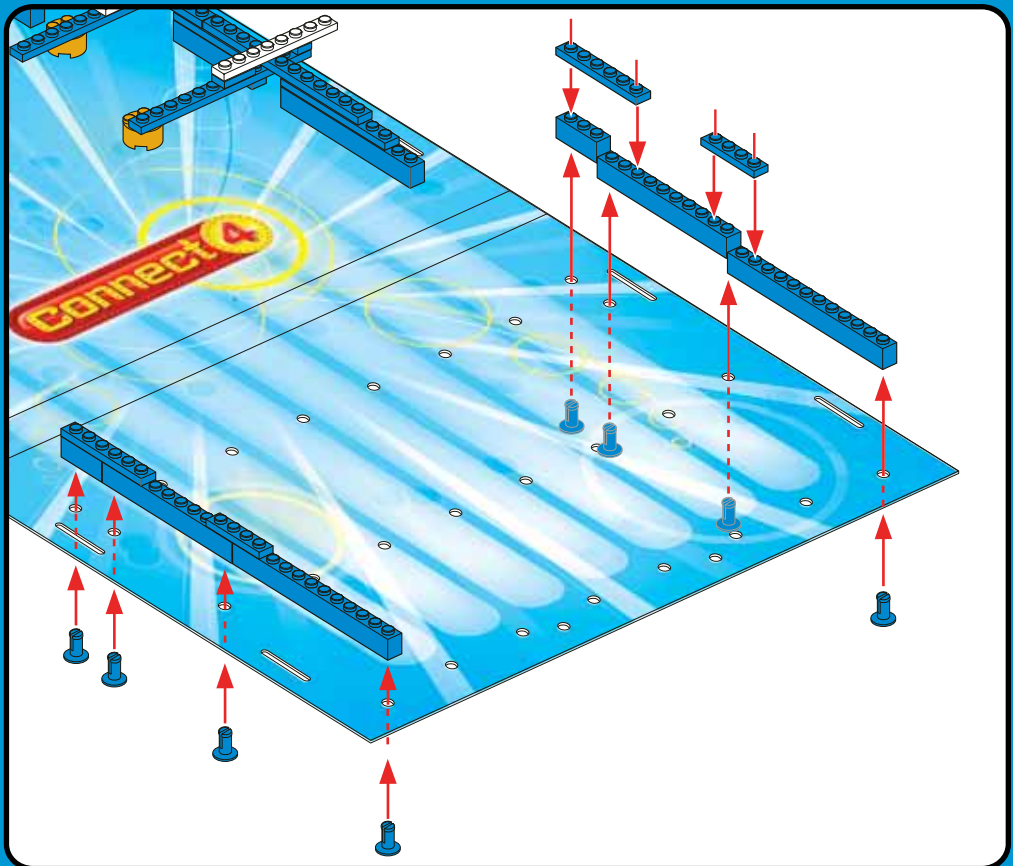



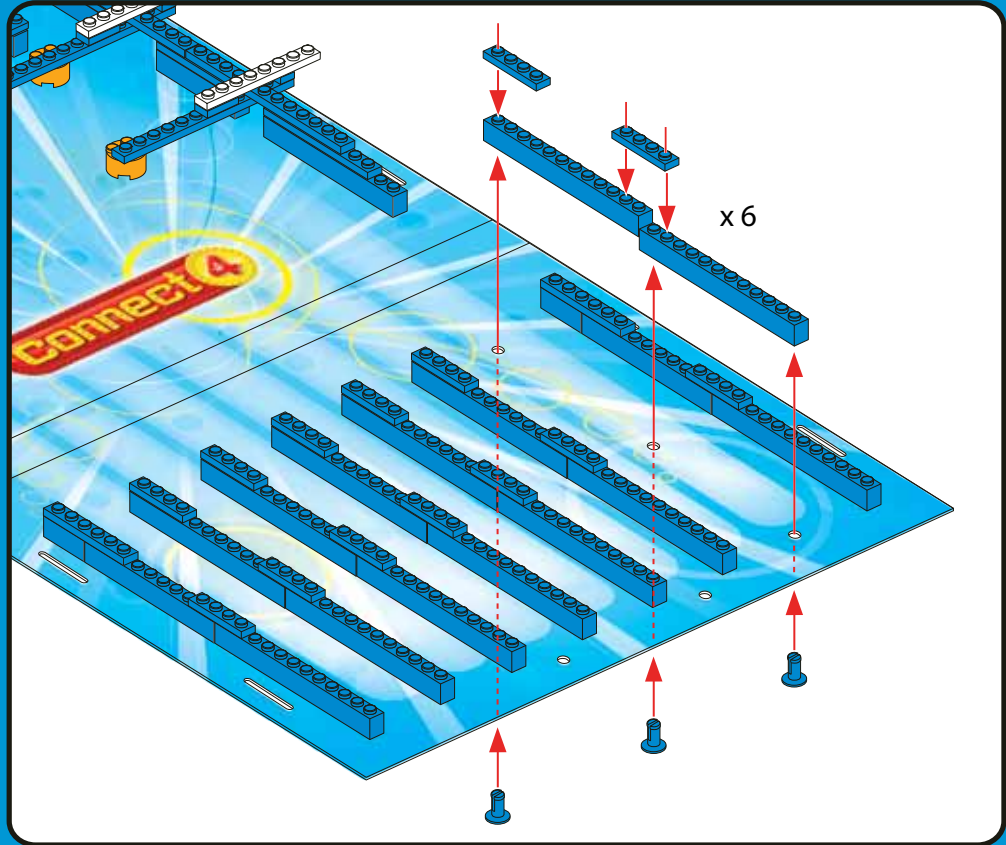
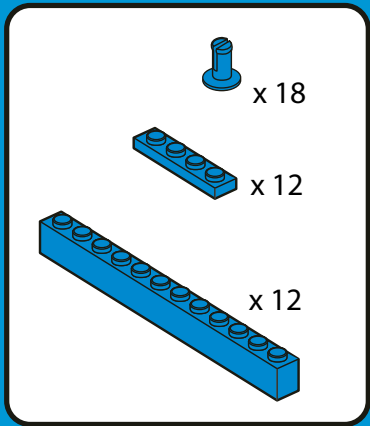

x 2



x 3

