

Fantastic Flowers®

COLOR SURPRISE™ FLOWER MAKING SET

Ages 5 & Up

Warning: Contains Small Parts Which Pose a Choke Hazard For Children Under the Age of Three.

Instructions

Attaching Labels to Flower Press

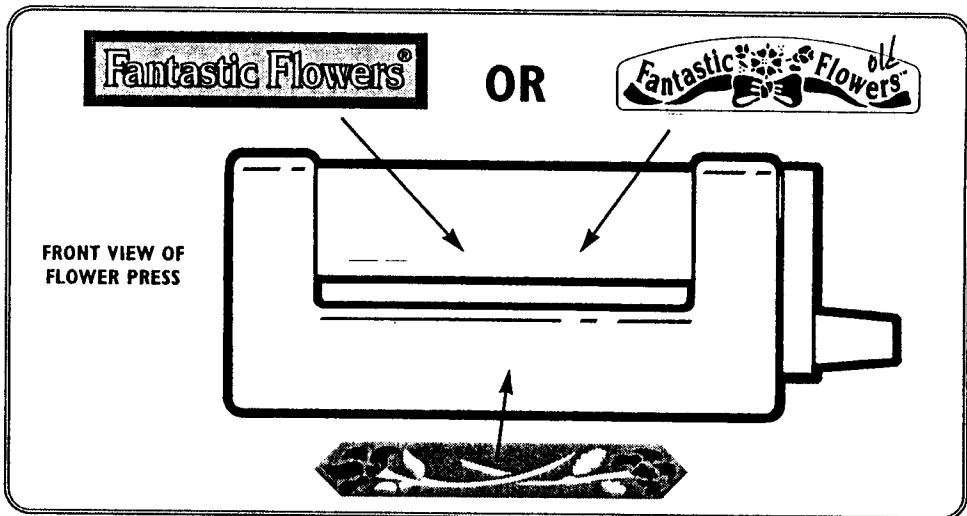

Peel and apply your labels as shown. This set comes with one or the other of the 2 Fantastic Flowers labels pictured above.

Please note: To remove parts from frame, simply twist off. After removing parts, use safety scissors to trim all excess plastic.

Assembling the Design Plates

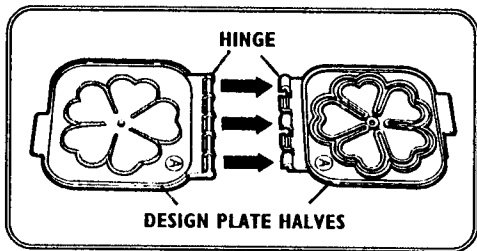

Remove both matching halves of a design plate from runner frame. Snap hinge together. Repeat for remaining design plates. Discard runner frames.

NOTE: Be sure to match top and bottom halves of plates before assembly. Match the two plates marked "A" into one pair (letter appears on inside corner of plate, beneath hinge), then repeat process to match "B" with "B", "C" with "C" and "D" with "D".

Attaching the Rubber Feet

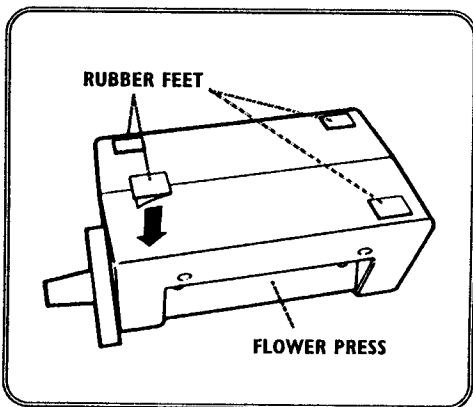

Peel backing off rubber feet, and only feet to bottom of flower press as shown.

Making a Flower

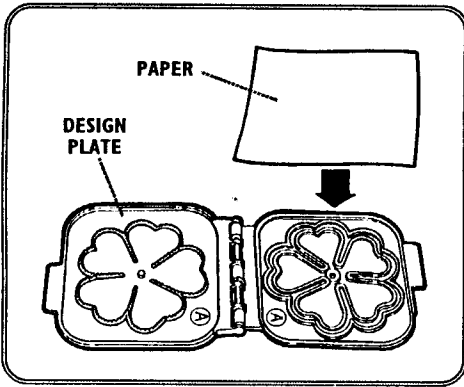

1 Choose a design plate. Place a piece of paper inside. Close the plate.

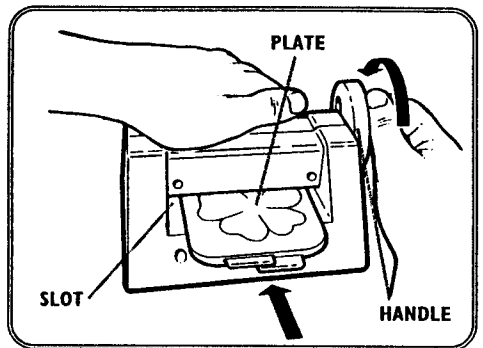

2 Insert the plate, as shown, into the slot in the flower press. Turn the handle until the plate comes out the other side. You may have to push the plate in to get it started.

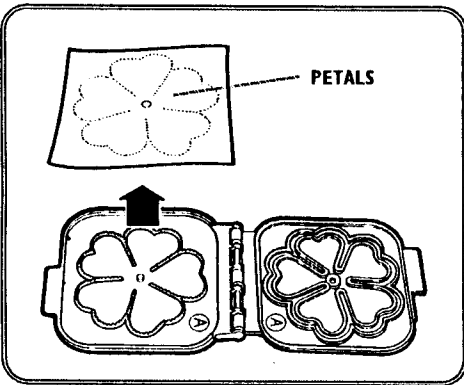

3 Remove the paper from the plate, and take out the petals.

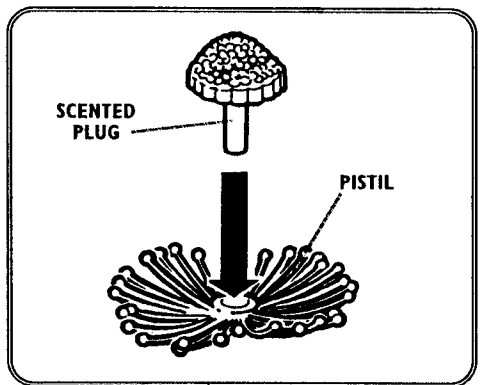

4 Fit a pistil onto a scented plug.

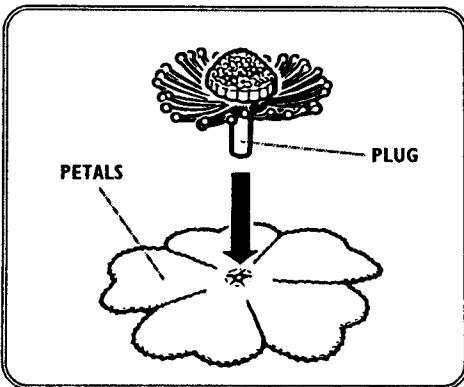

5 Place petals onto the plug.

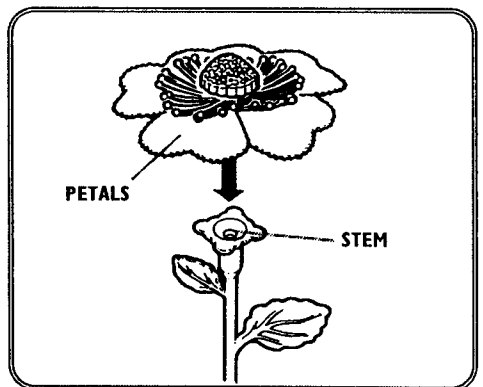

6 Fit the plug into the center of the stem.

Color Surprise Spray Bottle:

For your Fantastic Flowers to magically change color, you must place 2 of the paper strip inserts into the spray bottle (Ill. 1), and then fill bottle to the top with water (Ill. 2). Please note that this set includes 4 paper strips, which are used 2 at a time. You will have 2 strips left for future use. After filling, screw top piece onto bottle (Ill. 3).

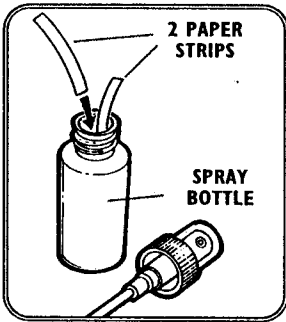

Illustration 1

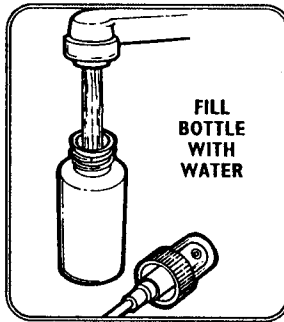

Illustration 2

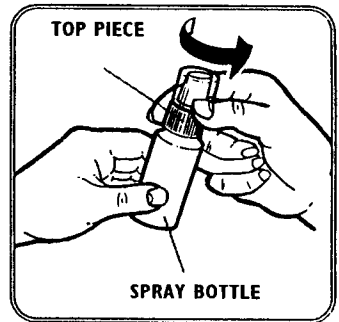

Illustration 3

Please note that there are two requirements for the Color Surprise feature to work properly: you must place 2 of the strip inserts into the bottle, and you must use only Color Surprise paper with the spray bottle to make the flowers.

2

Spray a mist of water from the bottle onto your completed flowers and the flowers will magically change color!

(Note: you may hold the spray bottle up to 8 inches from the flower.) You can mist the entire flower or choose spots to create beautiful patterns of pretty colors!

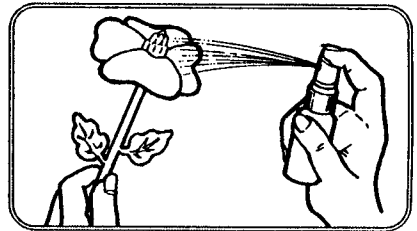

Flower-Making Ideas

Use one to 4 pieces of paper to make petals. Combine different colors and different shapes to create lots of pretty bouquets. Use the end of a stem to curl the petals up or down for a different look.

NOTE: YOU CAN ALSO USE YOUR OWN ARTS AND CRAFTS ACCESSORIES TO CREATE DIFFERENT FLOWERS, VASES, JEWELRY AND MORE!

Making a Vase

Cover a can with a large piece of paper, aluminum foil, wrapping paper or construction paper to make a vase to display your flower creations. Cover the can with the paper, and trim the paper to fit the size of the can. Glue or tape the ends of paper together.

Make your vase even fancier by gluing glitter to the paper, coloring in designs with markers or paint, or creating imaginative looks with yarn or uncooked macaroni. Look around your house for more things you can use to decorate your vase.

Design vases for special occasions -- pastel paper with lacy trim for a wedding bouquet, or brightly colored paper and ribbons for a party bouquet.

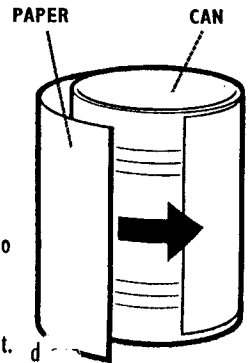

More Creative Ideas

You and your friends can make flowers and give them to each other as "friendship flowers."

Fantastic Flowers® are perfect for parties. Use them as favors for your guests, colorful decorations, or invitations -- just attach the petals to the card.

Make your own picture frame for your friends. Cut out a frame for the picture and attach the petals to the frame.

Make a necklace or a bracelet. Run yarn or string through petals and tie the ends together.

Decorate barrettes, hair clips and hairbands. Attach petals to hair accessories with glue for a colorful new look.

Add petals to your outfits -- pin them on shirts, fit them over buttons, string them onto shoelaces.

NOTE: Cans, glitter, markers, paint, yarn, macaroni, string, glue, cards, picture frame, hair accessories, clothes, pins, buttons and shoelaces not included.

Additional Ideas/Substitutes

There are many household items that may also be used as parts for Fantastic Flowers.

Stems:

Drinking straws, either regular or bendable, may be used for stems. Attach the stems to petals using a paper clip or fastener, shoe lace or cord.

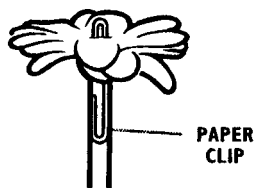
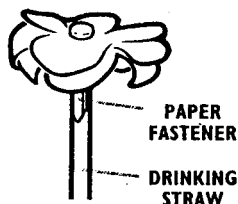

Plugs:

Paper fasteners or clasps may be used for plugs. Run fastener through the top of the petals then slide it onto the straw/stem. Secure it in place by bending the clasp slightly before attaching it to the stem.

Open a paper clip into an "S" shape, attach the top half to finished petals, then slide the clip into the straw.

String a shoe lace or cord through the top of the petals, run the lace (or cord) through the straw/stem, then tie a top and bottom knot to secure it in place. The top knot is now the plug!

Cotton balls or kitchen foil may be used as decorative touches to the plugs. Attach them to the top or bottom center of the petals.

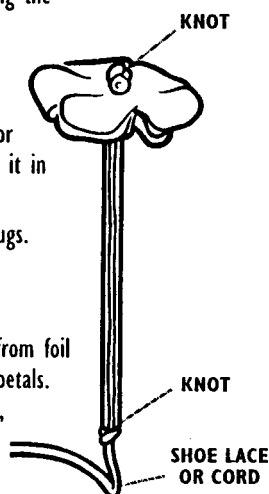

Petals:

Many different kinds of paper may be used for making petals. Anything from foil to wrapping paper to the Sunday comics will make great-looking flower petals.

You can also decorate plain white or construction paper with watercolors, finger paints, markers, crayons or confetti for pretty and creative combinations.

NONTOXIC CONFORMS TO ASTM D-4236-89

© 1994 Hasbro, Inc., Pawtucket, RI 02862 U.S.A. All Rights Reserved.

® denotes Reg. U.S. Pat. and TM Office. Flower pistils made in China.

All other parts made S.A.

R483 P/N 4516120

HASBRO TOY
A DIVISION OF HASBRO, INC.