

Ages: 4 & Up

# HOT STYLES™ FASHION Plates®

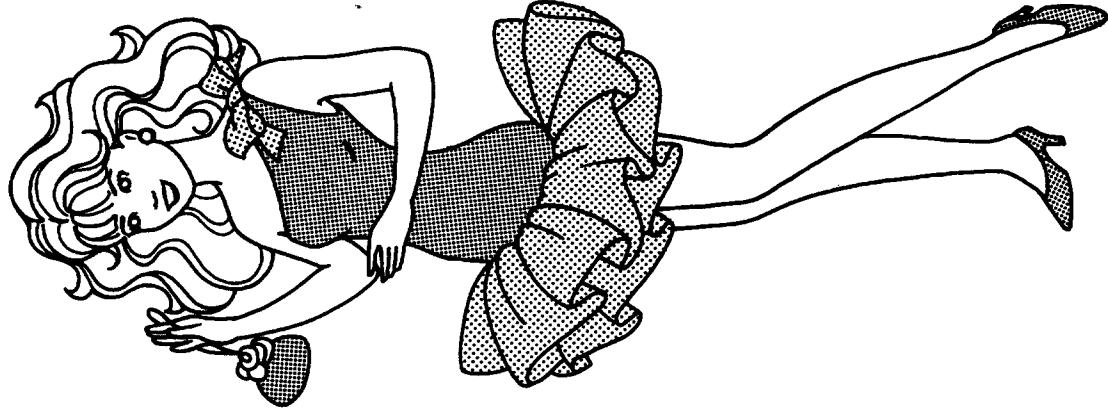

2508



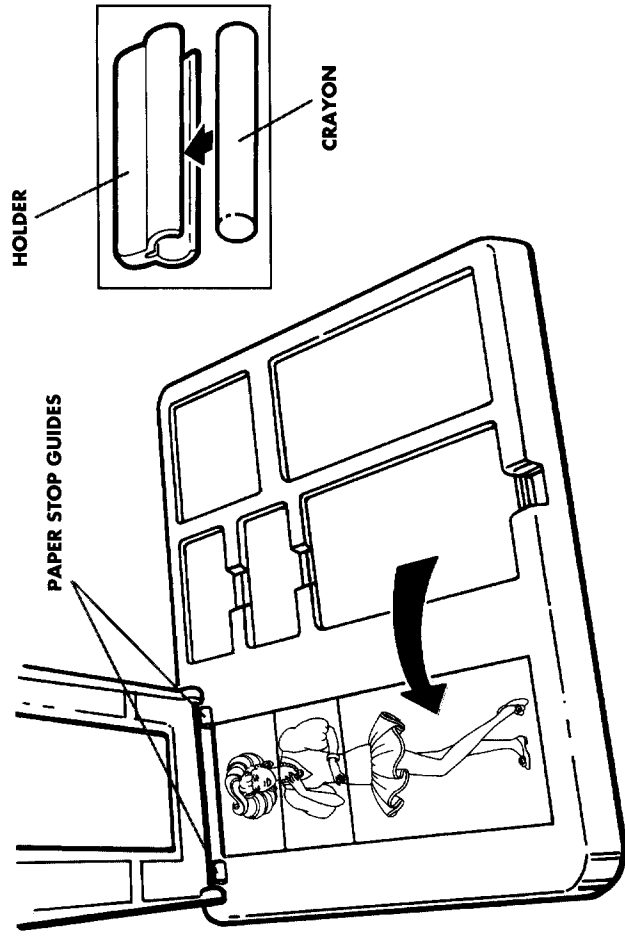

**1** Choose plates to create a fashion design and place them in tray as shown. Snap the scented crayon securely into crayon holder (inset).

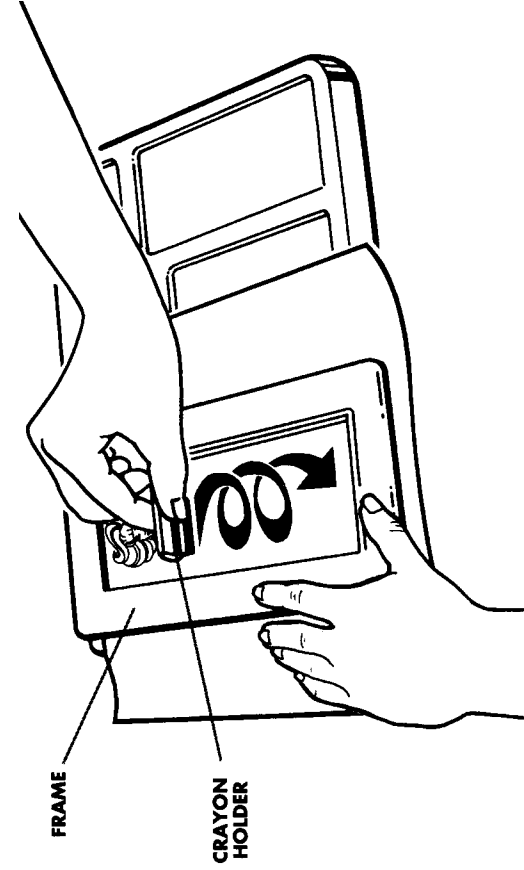

**2** Place a sheet of paper under the frame firmly against paper stop guides. Rub the crayon holder softly across the paper in a circular motion.  
**FOR THE BEST PICTURES, HOLD FRAME DOWN AND KEEP CRAYON LEVEL.** The frame should also be periodically cleaned.

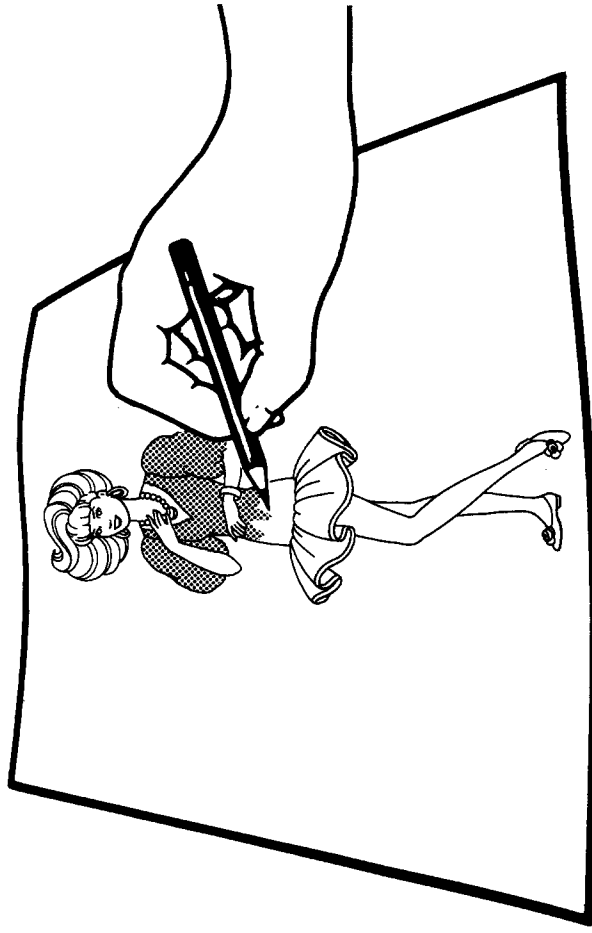

**3** Remove and place paper on a flat surface, and use the colored pencils to color in your hot new style.

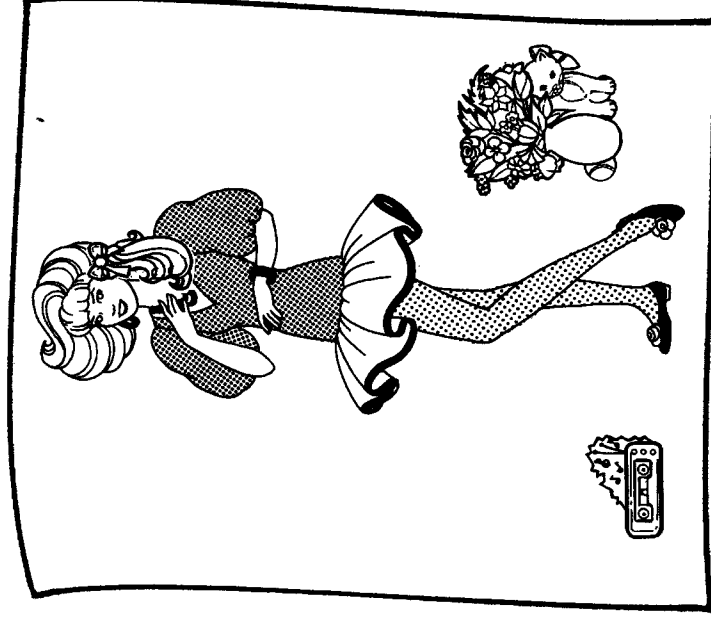

**4** Add the colorful accessory stickers to complete your design!

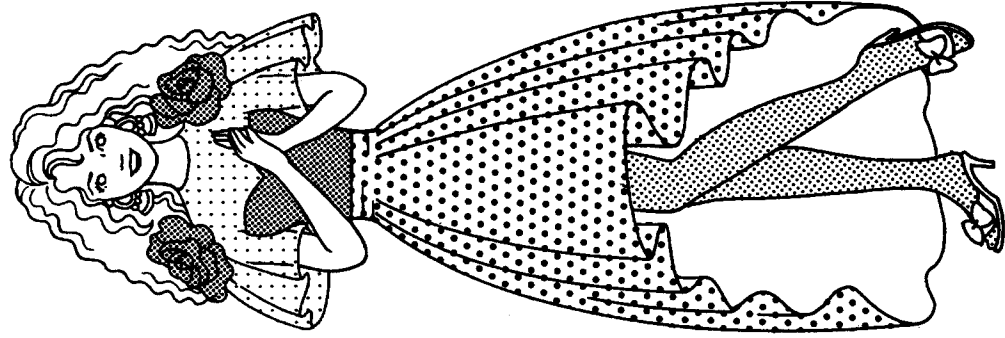
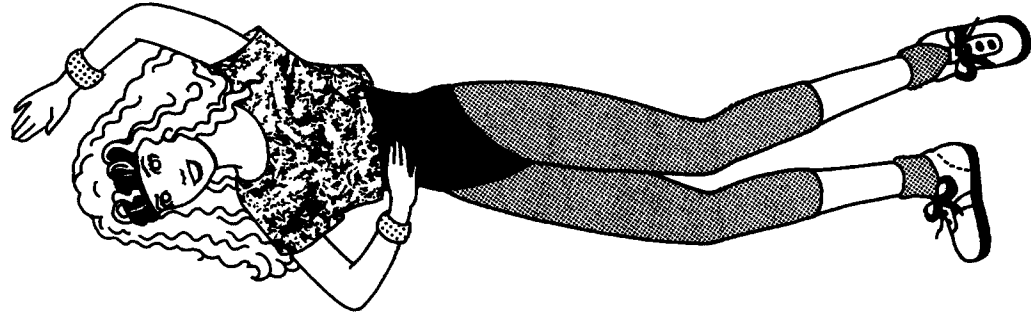

**Mix and match plates to create the hottest new fashion designs. Be creative with colors - use one color or combine different ones. Have fun!**