

## U.S. FLAG AIRCRAFT CARRIER INSTRUCTIONS

### IMPORTANT:

- 1 Familiarize yourself with all aircraft carrier parts before beginning assembly.
- 2 Do not detach parts from runner frames until needed. (Safety scissors may be necessary).
- 3 Peel and apply labels on all sections of aircraft carrier excluding the deck. See label placement instructions.

SOME ADULT ASSEMBLY MAY BE REQUIRED.

### BOW & STERN SUBASSEMBLIES

BOW — Front  
STERN — Rear  
PORT — Left Side  
STARBOARD — Right Side

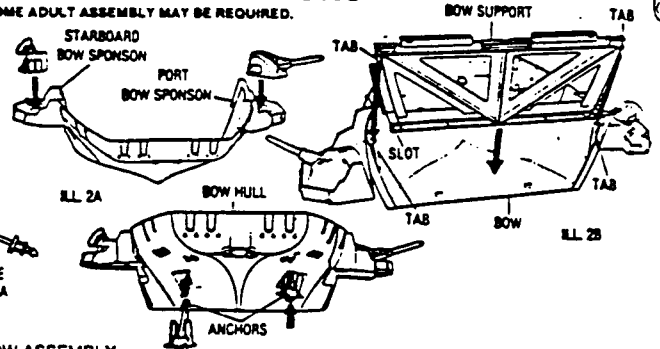
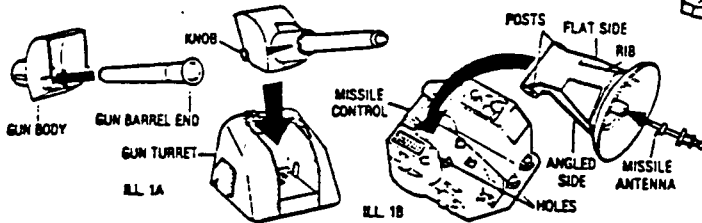

### BOW & STERN NAVAL GUNS, MISSILE CONTROL RADARS

- 1 A. Insert end of gun barrel into hole in gun body. With barrel facing front, slide gun body into gun turret and snap knobs into place. Repeat with 2 remaining guns.  
B. With rib facing up, insert post on angled side of dish into hole in missile control. Snap post on flat side into position. Insert missile antenna into hole in radar dish. Repeat with remaining missile control radar.

### BOW ASSEMBLY

- 2 A. Guide tabs on missile control into hole in starboard (right) bow sponson. Guide tabs on gun turret into hole in port (left) bow sponson. HINT: Check from under sponsons to make sure tabs are guided correctly, then snap tabs firmly into position. Insert anchors into holes in bow hull, as shown.  
B. With slot facing out, slide tabs on bow support (marked "BOW") over tabs in bow as shown.

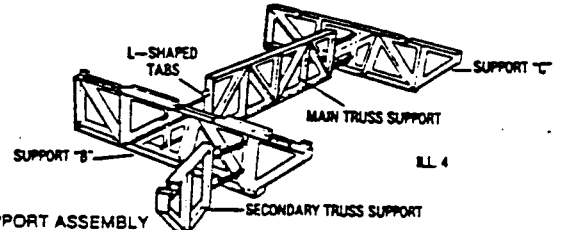
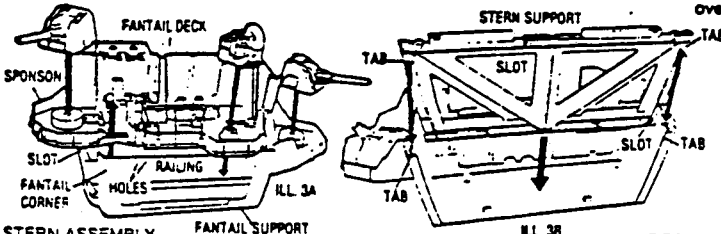

### STERN ASSEMBLY

- 3 A. Guide tabs on gun turret into fantail deck sponson. Guide tabs on missile control into hole in fantail deck. Guide remaining gun turret into fantail support sponson. HINT: Check from under sponsons to make sure tabs are guided correctly, then snap tabs firmly into position. Slide slot in fantail deck over corner of fantail support.  
B. With slot facing out, slide tabs on stern support over tabs in stern as shown.

### DECK SUPPORT ASSEMBLY

- 4 With L-shaped tabs facing down, insert tabs on main truss support into slots in truss supports "B" and "C", as shown. NOTE: Truss supports are marked "B" and "C". Locate secondary truss support. With L-shaped tabs facing down, insert tabs on secondary truss support into slots in support "B", as shown.

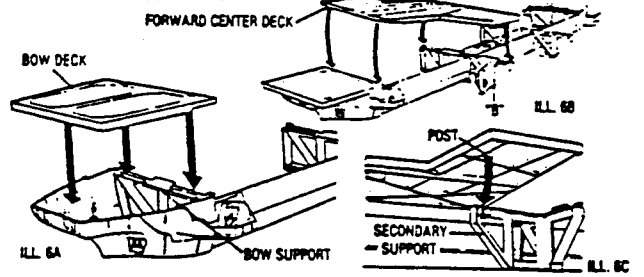
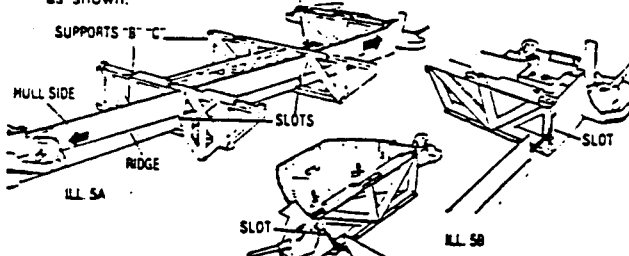

- 5 A. With ridge facing out and wide section on top, insert hull side through slots in supports "B" and "C" as shown.  
B. Insert ends of hull side into slots in bow and stern supports.

- 6 A. Line up holes in bow deck with holes in bow support.  
B. Line up holes in forward center deck with holes in support "B" and in bow support as shown.  
C. Insert post on secondary support into hole underneath forward center deck.

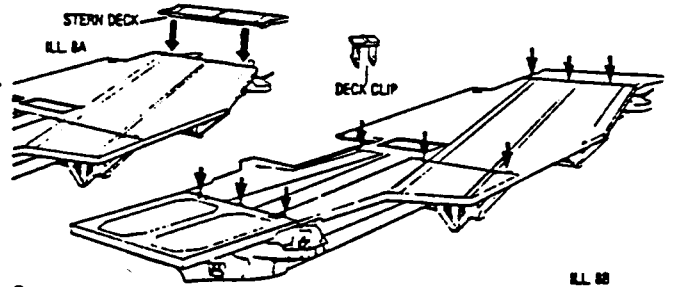
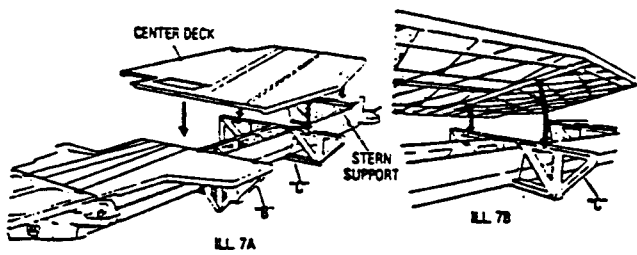

- 7 A. Line up holes in center deck with holes in support "B" and stern support.  
B. Make sure posts on support "C" are inserted into holes underneath center deck.

- 8 A. Line up holes in stern deck with holes in stern support.  
B. Insert deck clips into holes in bow, forward center, center, and stern decks as shown.  
C. Apply deck labels.

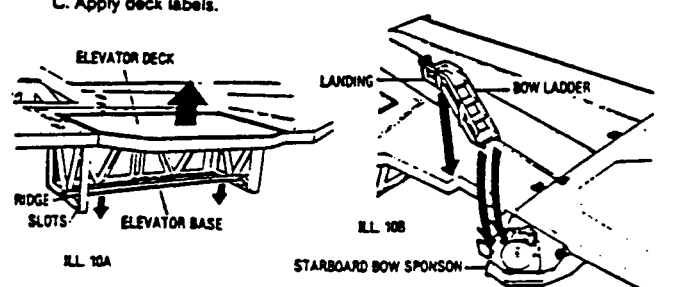
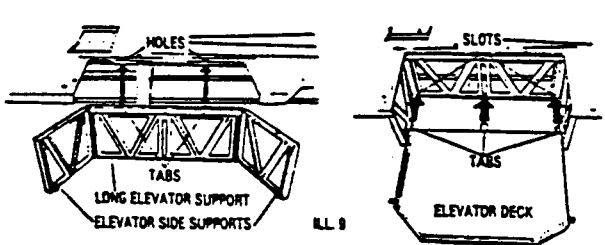

- 9 Insert L-shaped tabs (facing down) on elevator side supports into slots in long support. Insert tabs on elevator supports into deck holes as shown. Insert tabs on elevator deck into slots in elevator support. Elevator slides up and down for realistic play.

- 10 A. Press ridge on elevator base into slots at bottom of side supports. NOTE: Slide elevator deck down before continuing instructions.  
B. Insert tabs on bow ladder into holes in starboard bow sponson. Rest landing on deck as shown.

6001

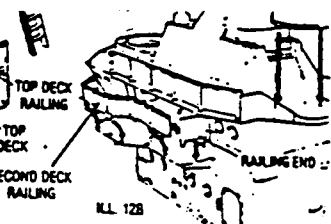
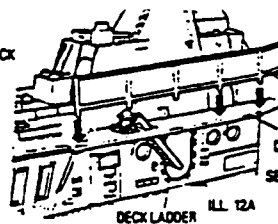
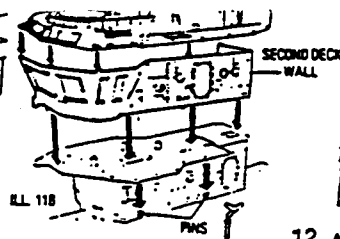
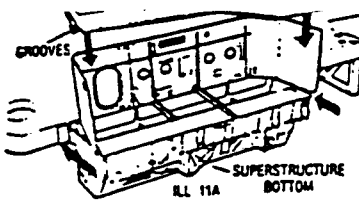

- 11** A. Slide superstructure bottom onto deck, as shown. Line up grooves and place second deck onto superstructure bottom.  
 B. Insert superstructure pins into holes to secure superstructure. Place second deck wall onto second deck and snap tabs into place. Place superstructure top onto second deck wall and snap tabs into place.

- 12** A. On outside of superstructure, slide slots on deck ladder over ledge of ladder opening. Insert tabs on top deck railing into holes in top deck.  
 B. Insert tabs on radome into holes in superstructure top. Insert tabs on railing end into holes in second deck, as shown. Insert side tab of second deck railing into slot in railing end. Fit railing tabs into deck.

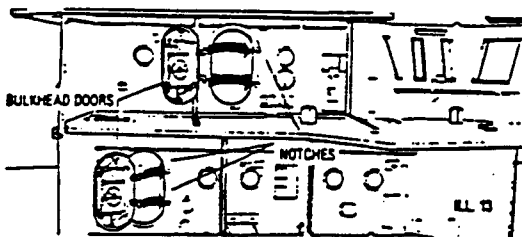

**SUPERSTRUCTURE SUBASSEMBLIES**

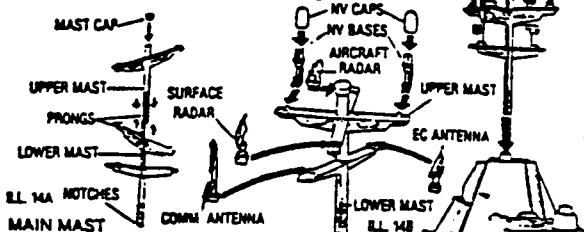

- 13** A. Insert posts on bulkhead doors into notches near bulkhead door openings.

- 14** A. Slide prongs on upper mast through prongs on lower mast. Fit ends of upper prongs into notches at base of mast. Fit mast cap over top of mast.  
 B. Fit navigational system (NV) caps over NV Bases. Slide notches on surface radar, aircraft radar and NV bases onto tabs on upper mast. Repeat with communications antenna and electronic countermeasure (EC) antenna onto tabs on lower mast. Insert mast bottom into hole in superstructure top.

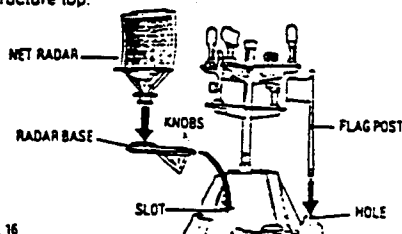
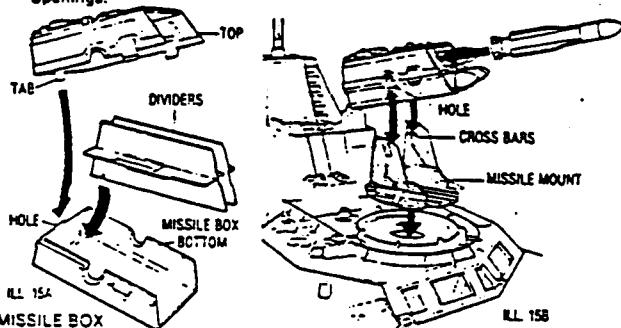

- 15** A. Place missile dividers into missile box bottom. Insert tab on missile box top into hole in missile box bottom. Snap front tabs into place.  
 B. Fit holes on sides of missile box over cross bars on missile mount, as shown. Insert 6 missiles into missile box. Insert missile mount into hole on top deck of superstructure.

**AIR SEARCH NET RADAR AND FLAG POST**

- 16** Snap net radar into radar base. Insert knobs on base into slot in superstructure top. Insert flag post into hole on top of superstructure.

**DECK SUB-ASSEMBLIES**

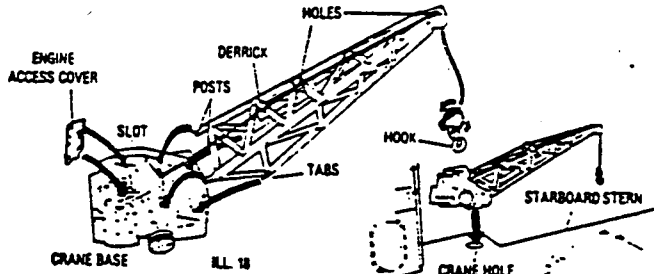
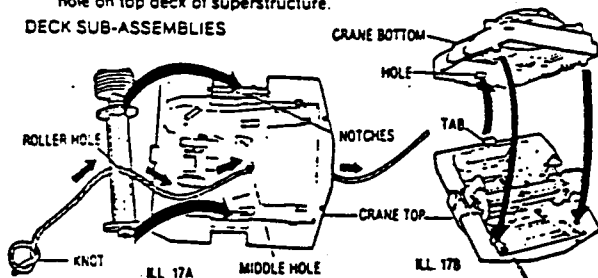

- 17** A. Thread string through hole in roller and tie knot. Insert other end of string through middle hole underneath crane top. Place roller on 2 notches in crane top.  
 B. Insert tab on crane top into hole in crane bottom. Snap crane top and bottom together.

- 18** Hook 2 posts on derrick into 2 top holes in crane base. Snap bottom tabs into place. Feed string through slot and hole on derrick. Tie crane hook onto end of string. Snap engine access cover over crane engine. Insert crane base into crane hole in deck.

**BOAT & AIRCRAFT CRANE**

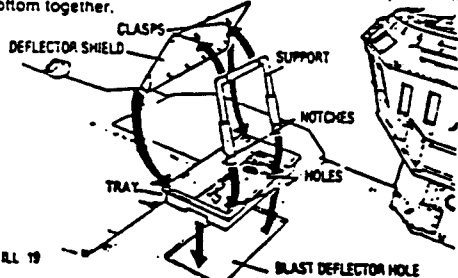

- 19** Snap knobs on deflector shield into holes on sides of deflector tray. Snap deflector support onto clamps under cover. Hook notches on bottom of support into holes in floor of tray. Fit tray into blast deflector hole in deck.

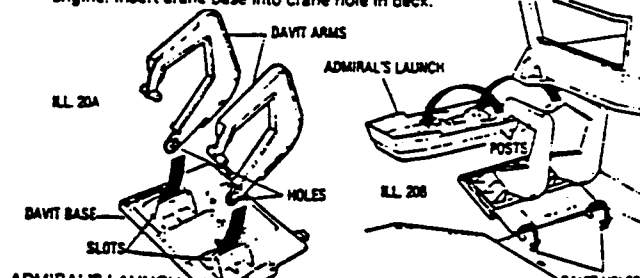

- 20** A. Insert holes in davit arms between slots on davit base, as shown. Snap into place.  
 B. Insert tabs on davit base into davit holes on deck. Insert posts on davit arms into holes in launch.

**ARRESTOR HOOK**

- 21** A. Insert string up through hole A in one arrestor base. Tie knot at end of string underneath base. Thread other end of string down through hole B, then up through hole C.  
 B. With other arrestor base, insert end of string down through hole C, then up through hole B, and finally down through hole A. Tie knot at end of string underneath base. Insert tabs on bases into arrestor holes.

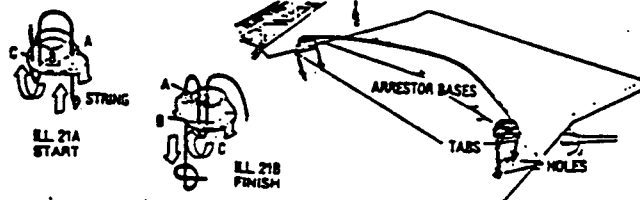

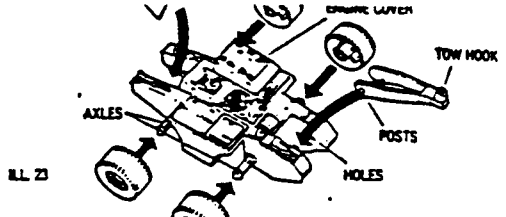
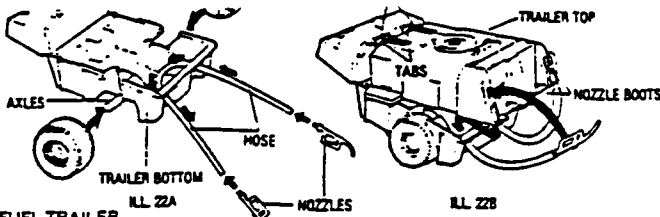

**FUEL TRAILER**

- 22 A Insert nose through one hole and out the other in trailer bottom, as shown. Insert 2 fuel nozzles into ends of hose. Snap 2 wheels over trailer axles.  
 B Snap tabs on trailer top into holes in trailer bottom. Snap trailer top and bottom together. Hook fuel nozzles onto nozzle boots on back of trailer.

**TOW VEHICLE**

- 23 Snap 4 wheels over tow vehicle axles. Slide tow vehicle seat into vehicle, as shown. Fit engine cover over engine. With tow hook facing up, insert posts into holes in back of vehicle. Tow vehicle hauls fuel trailer and other G.I. Joe vehicles onto the runway.

**SUPERSTRUCTURE ASSEMBLY**

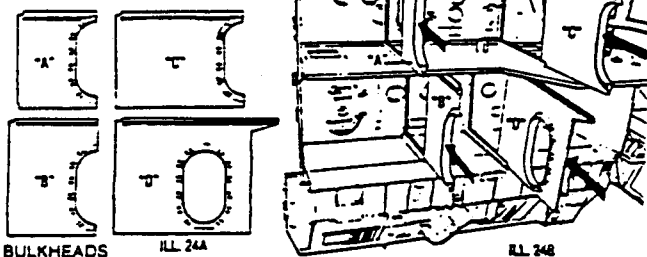

**BULKHEADS**

- 24 A Identify bulkhead walls.  
 B Slide bulkhead walls into slots on superstructure decks as shown.

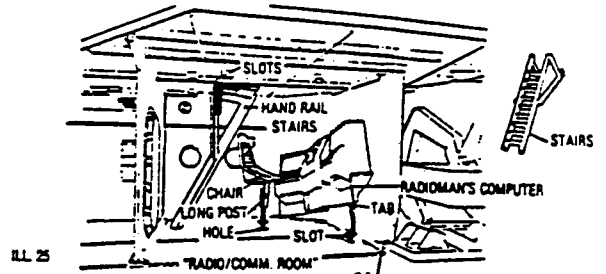

**RADIO/COMMUNICATIONS ROOM (lower right deck)**

- 25 Insert tab on left side of radioman's computer into slot in wall. Place tab on computer into slot in deck. Insert long post on radioman's chair into hole in deck. Insert tabs on hand rail stairs into slots underneath upper deck and slide into place.

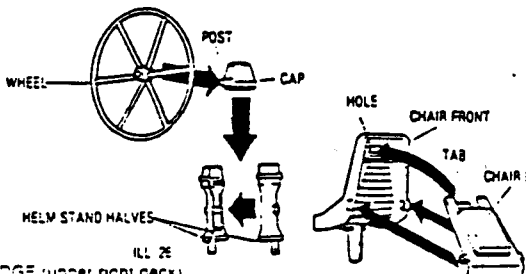

**BRIDGE (upper right deck)**

- 26 Apply bridge labels (Refer to Label Placement Instructions.) Insert tab on chair back into hole in chair front. Snap bottom of chair together. Snap left and right helm stand together. Fit helm cap onto helm stand. Snap helm wheel over post on helm cap.

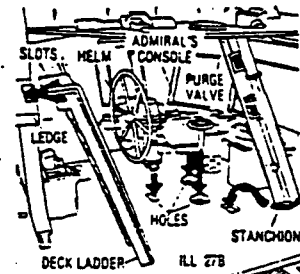
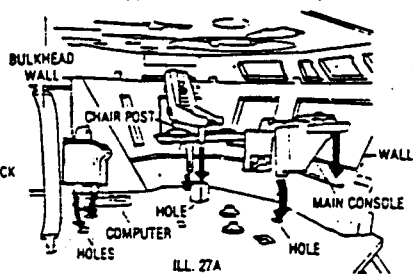

- 27 A. Insert posts on main console into holes near window wall. Insert Admiral's chair post into chair hole on bridge deck. Insert 2 posts on Helmsman's computer into 2 holes near bulkhead wall.  
 B. Insert post on Admiral's console into hole near Admiral's chair. Snap tabs of helm stand into hole near Helmsman's computer. Insert purge valve into purge hole. Fit stanchion on bridge, as shown. Slide slots on deck ladder over ledge on top deck.

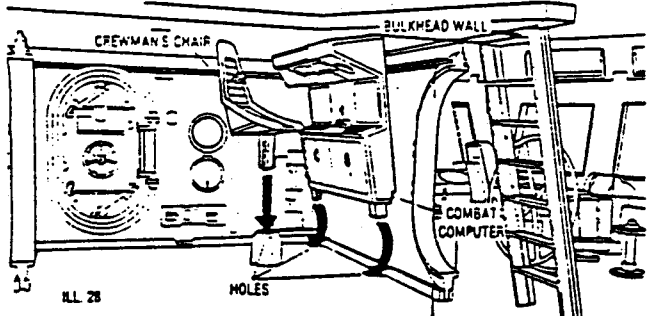

**COMBAT CONTROL ROOM (upper middle deck)**

- 28 Insert 2 posts on combat computer into 2 holes near bulkhead wall. Insert crewman's chair into chair post.

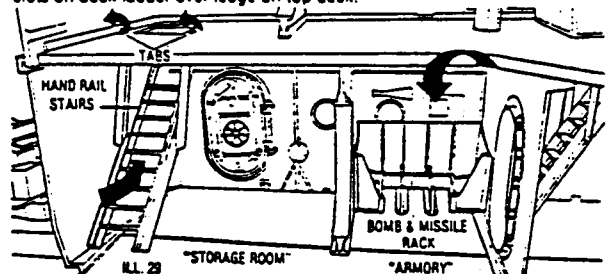

**STORAGE ROOM (lower left deck) ARMORY (lower middle deck)**

- 29 Place bomb and missile rack against rear wall of armory. Insert tabs on hand rail stairs into slots underneath upper deck and slide into place.

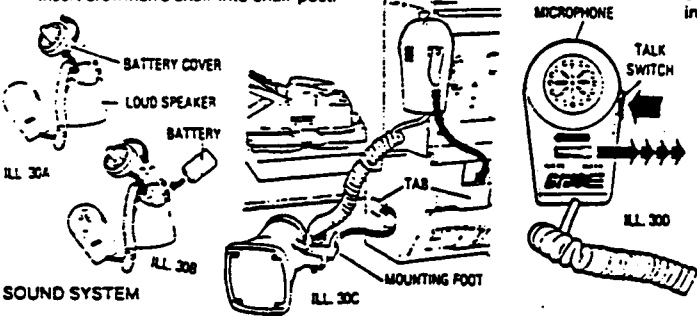

**SOUND SYSTEM**

- 30 A. Now hear this...Untwist battery cover from loud speaker.  
 B. Insert one 9-Volt battery into battery compartment as shown. Replace battery cover.  
 C. Slide mounting foot on loud speaker over tab on side of superstructure bottom. Slide mounting foot on microphone over tab on back of superstructure bottom, as shown.  
 D. Slide button on microphone for speaker or alarm mode. Press talk switch to give commands.

**MICROPHONE AIR RAID GENERAL QUARTERS ALL CLEAR!**

- 31 Place G.I. Joe ADMIRAL in the Admiral's chair and man all battle stations with the entire G.I. Joe Team! Includes G.I. Joe ADMIRAL, other figures sold separately

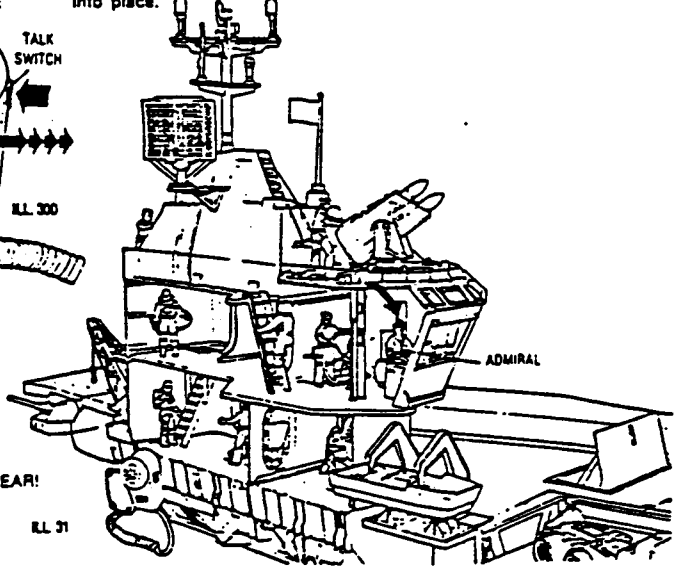

## U.S.S. FLAGG AIRCRAFT CARRIER

- 1) "LOW TOW" TRACTOR WITH HIGH TORQUE TRANSAXLE
- 2) ADMIRAL'S LAUNCH WITH STORAGE HATCH
- 3) ALLOY ARMORED FUEL DELIVERY TRAILER
- 4) U.S.S. FLAGG SOUND SYSTEM
- 5) FANTAIL DECK
- 6) AFT MISSILE CONTROL RADAR
- 7) GRAPHITE COMPOSITE ARRESTOR HOOK
- 8) "HOOK UP" 70-TON HYDRAULIC CRANE
- 9) BALLISTICS STORAGE ARMORY
- 10) PHASED ARRAY TARGETING RADOME
- 11) ARMORED RADAR BASE
- 12) FIRE CONTROL/COMBAT CENTER
- 13) AIR SEARCH NET RADAR
- 14) MISSILE BOX WITH ROTATION SERVO SYSTEM
- 15) TITANIUM FRAMED BLAST DEFLECTOR
- 16) ELEVATOR DECK
- 17) STARBOARD BOW SPONSON
- 18) BRIDGE WITH NAVIGATIONAL SYSTEM COMPUTERS
- 19) FORWARD MISSILE CONTROL RADAR
- 20) SEA ANCHORS
- 21) 76MM RAPID FIRE "BLASTER" ANTI-SHIP GUN

