

GARGOYLES XANATOS XI-44 ROADSTER

ASSEMBLY AND INSTRUCTIONS

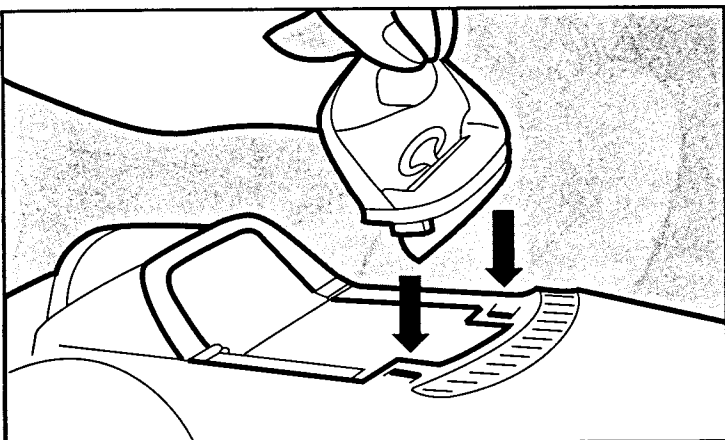

1 Snap windshield into position.

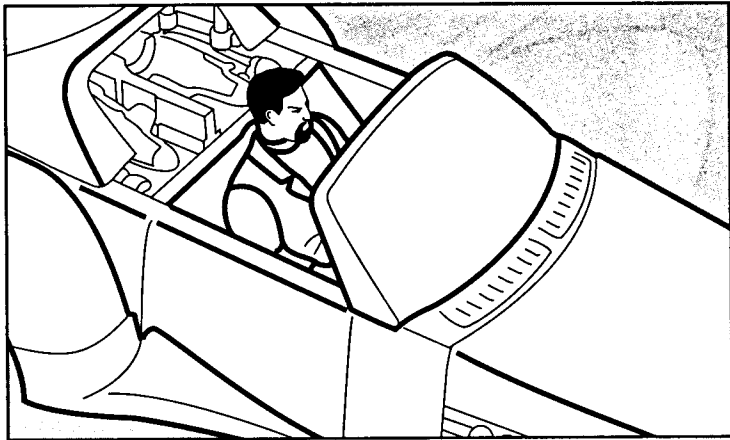

2 Place figure in vehicle as shown.

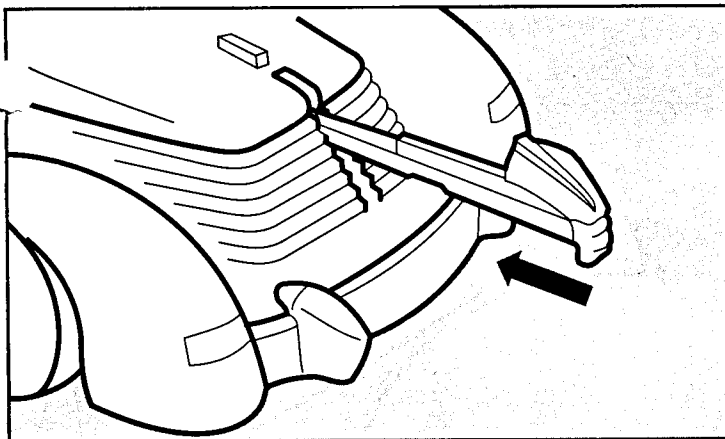

3 Load hood ornament missile all the way into front of vehicle.

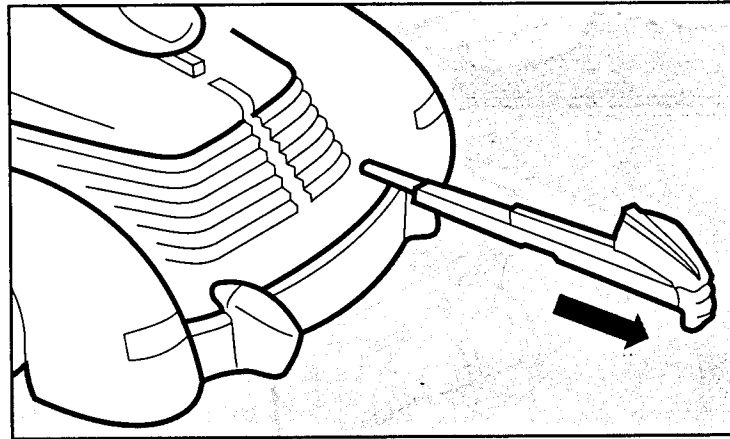

4 Press firing button to launch hood ornament missile.

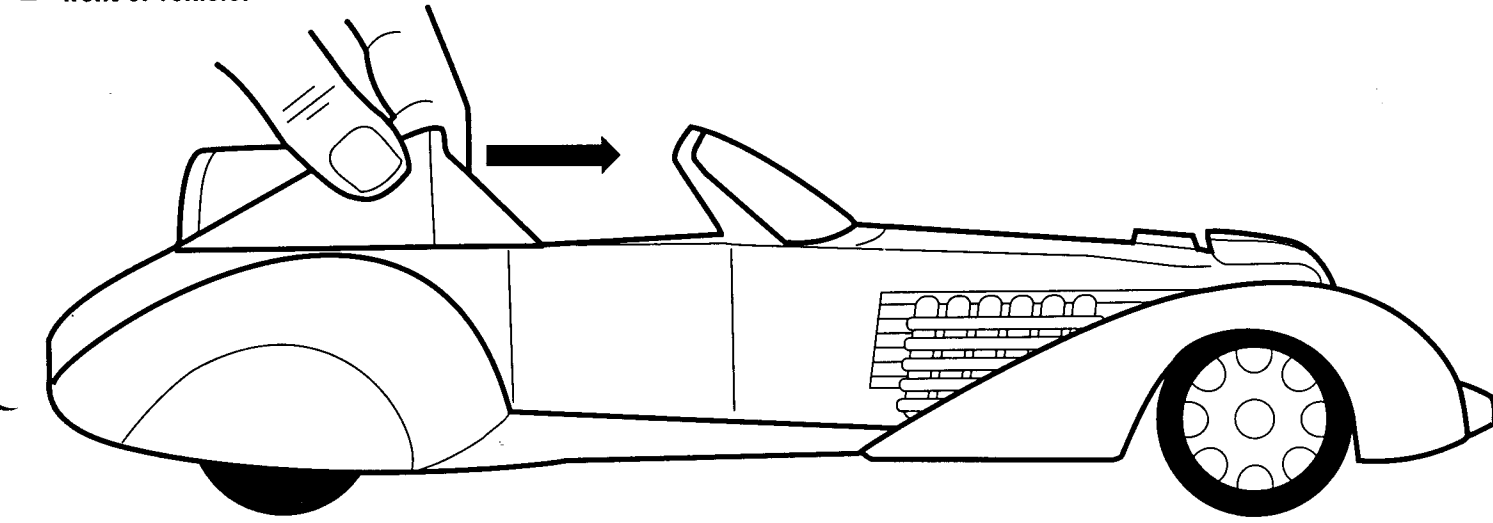

5 Slide roof forward to hide figure and expose thruster compartment.

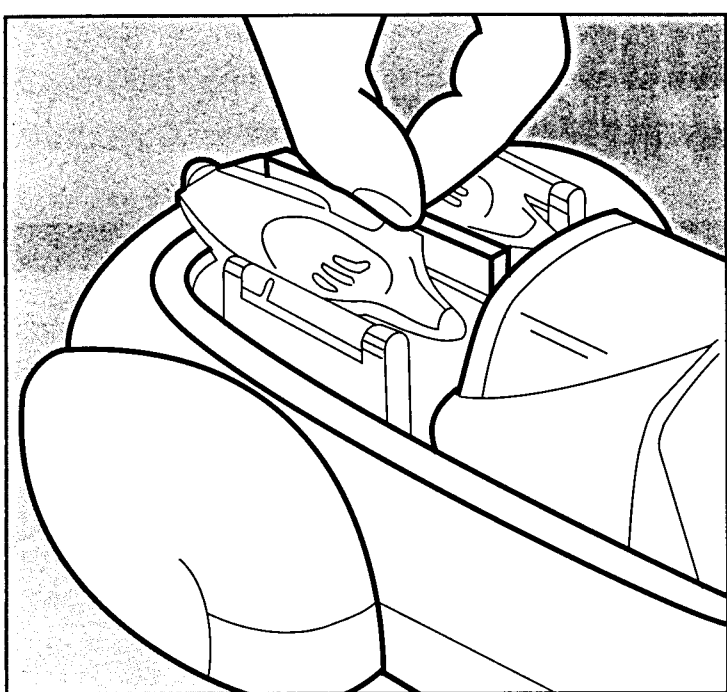

6 Pull thruster compartment up.

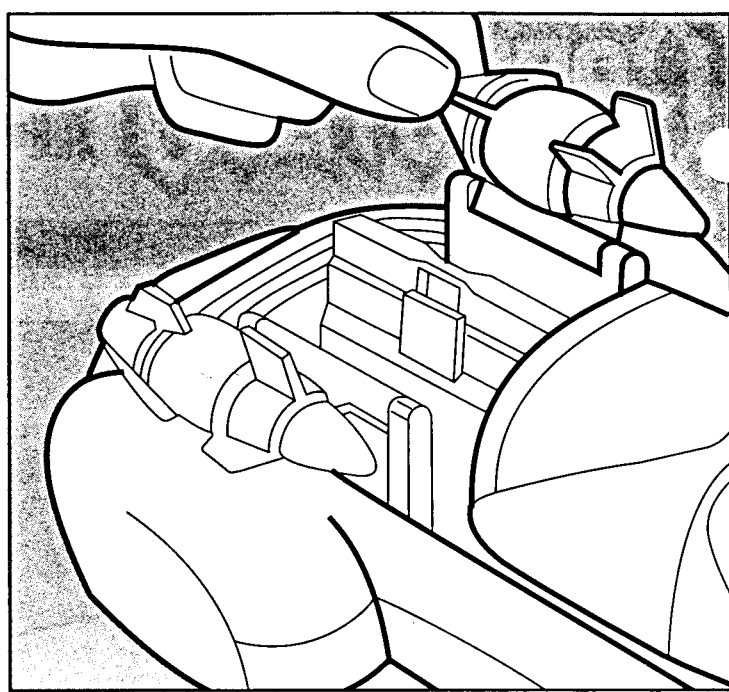

7 Rotate each thruster outward.

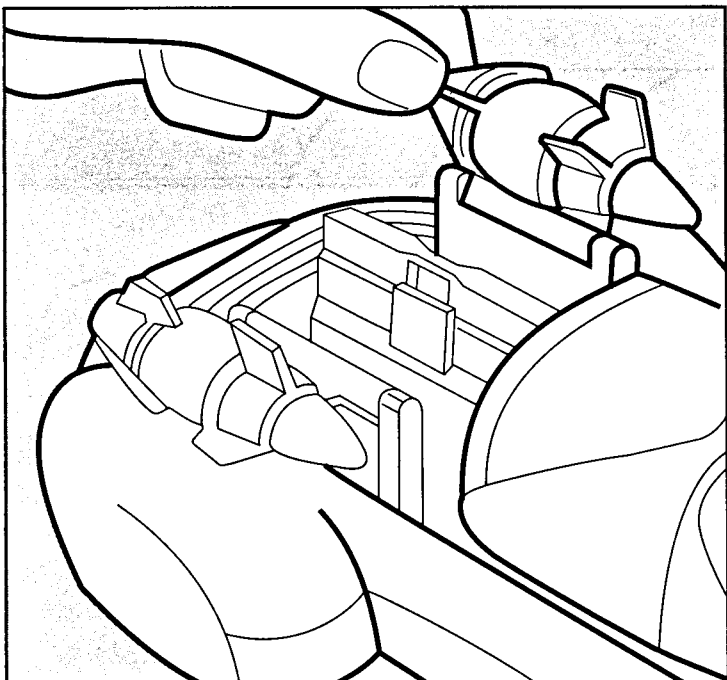

8 Replace each thruster by rotating back into compartment.

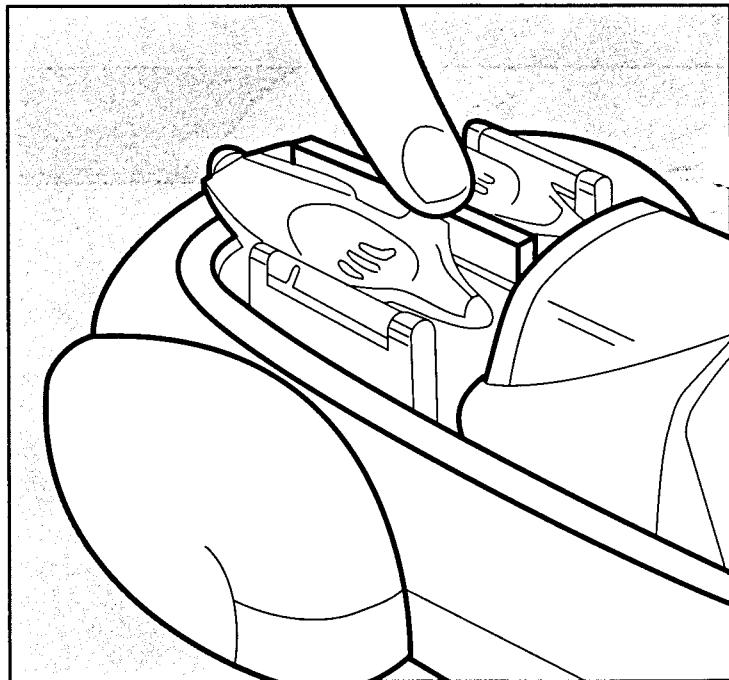

9 Push thruster compartment down. Slide roof back to cover thruster compartment.

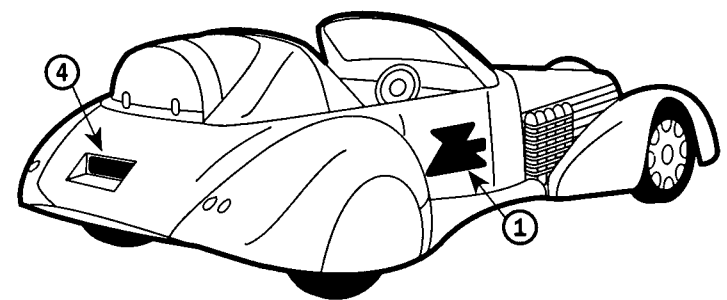

10 Apply labels using the numbers on the label sheet and these illustrations as a guide.

