

**WARNING:**  
CHECKING HEAD-AND-NECK PARTS  
Not for children under 3 years.

## COBRA® RATTLER® 4-WD INSTRUCTIONS

Some assembly required - no tools necessary.

Remove all pieces from runners. If you have difficulty use safety scissors.

**Contains:** Chassis with wheels, body, ram bar, steering wheel, 2 rear deck panels, hand rail, refueling tank, rocket launcher, 4 rockets, roof panel, 2 doors, rear platform, driver figure, label sheet and instructions.

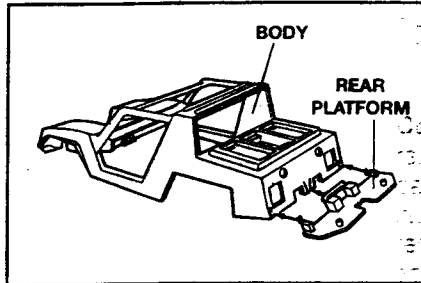

1. Insert rear platform into rear of body as shown.

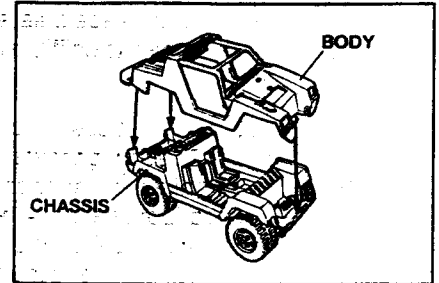

2. Press body onto chassis

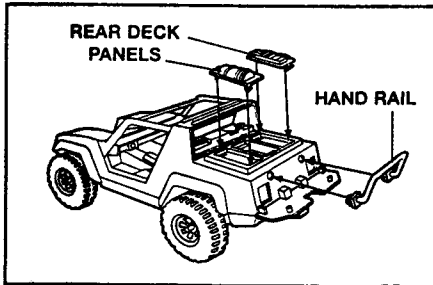

3. Snap rear deck panels onto rear of body. Press rear hand rail into slots in back of body.

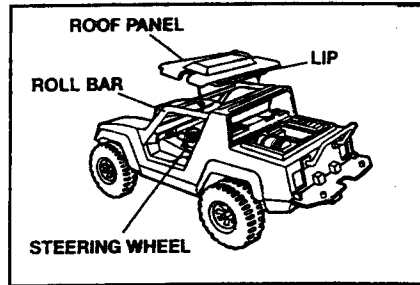

4. Line up tab on steering wheel column with slot in dashboard. Press steering wheel firmly into place. Place lip of roof panel under the back of roof frame and snap front of roof panel down onto roll bar as shown.

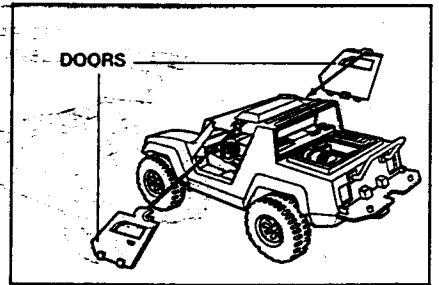

5. Snap doors onto roll bar as shown.

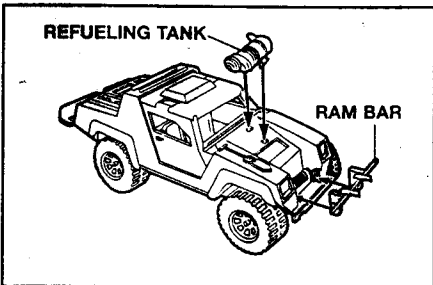

6. Snap refueling tank onto hood. Insert one side of ram bar into bracket on front of body. Flex other side into opposite bracket.

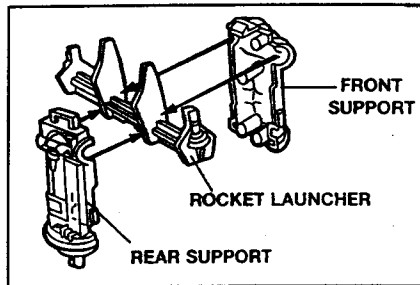

7. Trap rocket launcher between front and rear of rocket launcher support. Snap closed.

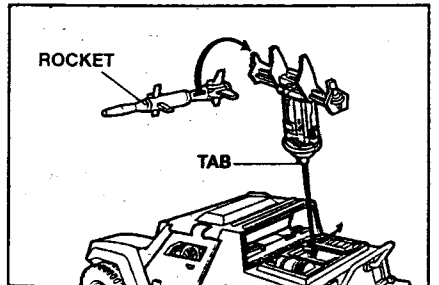

8. Line up tab on rocket launcher support with slot on body as shown. Insert and twist to lock assembly into place. Press rockets onto launcher. Place driver into the driver's seat.

9. Peel and apply labels as shown.

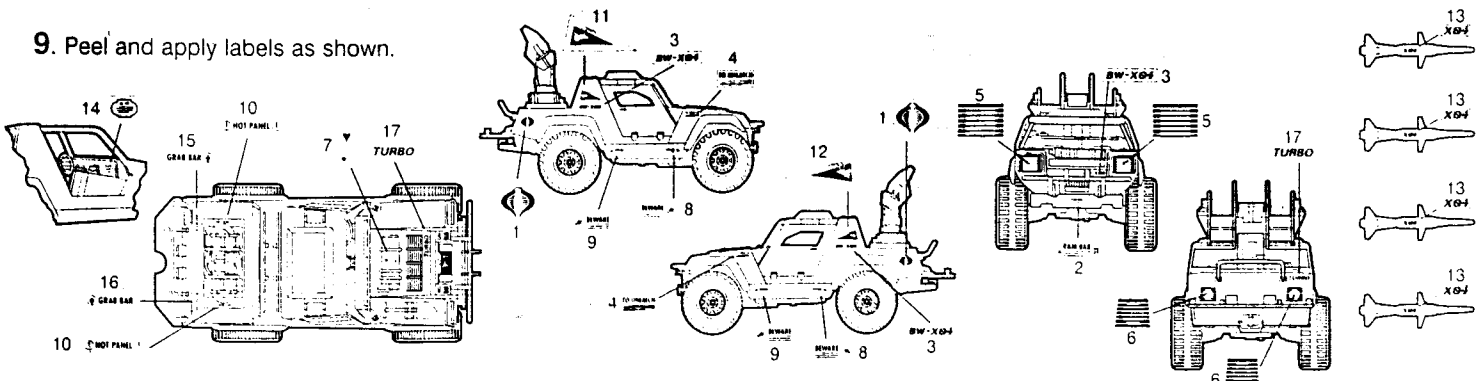

**COBRA® RATTLER® 4-WD**

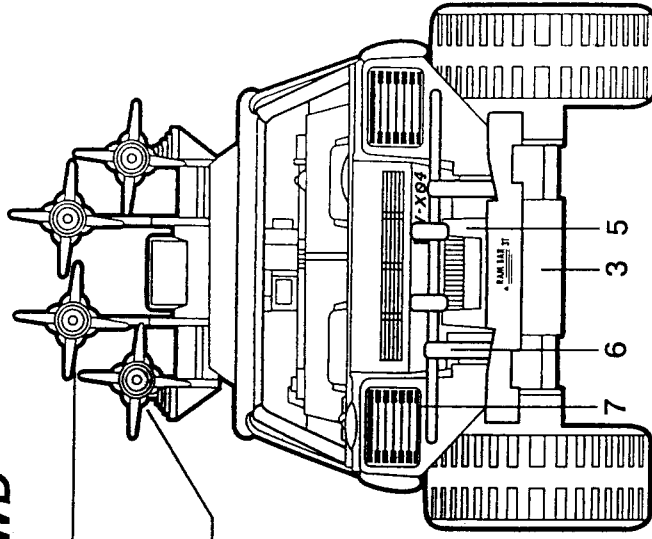

1. OFF-ROAD TIRES ON ALLOY WHEELS
2. URETHANE FENDER FLARES
3. 4.8 LITER V-12 FUEL INJECTED TWIN-TURBO ENGINE  
RANGE: 550 MILES  
TOP SPEED: 140 MPH
4. HOOD HOLD-DOWN PINS
5. HEAVY-DUTY WINCH
6. RAM BAR
7. HALOGEN HEADLAMP WITH ELECTRONIC DEFROSTERS
8. ROLL BAR
9. TOW HOOK
10. ROCKET LAUNCHER  
360° ROTATION
11. GROUND-TO-AIR ROCKETS
12. GULL-WING DOORS
13. REAR DECK PANELS
14. REFUELING TANK
15. ROOF PANEL

