

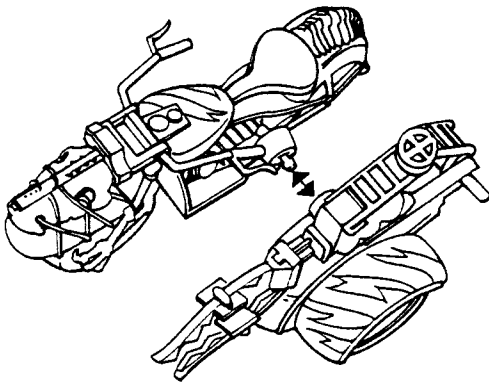

# EVIL RAIDERS™ STRIKE CYCLE™ VEHICLE

## ASSEMBLY

1. Attach handle bars to bike, one side at a time, as shown.

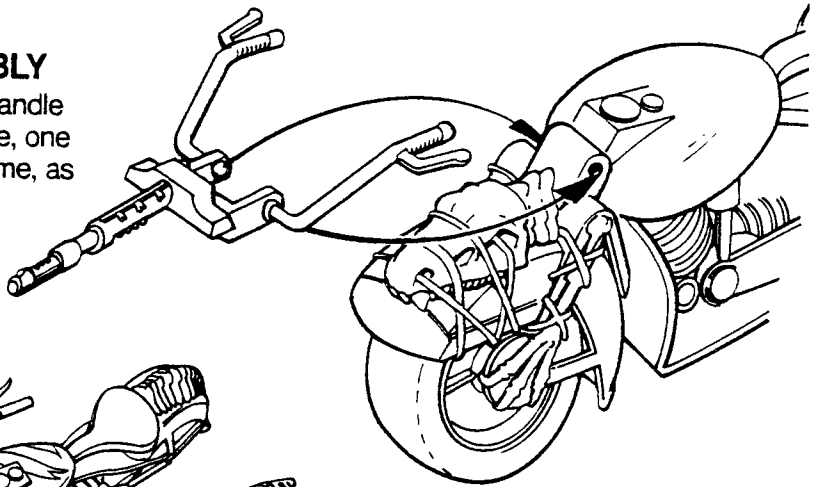

2. Snap sidecar onto bike.

3. Locate take-up wheel at back of sidecar. Turn wheel to take up all of the string. Then load capture claw into launcher until it snaps into place.

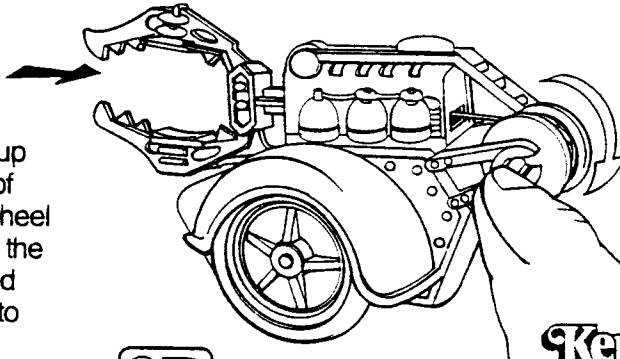

**Kenner®**

4. Raise sight. Press firing button to fire capture claw. Lower sight.

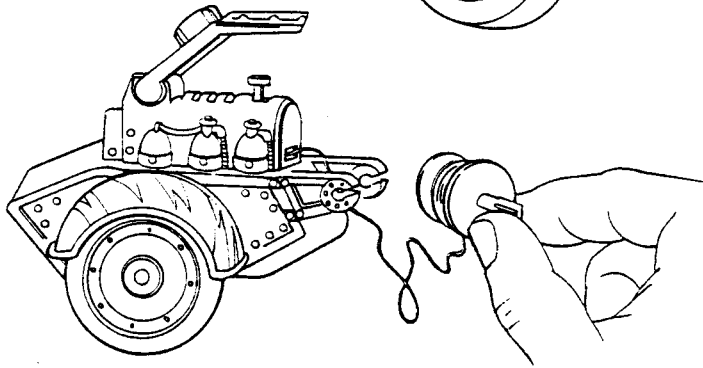
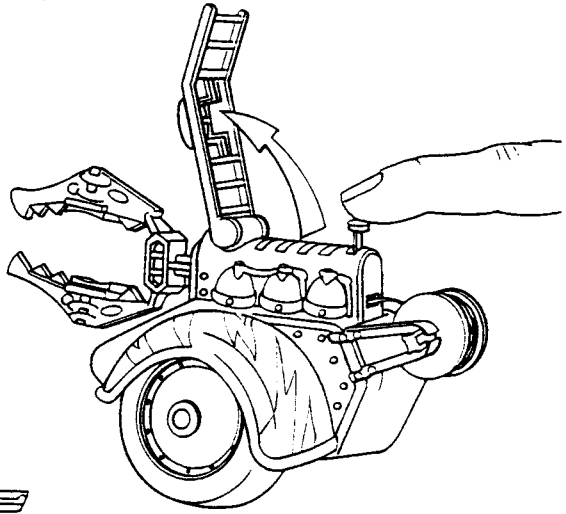

5. You may remove take-up wheel to untangle string, if necessary.

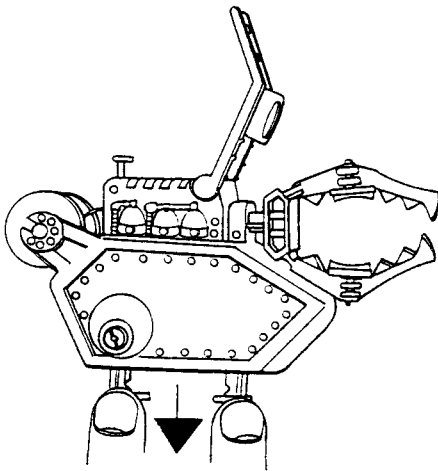

6. Sidecar has two legs that should be lowered when it is not attached to bike.

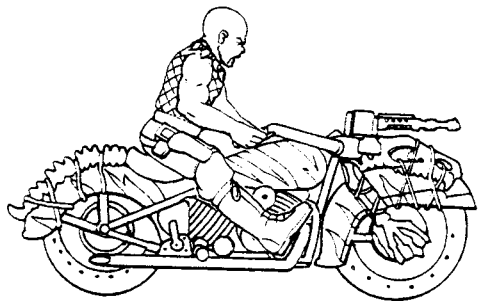

7. Figure rides on bike as shown.