



Birth & Up
6537

Music 'n Lights Kick Start[®] Gym

WARNING: NEVER leave child unattended.

To avoid injury and to prevent possible strangulation and entanglement injury

NEVER place gym in crib or playpen.

NEVER add strings, ties or other products to gym.

CAUTION: This product contains screws which are small parts and necessary for assembly. Prior to and during assembly of this product, keep small parts out of children's reach. Small parts pose a choke hazard to children under 3 years.

Requires 3 "AA" alkaline batteries (not included).

Adult assembly and Phillips screwdriver (not included) required.

Parts include: kick panel, 2 legs, 2 arms, electronic housing (with bee and butterfly), 6 medium screws (#8-3/4"), 2 long screws (#6-1 7/8"), 3 flipping flowers, flower stem, 2 beads.

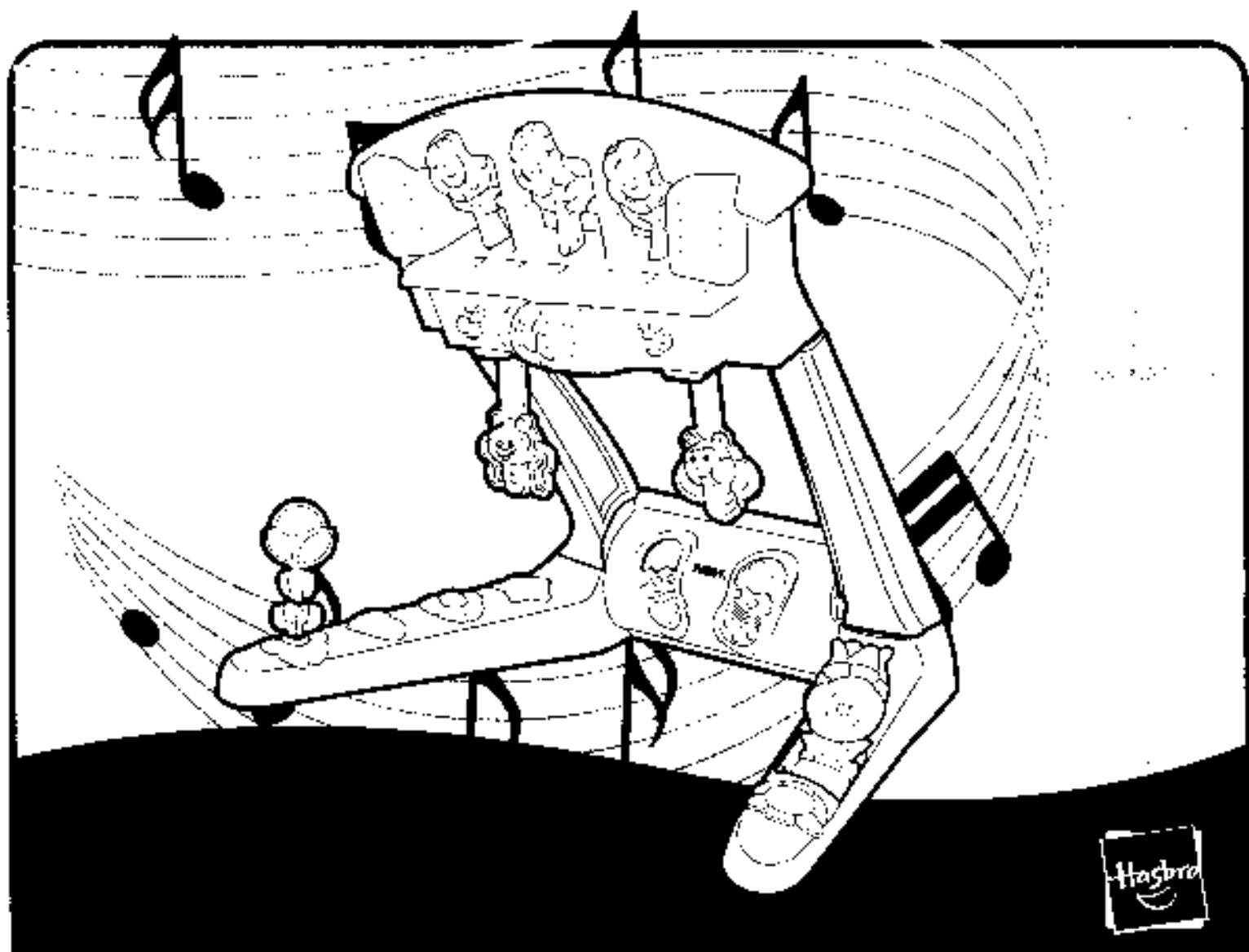

ASSEMBLY

STOP! DO NOT Insert Arms (Yellow Pieces) Into Legs (Green Pieces) Before Attaching Kick Panel (Blue Piece) Assembly To Legs!

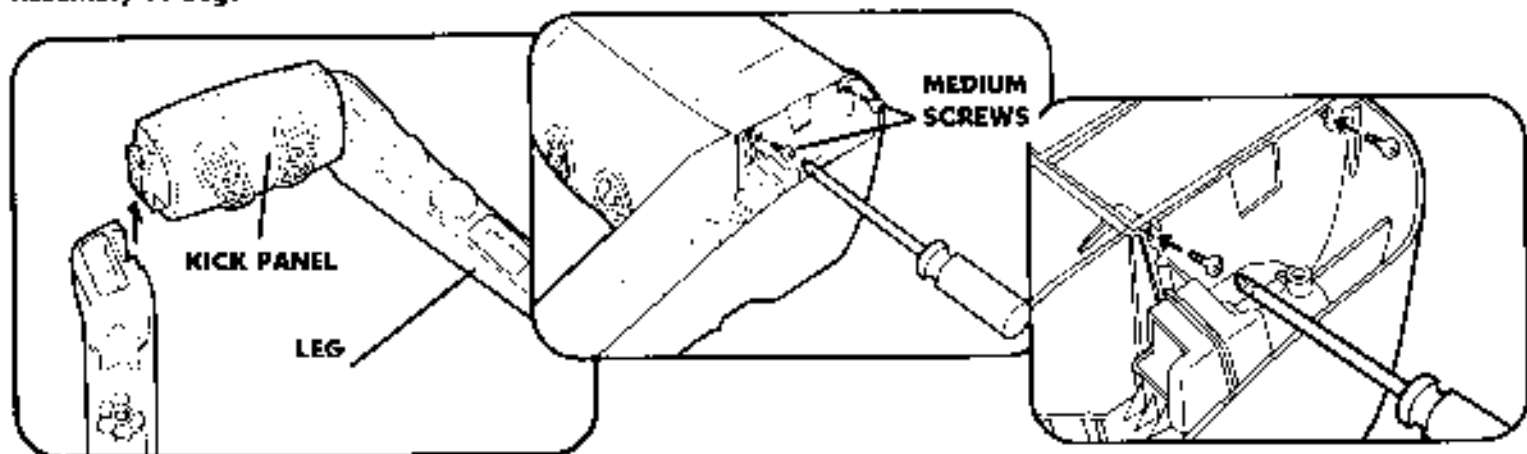

1. Attach kick panel to legs. Turn assembly upside down and place on flat surface. Using 4 medium screws and Phillips screwdriver, secure kick panel to legs.

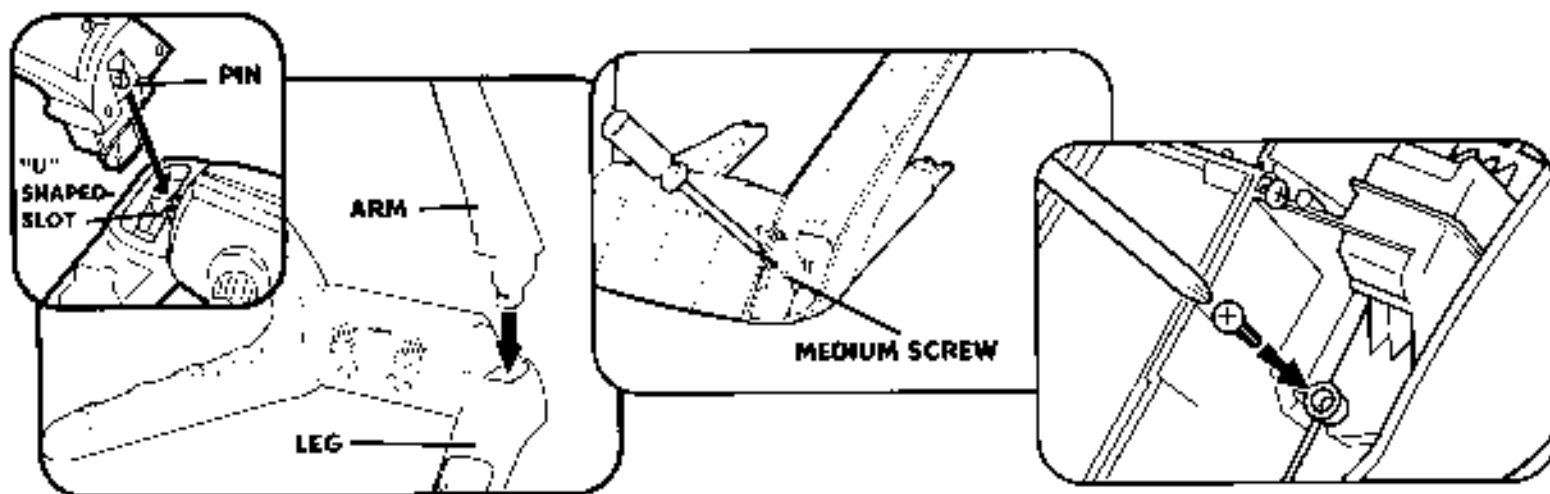

2. Remove labels covering openings in legs. Snap arms into legs: When attaching right arm, make sure pin on arm goes into "u"-shaped slot on side of kickboard. Turn assembly upside down. Using 2 remaining medium screws and Phillips screwdriver, secure arms to legs.

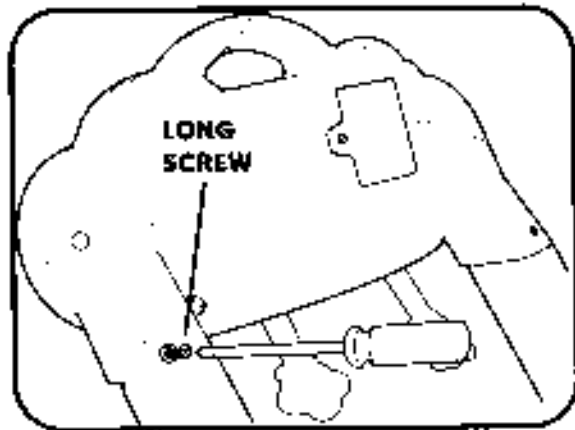
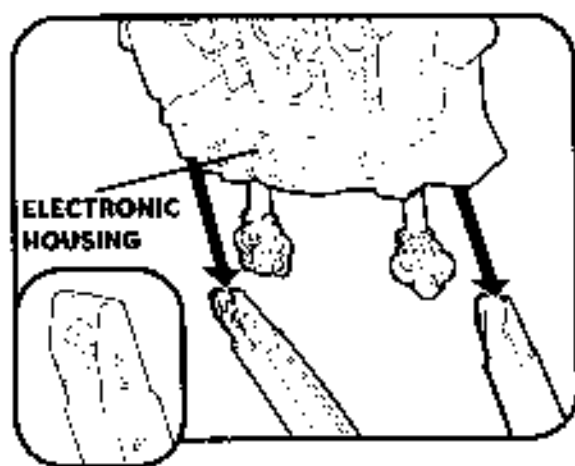

3. Turn assembly right side up. Slide electronic housing onto arms. Secure housing to arms using 2 long screws and Phillips screwdriver.

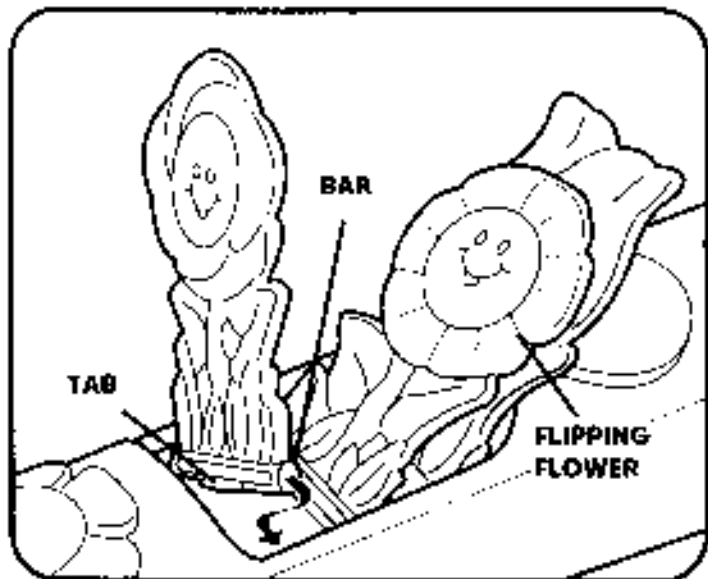

4. Flipping flowers attach only one way. With front of assembly facing you, hold flower with tab on bar facing you. Snap bar into recessed area in leg. Repeat for remaining flowers.

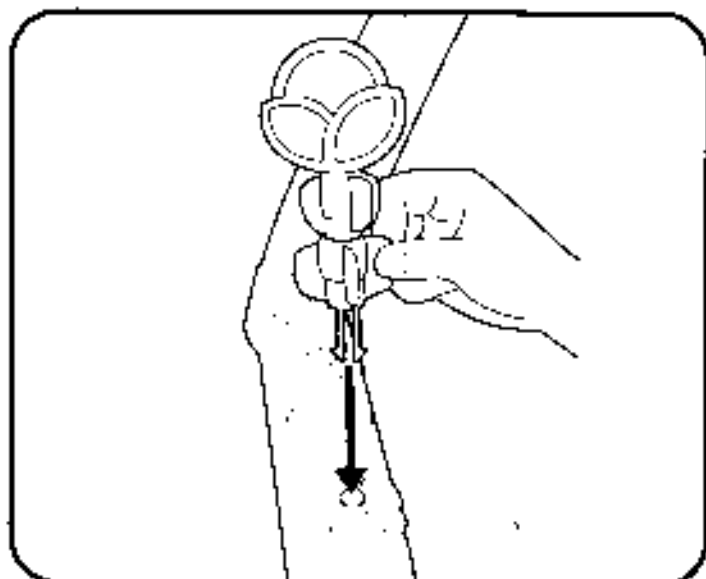

5. Slide beads over end of flower stem with tab. Snap end of stem into hole in assembly leg.

TO INSERT BATTERIES

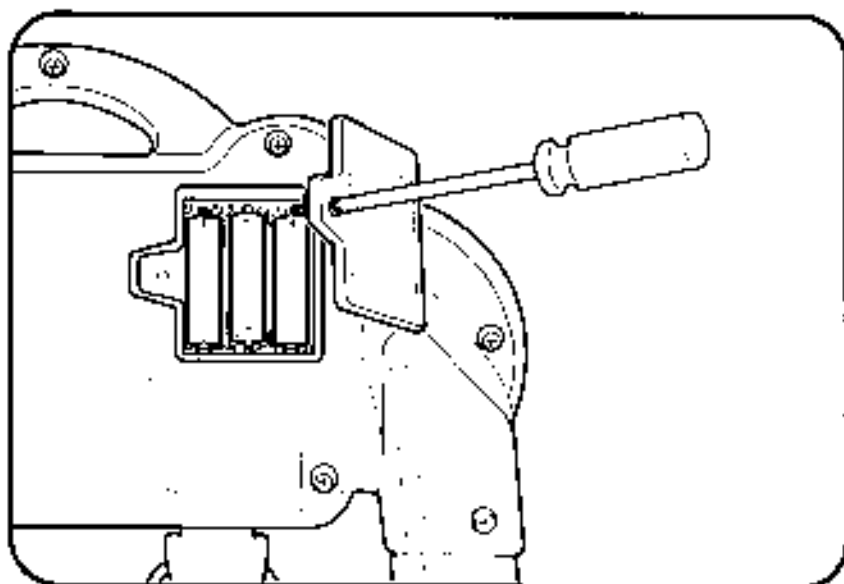

With Phillips screwdriver, loosen screw in battery compartment door on back of electronic housing (screw will remain attached to door). Remove door. Insert 3 fresh "AA" alkaline batteries into compartment. Replace door and tighten screw with screwdriver.



CAUTION: TO AVOID BATTERY LEAKAGE

1. Be sure to insert the batteries correctly and always follow the toy and battery manufacturers' instructions;
2. Do not mix old and new batteries or alkaline, standard (carbon-zinc) or rechargeable (nickel-cadmium) batteries;
3. Always remove weak or dead batteries from the product.

TO PLAY

Choose mode with switch on back of electronic housing. (Center position is OFF.)

Activate toy:

- In  mode: When baby kicks kick panel or bats dangling toy, gym plays approximately 5 minutes of music and silly sounds as lights flash. When 5 minutes are up, baby kicks or bats to start the music, sounds and lights all over again!
- In  mode: Each time baby kicks kick panel or bats dangling toy, lights will flash and you'll hear a silly sound and part of a song.

AUTOMATIC SHUT-OFF

If toy is left inactive, the electronics will automatically shut off.

PLACEMENT OF TOY

Some babies kick harder than others. To prevent gym from slipping, place gym on a carpet with back of gym braced against a piece of furniture or wall.

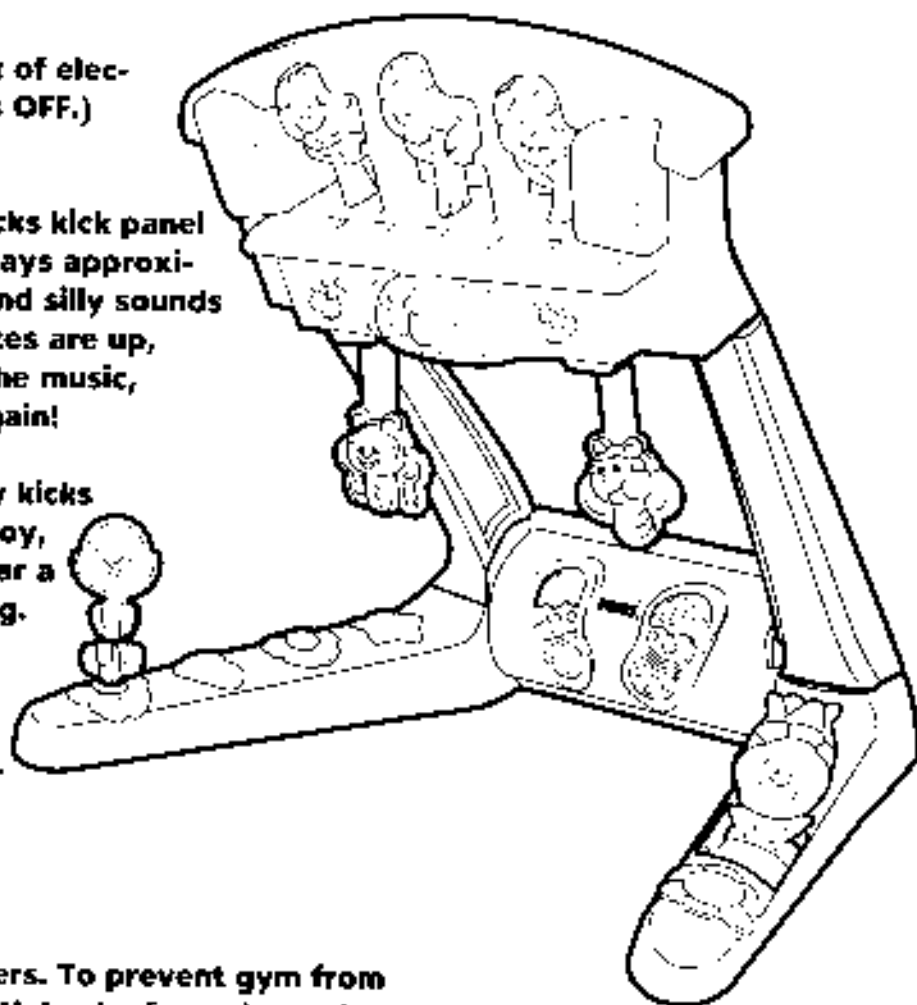

FCC STATEMENT

This equipment has been tested and found to comply with the limits for a Class B digital device, pursuant to part 15 of the FCC Rules. These limits are designed to provide reasonable protection against harmful interference in a residential installation. This equipment generates, uses and can radiate radio frequency energy, and, if not installed and used in accordance with the instructions, may cause harmful interference to radio communications. However, there is no guarantee that interference will not occur in a particular installation. If this equipment does cause harmful interference to radio or television reception, which can be determined by turning the equipment off and on, the user is encouraged to try to correct the interference by one or more of the following measures:

- Reorient or relocate the receiving antenna.
- Increase the separation between the equipment and the receiver.
- Consult the dealer or an experienced radio/TV technician for help.

Changes or modifications not expressly approved by the party responsible for compliance could void the user's authority to operate the equipment.