

PLAYSKOOL

Krystal Princess™

WARNING: Contains small parts which may present a choking hazard to children under three.



Questions? Call:
1-800-PLAYSKL™

For future reference, our toll-free consumer service number is also located on this product.

Krystal Kastle

Includes: Krystal Kastle, ramp, medallion, drawbridge, center platform, swan swing, dome swing seat, 2 dome swing sides, 2 swing arches, 4 arch feet, 4 pieces of trim, bed, table, 2 thrones, label sheet and instruction sheet.

ADULTS: REMOVE PIECES FROM PLASTIC BAG AND DISCARD BAG IMMEDIATELY.

TO ASSEMBLE THE KRYSTAL KASTLE

TURRET TRIM

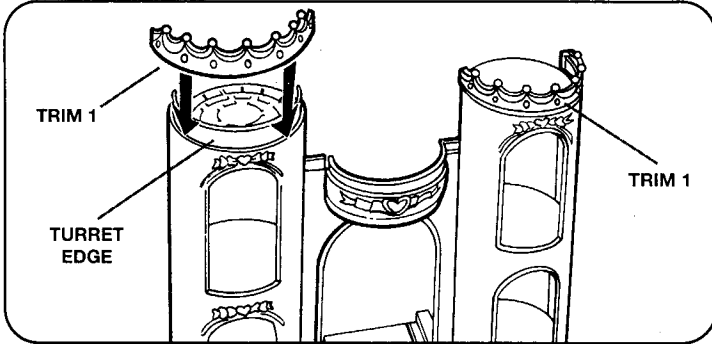

1. Locate both pieces of trim with "1" molded on the back. With front of Krystal Kastle facing you, slip ends of turret trim over turret edges. Slide trim down until it snaps into place. Attach other turret trim in same manner.

BALCONY TRIM

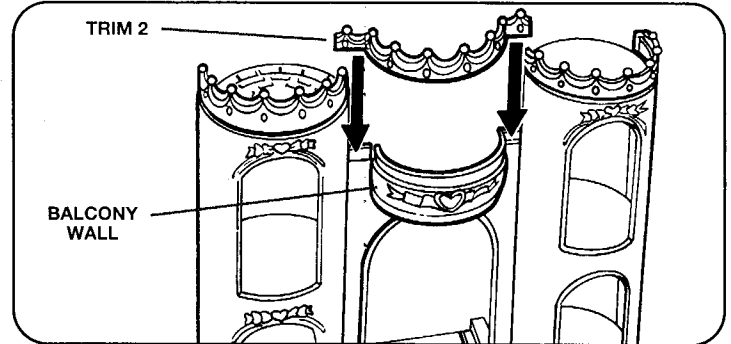

1. Locate trim with "2" molded on the back. Slip ends of trim over tabs on balcony wall. Slide trim down until it snaps into place.

MAGIC WINDOW MEDALLION AND DRAWBRIDGE

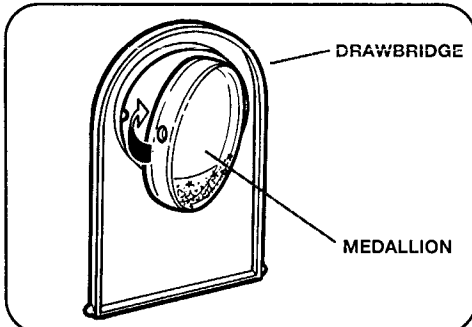

1. To insert magic window medallion into drawbridge, fit indentation on one side of medallion over knob on one side of drawbridge hole. Press indentation on other side of medallion over knob on other side of hole.

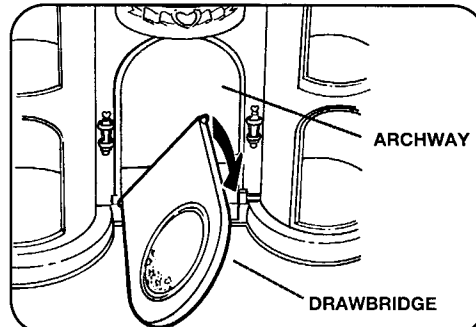

2. To attach drawbridge to Kastle, insert knob on drawbridge into hole in one side of archway. Snap other knob into hole in other side of archway.

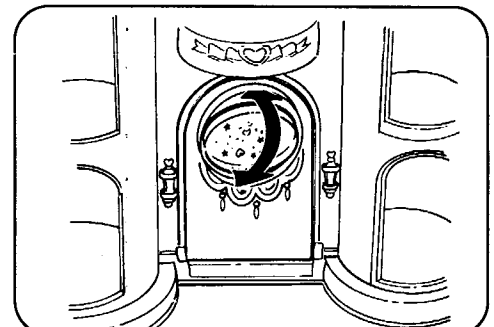

3. Swing the drawbridge up, and spin the magic window medallion for a Krystal shower!

RAMP

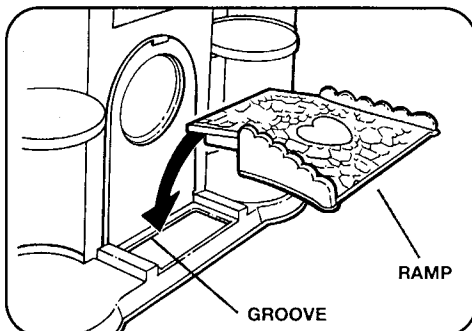

1. Turn Krystal Kastle so that inside faces you. Fit ridge on ramp into groove in center of base.

CENTER PLATFORM

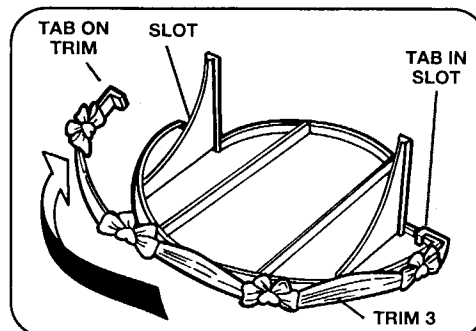

1. Locate trim with "3" molded on the back. With center platform and trim upside down, insert tab on trim into slot in platform. Holding tab in place, bend trim around edge of platform, and slide tab into slot.

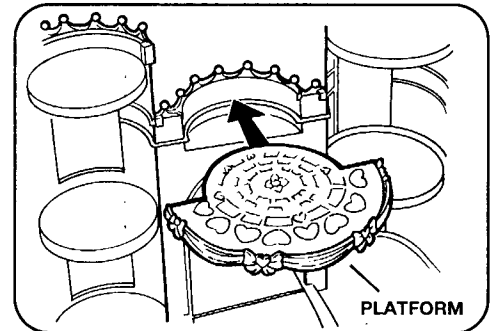

2. Turn center platform right side up. Press it firmly into center of Kastle.

TO ASSEMBLE THE SWINGS

FOR BOTH ARCHES:

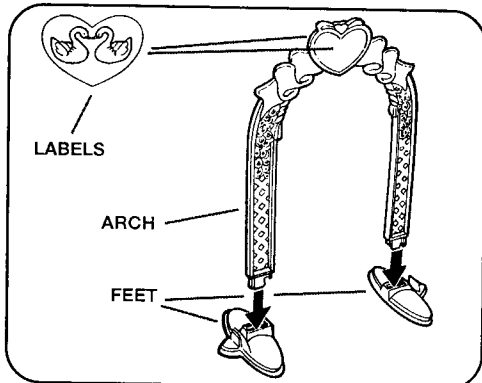

1. Peel and apply a heart label to each side of arches, as shown.
2. Insert tabs on arches into slots in feet.

FOR DOME SWING:

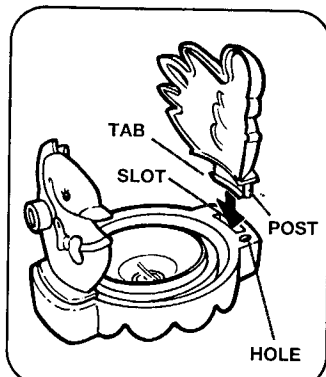

3. Align post and tab on right side of swing with hole and slot in swing seat, then press side into seat. Repeat for left side.

FOR SWAN SWING:

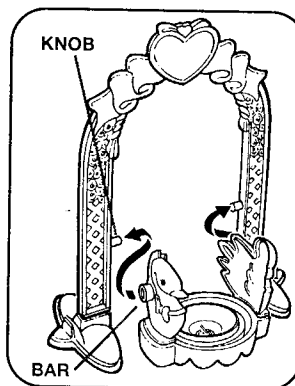

4. Fit bar on one side of swing over knob in arch. Gently squeeze sides of swing, and fit opposite bar over opposite knob.

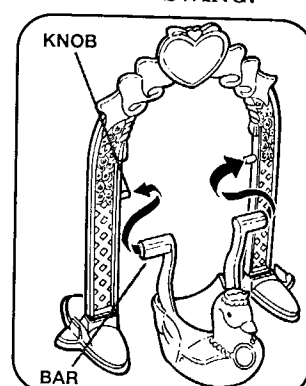

5. Fit bar on one side of swing over knob in arch. Gently squeeze swing sides, and fit opposite bar over opposite knob.

PLAYTIME!

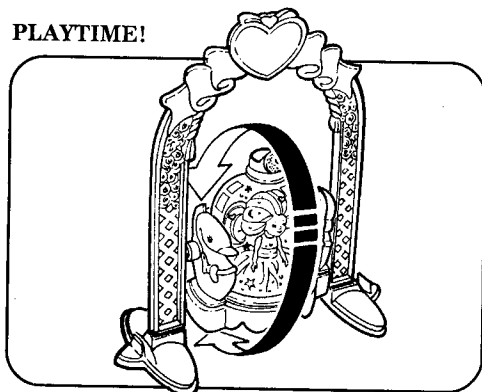

6. Spin a Krystal Princess in the DOME SWING! Press a Krystal Princess's feet into the slots in the seat so that she is standing up. Slip a dome over the princess, and press down on the dome until it is securely attached to the base. Now, give your Krystal Princess a whirl and watch the Krystals swirl! DOLL AND DOME NOT INCLUDED.

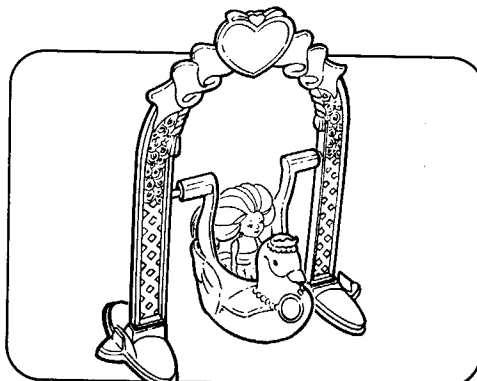

7. Give a Krystal Princess a ride on the SWAN SWING! Pose a princess in a seated position and place her in the swing. Now, give the swing a gentle push! DOLL NOT INCLUDED.

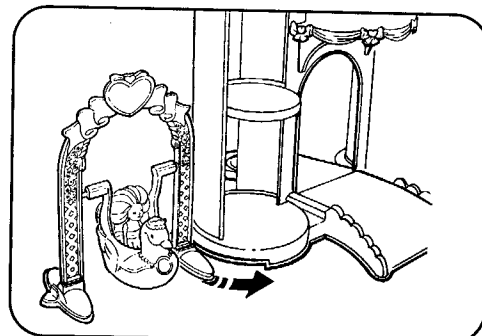

8. "Attach" the swings to the Krystal Kastle! Just place the edge of an arch foot under either end of Krystal Kastle base, and slide swing to different positions.

THRONES

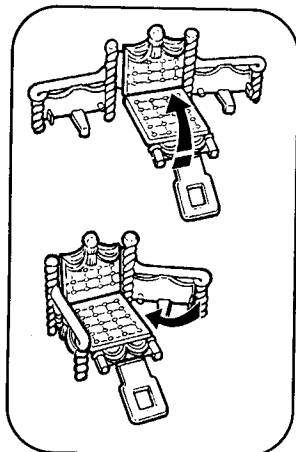

1. Fold seat up. Swing arms in.

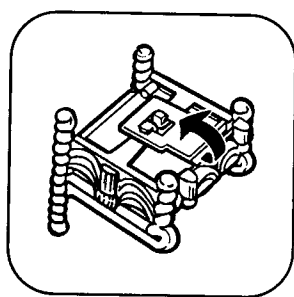

2. Fold catch under throne and hook it over tabs. Repeat for other throne.

TO DISPLAY KRystal PRINCESSES AND THEIR DOMES

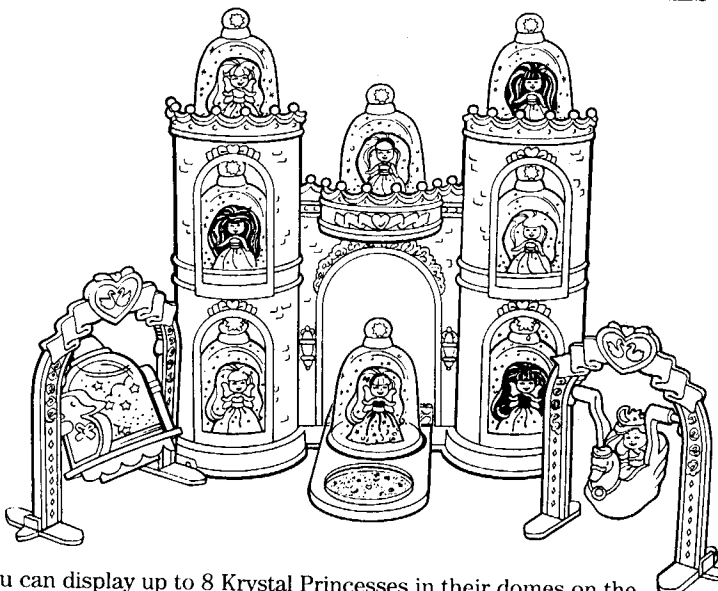

1. You can display up to 8 Krystal Princesses in their domes on the platforms and floor of the Krystal Kastle! You can also display a Krystal Princess and her dome on the dome swing, and give another Krystal Princess a ride in the swan swing. DOLLS AND DOMES NOT INCLUDED.