

Lite Brite

AGES 4+

07705

Cube 2.0

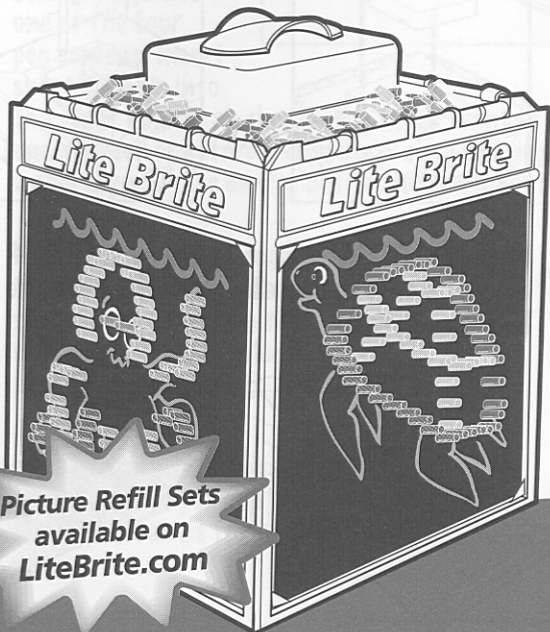

Thank you for purchasing this LITE-BRITE product!

Please read and follow these instructions carefully and retain them for future use.

Includes: LITE-BRITE Cube (6 pieces), light bulb, 300 pegs and 8 design picture sheets.

ADULT ASSEMBLY REQUIRED.



WARNING:

CHOKING HAZARD- Small parts.
Not for children under 4 years.

TO INSTALL BATTERIES

Unscrew battery door from the battery compartment using a Phillips head screwdriver.

Place 3 x 1.5V "C" or R14 size alkaline batteries in the battery compartment and replace door.

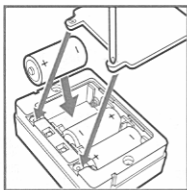

CAUTION: TO AVOID BATTERY LEAKAGE

1. Be sure to insert the batteries correctly and always follow the toy and battery manufacturers' instructions;
2. Do not mix old batteries and new batteries or alkaline, standard (carbon-zinc) or rechargeable (nickel-cadmium) batteries;
3. Always remove weak or dead batteries from the product.

IMPORTANT: BATTERY INFORMATION

Please retain this information for future reference. Batteries should be replaced by an adult.



CAUTION:

1. Always follow the instructions carefully. Use only batteries specified and be sure to insert them correctly by matching the + and - polarity markings.
2. Do not mix old batteries and new batteries, or standard (carbon-zinc) with alkaline batteries.
3. Remove exhausted or dead batteries from the product.
4. Remove batteries if product is not to be played with for a long time.
5. Do not short-circuit the supply terminals.
6. Should this product cause, or be affected by, local electrical interference, move it away from other electrical equipment. Reset (switching off and back on again or removing and re-inserting batteries) if necessary.
7. RECHARGEABLE BATTERIES: Do not mix these with any other types of battery. Always remove from the product before recharging. Recharge batteries under adult supervision. **DO NOT RECHARGE OTHER TYPES OF BATTERIES.**

ASSEMBLY

1. Place the battery compartment onto the cube base by lining up the grooves as shown. Flip the cube base over and screw in the battery compartment as shown.

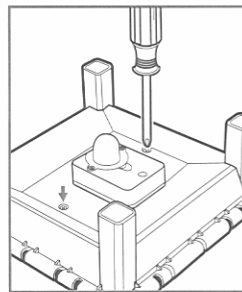
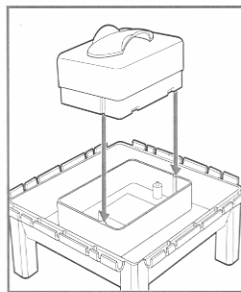

2. With the LITE-BRITE logos facing up, snap all 4 cube sides onto the base by connecting them to the hinges as shown.

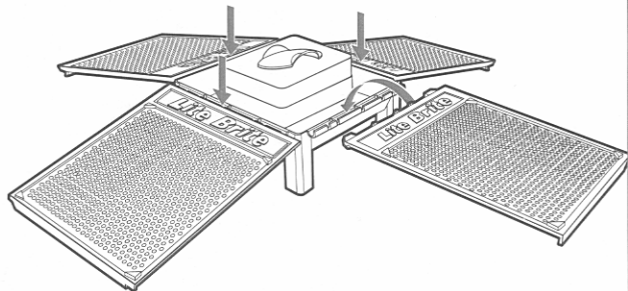

TO PLAY

1. Tear the picture sheets along the perforated lines.

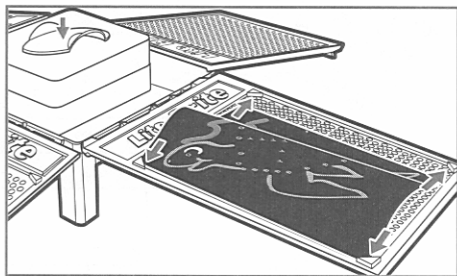

2. Place a picture sheet flat and straight against one of the four peg screens. Insert sheet corners into the sheet holders as shown. You might want to put all four underwater or safari sheets on at once and peg them to make a cool scene! Press center button to illuminate before pegging.

3. To create a picture, follow the printed letters on the sheet to tell which colored pegs to use (see chart).

COLOR CHART

LETTER ON PICTURE	COLOR PEGS TO USE
R	RED
B	BLUE
O	ORANGE
W	WHITE
G	GREEN
Y	YELLOW
P	PINK
V	VIOLET

4. Insert the colored pegs through the paper and into the peg screen as far as they will go.

5. When you are finished pegging, lift the cube base up and fold the sides down. Snap the side corners together to stand.

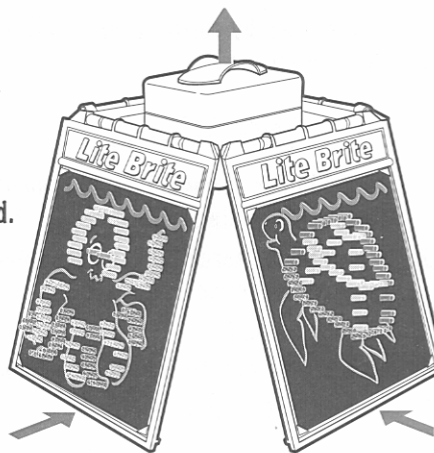

6. Press the center button to illuminate your pictures!

Store pegs in the cube base tray as shown.

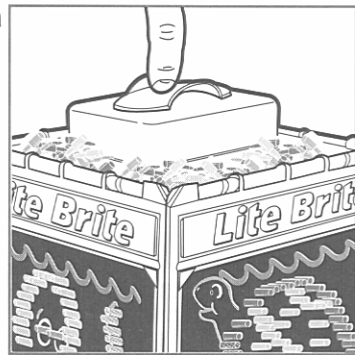

TO ORDER AND REPLACE LIGHT BULB

Order light bulb by contacting HASBRO at 1-800-327-8264. (Bulb is not available in stores.)

REPLACING BULBS:

1. Use a Phillips screwdriver to remove 2 screws from the collar. Remove the collar.
2. Use a Phillips screwdriver to remove 1 screw from the cover. Remove the cover.
3. Remove gasket.
4. Push gently and twist counterclockwise to remove bulb.
5. Replace with a new bulb.
6. Refasten gasket, cover and collar.

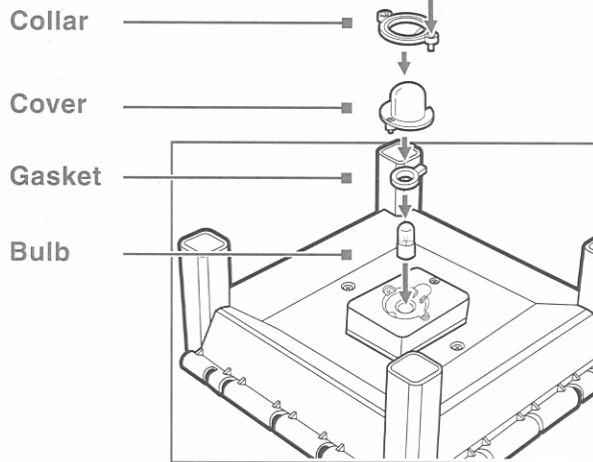

Picture refill sets available on [Litebrite.com!](http://Litebrite.com)

© 2004 Hasbro. All Rights Reserved.
© denotes Reg. U.S. Pat. & TM Office.
U.S. Patent No. 6729932
07705 P/N 6461530000



Questions? Call: 1-800-327-8264