

81348



WARNING:

CHOKING HAZARD - Small parts.
Not for children under 3 years.

Ages 5 & Up



MORTAL KOMBAT™

CONTAINS: Figure, Two Pontoon Assemblies, Deck, Left and Right Hulls, Two Hull Wheels, Two Pontoon Wheels, Two Battle Decks, Hatch Cover, Main Sail, Rear Sail, Steering Wheel Assembly, Mast, Two Rope Ladders, Harpoon Reel, Harpoon, Launcher and Label Sheet.

DRAGON WING™ OFFICIAL SPECIFICATIONS

1. MYSTICAL MAIN SAIL
2. REAR STEERING SAIL
3. SHOOTING SORCERER
CANNON
4. BATTLE HARPOON
5. HARPOON REEL
6. HIDDEN ROLLING WHEELS (2)
7. STABILIZING PONTOONS (2)
8. ROPE LADDERS (2)
9. SIDE BATTLE DECKS (2)
10. FOLDING SHIP'S WHEEL

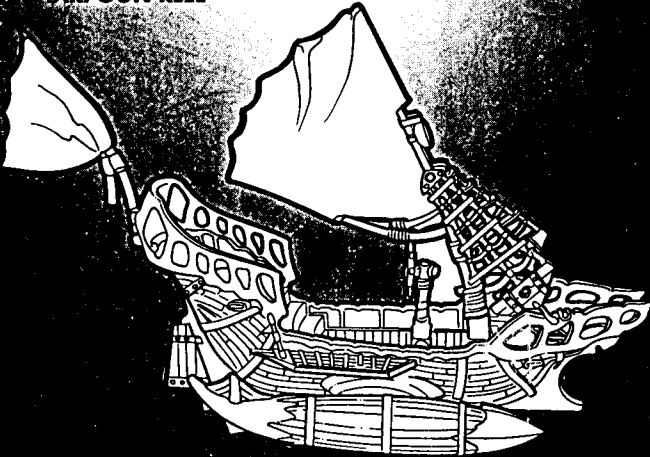

Remove all pieces from plastic frames. If you have difficulty use safety scissors.
CAUTION: Do not point weapon at eyes or face.

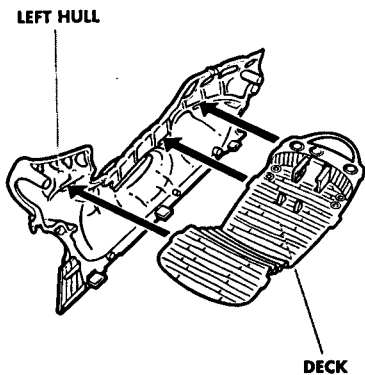

DECK INSTALLATION

1. Insert tabs on deck into corresponding slots on left half of hull. Snap into place.

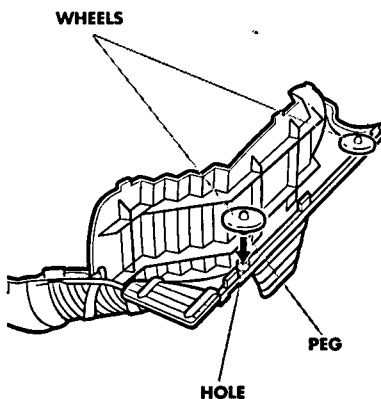

WHEEL INSTALLATION

2. Insert wheel pegs into holes on left half of hull.

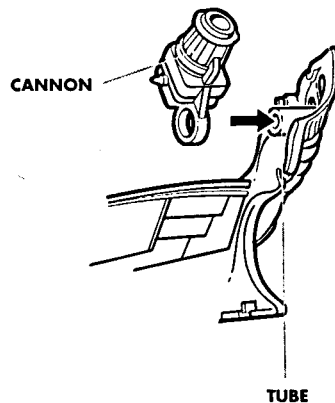

SORCERER CANNON INSTALLATION

3. Slide ring on cannon over tube on left hull.

PONTOONS

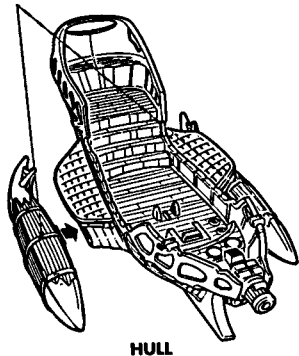

PONTOON INSTALLATION

7. Snap tab on right pontoon into slot in hull as shown. Repeat with left pontoon.

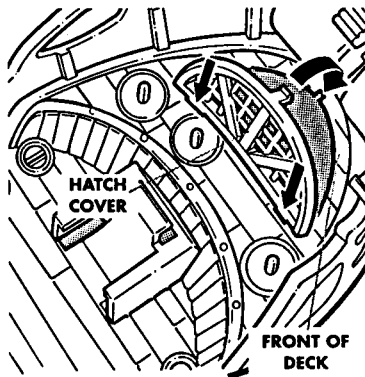

HATCH COVER INSTALLATION

8. Snap hatch cover into opening in front of deck as shown.

STEERING COLUMN HALVES

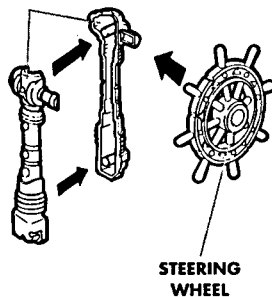

STEERING ASSEMBLY

9. Press both halves of steering column together. Snap steering wheel onto peg at top of steering column.

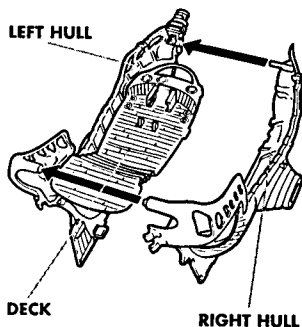

HULL INSTALLATION

4. Align right hull with completed left hull/deck assembly. Press together and snap into place.

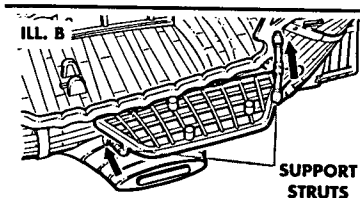
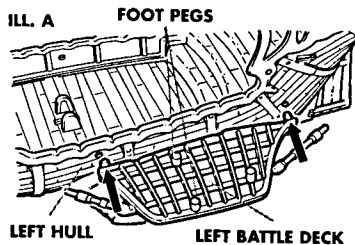

BATTLE DECK INSTALLATION

5. Snap left battle deck into holes on left side of hull as shown (ILL. A). Bend support struts and fit into holes on left side of hull as shown (ILL. B). Repeat with right battle deck.

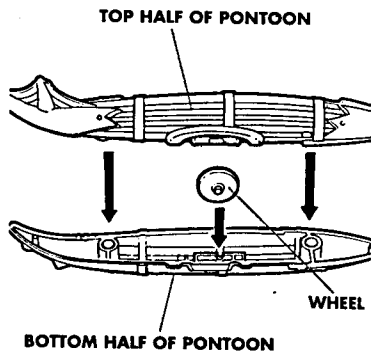

PONTOON ASSEMBLY

6. Fit wheel into hole in bottom pontoon half. Press both pontoon halves together. Repeat with other pontoon.

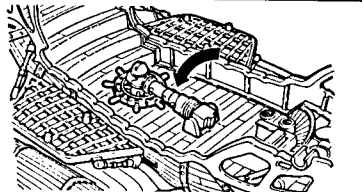
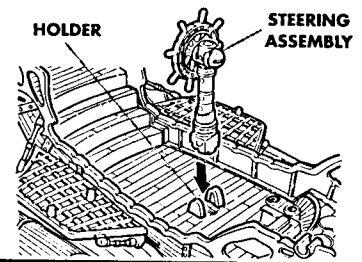

STEERING ASSEMBLY INSTALLATION

10. Snap posts at base of steering assembly into holder located at center of deck. Steering assembly designed to fold down and adjust to figure's reach.

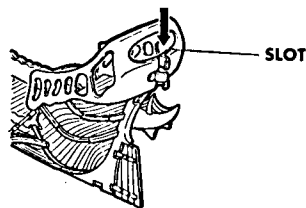
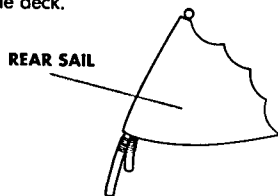

SAIL ASSEMBLY

11. Fit mast of rear sail into slot at back of Dragon Wing.™ Carefully slide the rear (small) sail onto mast.

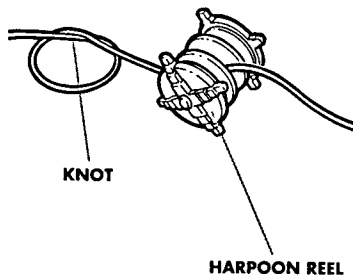

HARPOON REEL ASSEMBLY

12. Thread piece of string (sold separately) through hole in reel and tie a knot in the end.

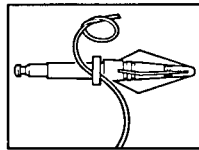
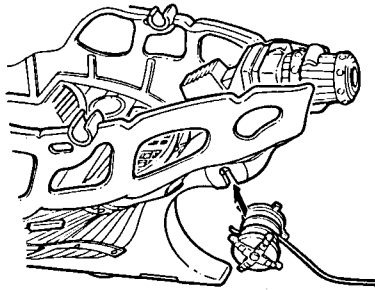

HARPOON

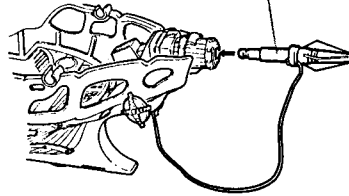

HARPOON REEL ASSEMBLY CONT.
13. Snap reel into slot at front of hull as shown.

SHOOTING HARPOON

14. Thread other end of string through hole in harpoon and tie a knot in the end. Insert harpoon into cannon. Press trigger to fire. **CAUTION: Do not aim weapon at eyes or face.**

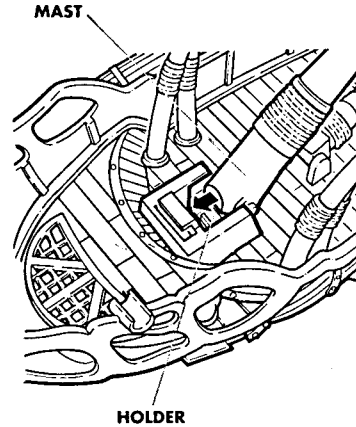

MAST

HOLDER

MAST INSTALLATION

15. Slide base of mast into holder on deck.

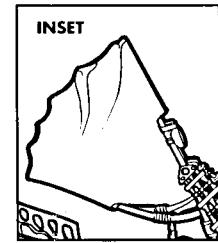

INSET

POSTS

MAST
SAIL

BOOM

MAIN SAIL ASSEMBLY

16. Carefully slide the main (large) sail onto mast and over posts (inset). Fit boom into sail as shown, then snap boom into mast.

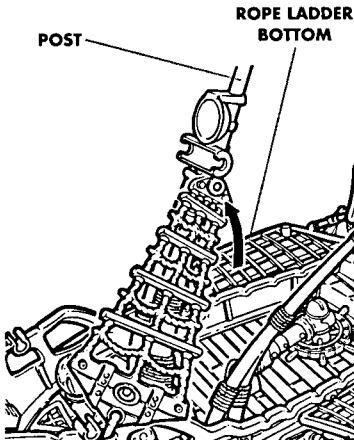

ROPE LADDER
BOTTOM

POST

ROPE LADDER INSTALLATION

17. With sail on mast (not shown) hook bottom of rope ladder into hole on left railing as shown. Fit hole at top of rope ladder over post at top of mast. Repeat with other rope ladder on right railing.

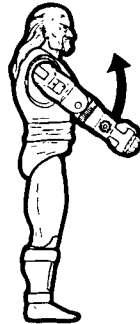
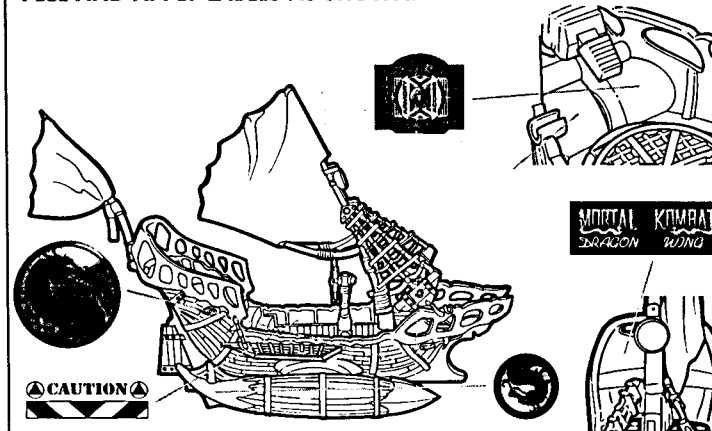

FIGURE INSTRUCTIONS

18. Lift right arm counterclockwise as shown, then hold in place. To activate, release arm.

PEEL AND APPLY LABELS AS SHOWN.



Product and colors may vary.

Approximate size of vehicle is 21" (53 cm) L X 8" (20 cm) W X 12" (30cm) H.

©1994 Hasbro, Inc., Pawtucket, RI 02862 USA. All Rights Reserved.

MADE IN USA. FIGURE MADE IN CHINA. Unauthorized Duplication Is Strictly Prohibited.

©1992 MORTAL KOMBAT™ is a trademark of Midway® Manufacturing Company.

All Rights Reserved. Used Under License.

81348

P/N 4570270