

Age Code:
ed 5 & Up

81336

WARNING:
CHOKING HAZARD - Small parts.
Not for children under 3 years.



CONTAINS: Kombat Cycle with Zipcord, Figure, 2 Missiles, Missile Launching Sidecar, Front Wheel Halves, 2 Rear Wheels, 2 Treads, Rear Wheel Gear, Sidecar Wheel and Label Sheet.

KOMBAT CYCLE™ OFFICIAL VEHICLE SPECIFICATIONS

1. 2 SURFACE-TO-AIR "DRAGON FIRE" MISSILES
2. MISSILE LAUNCHING SIDECAR WITH BIO-SENSITIVE INTERNAL TRACKING DEVICE
3. ZIPCORD ACTIVATES MOTORIZED ACTION
4. AERODYNAMIC WINDSCREEN WITH ANTI-RADAR STEALTH ARMOR
5. SELF-ADJUSTING, ALL-TERRAIN SUPER-SHOCKS
6. PUNCTURE-PROOF KOMBAT CYCLE™ TIRES
7. STEEL-CASED INTERNAL NOISE SUPPRESSOR
8. TITANIUM PLATED, SUPER-STOP DISC BRAKE
9. CUSTOMIZED, COMPUTER ENHANCED DASHBOARD CONTROLS

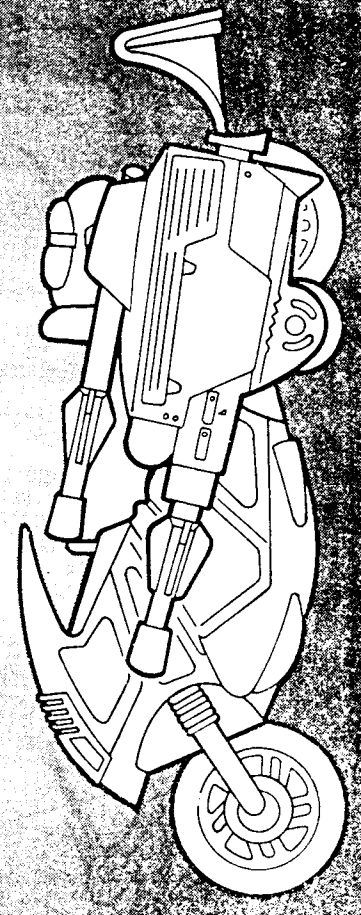

Remove all pieces from plastic frames. If you have difficulty use safety scissors.
CAUTION: Do not point weapon at eyes or face.

Product and colors may vary.
Approximate size of vehicle is 8 1/4" (21 cm) L X 3" (7.5 cm) W X 2 3/4" (7cm) H.
©1994 Hasbro, Inc., Pawtucket, RI 02862 USA. All Rights Reserved.
MADE IN BRAZIL. FIGURE MADE IN CHINA. Unauthorized Duplication Is Strictly Prohibited.
©1992 MORTAL KOMBAT™ is a trademark of Midway Manufacturing Company.
All Rights Reserved Used Under License. P/N 45557901 81336

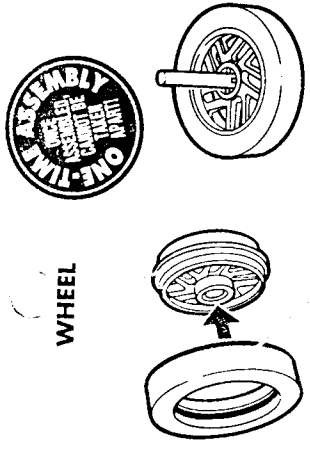

REAR WHEEL ASSEMBLY
 1. Fit treads onto wheels as shown.
NOTE: For a smooth tread surface, it may be necessary to trim excess bumps left by the runner frame from both tire treads.

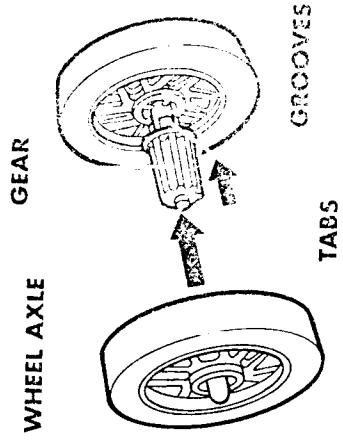

REAR WHEEL ASSEMBLY CONT.
 2. Press gear onto wheel axle while fitting gear tabs into grooves in wheel. Press other wheel onto axle.

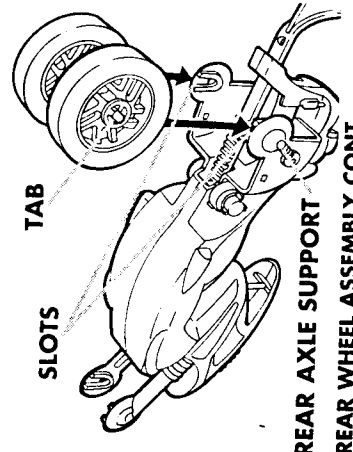

REAR WHEEL ASSEMBLY CONT.
 3. Snap posts on rear wheels into slots inside rear axle support.

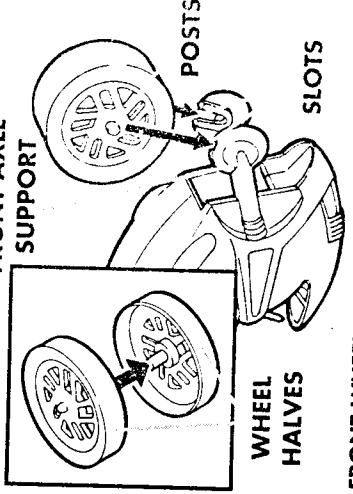

FRONT WHEEL ASSEMBLY
 4. Press front wheel halves together (inset). Snap wheel posts into slots inside front axle support.

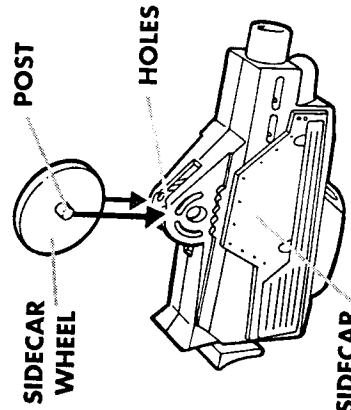

SIDECAR ASSEMBLY
 5. Snap sidecar wheel posts into holes in sidecar.

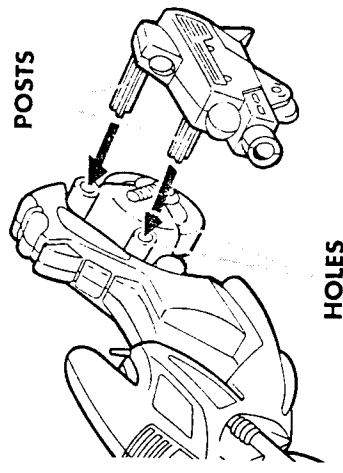

SIDECAR ASSEMBLY CONT.
 6. Press sidecar posts into cycle holes. Sidecar is designed to be removed from cycle.

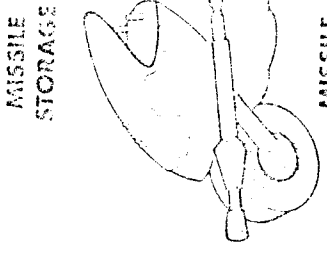

MISSILE FIRING STORAGE
 7. Insert missile into sidecar barrel as shown. To fire, press trigger at rear of sidecar. Other missile can be stored in top of sidecar as shown.
CAUTION: DO NOT AIM WEAPON AT EYES OR FACE.

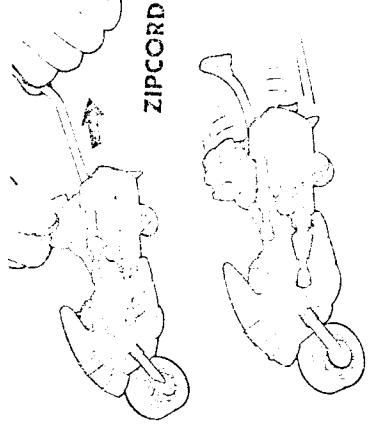
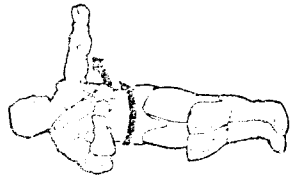

ACTIVATING CYCLE
 8. Pull back zipcord, then press down slightly on rear of cycle to hold cycle in place (inset). Release zipcord and cycle for fast attacks! **NOTE:** For best results, use the Kombat Cycle on a hard, flat surface.

FIGURE INSTRUCTIONS

1. Lift either arm and twist body as shown.
2. Release to activate.

