

MONSTER FACE

Remove all pieces from plastic frames. If you have difficulty, use safety scissors. Remove pieces from plastic bags, then discard bags immediately.

INSTRUCTIONS

Includes: base, neck assembly, eye frame, 2 creepy controls, sculpting scalpel, eye link, eye lever, 2 screws, head door, skull, skull cap, jaw, Monster Glop™, red and green MOULDing clay, mohawk hairpiece, fuzzy hairpiece, 2 cat eyes, 2 human eyes, hawk nose, scar nose, human teeth, fangs, 2 pointed ears, 2 fat ears, 2 eye extenders, tongue, 3 hair clips, 2 blisters, bellows, hose, 3 worms, 3 spiders, 2 eyeballs, label sheet and instruction sheet.

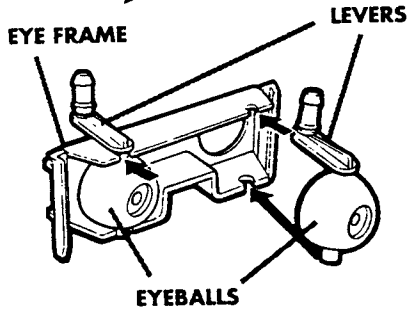

EYEBALL ASSEMBLY

1. Snap eyeballs into eye frame as shown. Make sure levers are facing up.

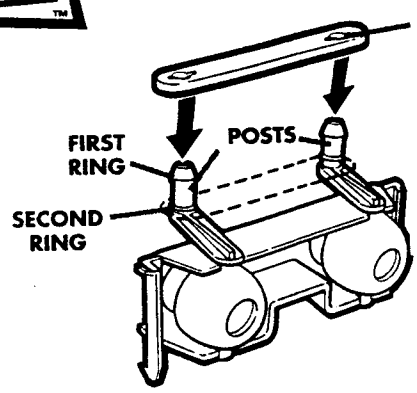

EYE CONNECTOR ASSEMBLY

2. Press posts at end of eyeball levers through holes at either end of connector as shown. Slide connector all the way down the posts until it snaps into place underneath the second ring as shown.

HOW TO ATTACH EYEBALL ASSEMBLY TO SKULL

3. Slide eye frame into skull cavity until hooked posts protrude through holes in base of skull as shown. Press forward on eye frame until it snaps into place.

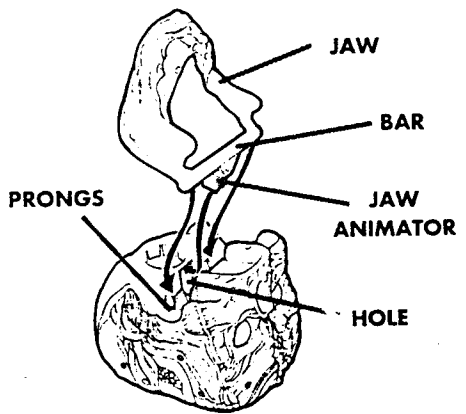

JAW ASSEMBLY

4. Insert jaw animator through hole in base of skull, then snap bar at back of jaw into prongs at base of skull.

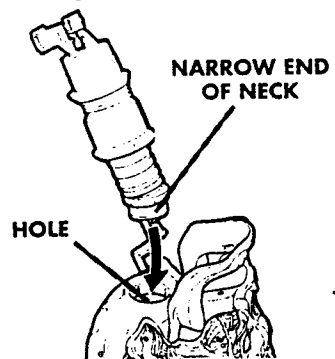

NECK ASSEMBLY

5. Snap narrow end of neck through hole at base of skull as shown.

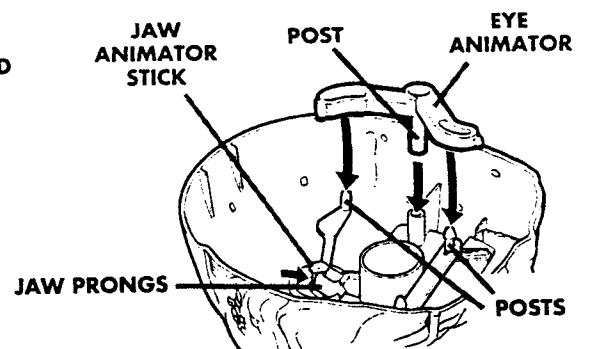

NECK & EYE ANIMATOR ASSEMBLY

6. Snap jaw animator stick into jaw prongs as shown. Insert post at center of eye animator into tube in skull cavity while fitting openings at either end of eye animator over posts as shown.

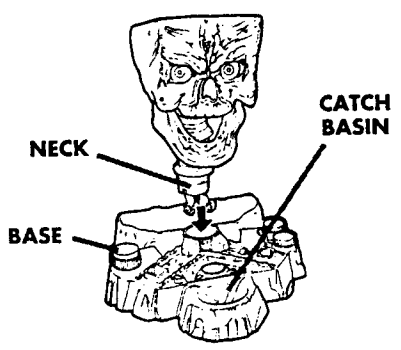

HOW TO ATTACH NECK TO BASE

7. Snap bottom of neck into opening on base. Front of skull should be directly over Monster Glop™ catch basin.

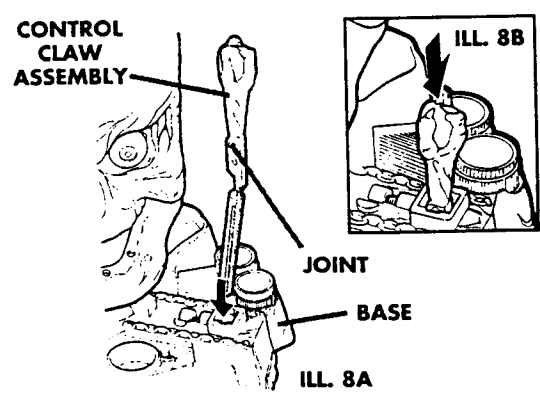

HOW TO ASSEMBLE CONTROL CLAW

8. Guide one control claw assembly through hole on right side of catch basin (ILL. 8A). Snap joint on control claw into base as shown (ILL. 8B). Turn Monster Face upside down and insert end of control claw post into bracket as shown (ILL. 8C). Repeat with remaining control claw.

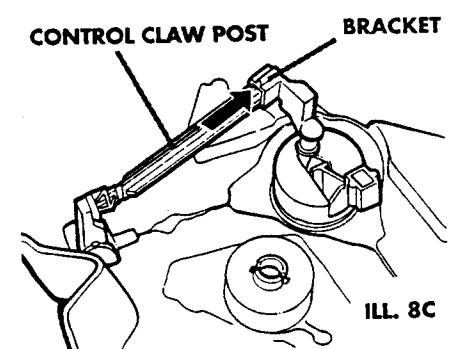

ILL. 8C

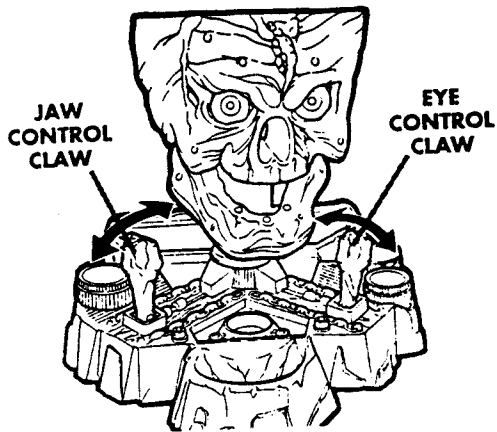

HOW TO OPERATE CONTROL CLAW

9. To shift eyes, move eye control claw forwards and backwards. To open and close jaw, move jaw control claw forwards and backwards.

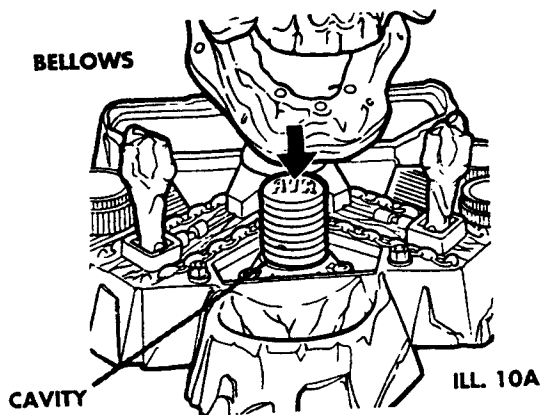

HOW TO ASSEMBLE THE BLISTER

10. Insert the bellows into cavity on base located under Monster Face's jaw (ILL. 10A). While holding bellows in place, turn Monster Face upside down. Twist nozzle on bellows as shown (ILL. 10B).

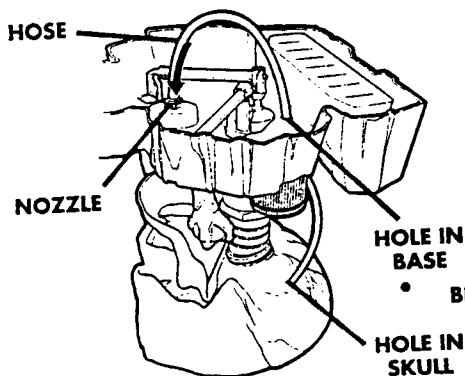
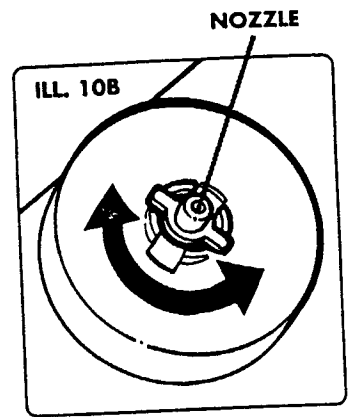

11. Press one end of hose over bellows nozzle. Make sure it is firmly attached. Run loose end of hose through hole in base (next to neck), then insert it through hole in skull as shown. Loose end of hose should end up *inside* of Monster Face's skull.

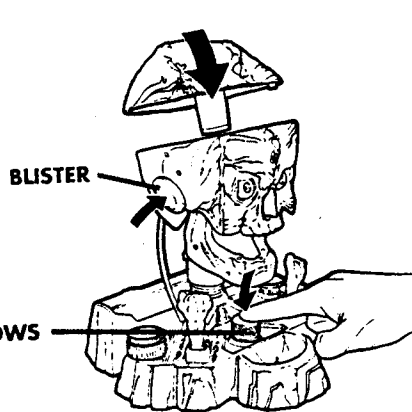

12. Insert peg on blister into any open hole in Monster Face's skull. Press loose end of hose over peg on blister. Assemble top half of skull as shown. Simply pump the bellows to inflate the blister! Note: Monster Face comes with a spare blister.

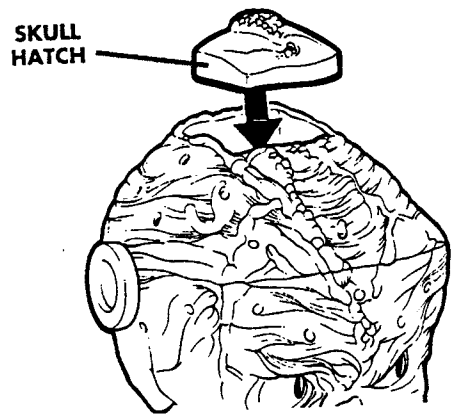

13. Skull hatch fits over opening in top half of skull as shown.

NOW THAT THE SKULL IS ASSEMBLED, IT'S TIME TO CREATE YOUR VERY OWN MONSTER FACE! Use these directions as a guide only. Remember . . . *you* are the ultimate creator . . . **NOTE: ALL PEGGED FACIAL ACCESSORIES MAY FIT ANYWHERE YOU FIND A HOLE!**

Monster Face comes with two pairs of cat-style eyes and human-style eyes. Mix 'em or match 'em . . . for thoroughly frightful results!

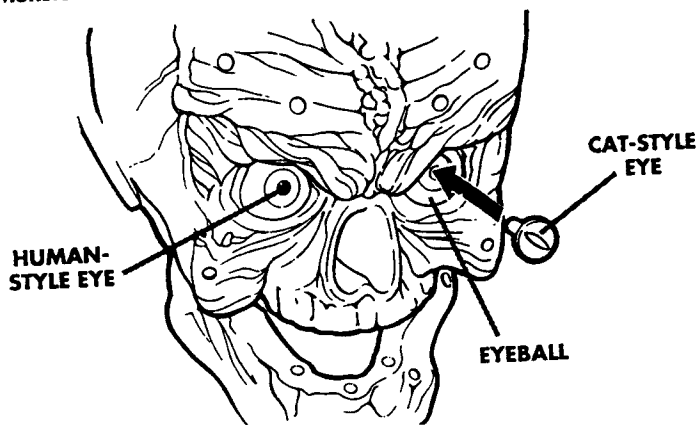

HOW TO INSTALL AND REMOVE EYES

Press peg on eye into hole in eyeball. Repeat step with other eyeball and eye. To replace eye, remove top of Monster Face's skull. Insert finger into back of eyeball and push peg on eye until it pops out. Repeat with other eyeball if desired. Then insert new eye.

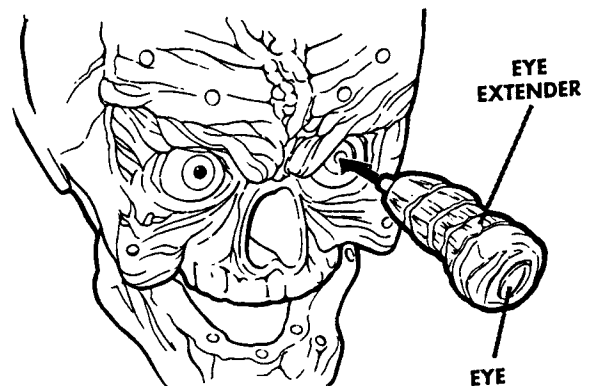

HOW TO INSTALL EYE EXTENDERS

Remove eye from eyeball. Press peg on eye extender into hole in eyeball. Insert eye into eye extender. Repeat steps with other eye extender. To remove eye extender, simply pull it out of eyeball. Eye pulls out of eye extender.

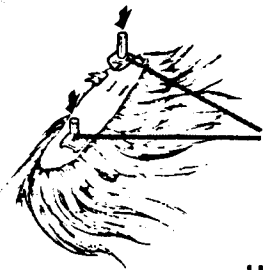

Press hair clip(s) into base of hair piece as shown.

HAIR PIECES

Use one or both of the hair pieces to top off your revolting creation! Insert hair clip peg(s) into hole(s) in skull.

HOW TO INSTALL EARS

Pegs on ears fit into holes on skull as shown. Use either set of ears for a disgusting effect.

MAD MOULDING CLAY

For added detail, use the sculpting scalpel or your hands to apply the Mad MOULDing Clay. Create festering pustules, oozing sores, blistering welts, gaping wounds, writhing maggot mounds and much, much more! Best of all, Mad MOULDing Clay doesn't dry out!

Suggestion: common household utensils such as rolling pins or cookie cutters may be used to shape and design your clay creations!

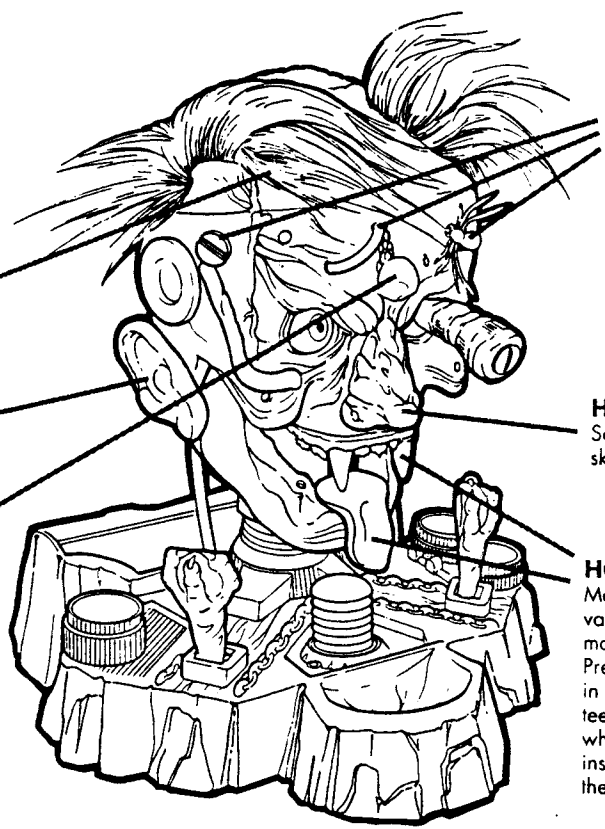

HOW TO INSTALL VARIOUS CREEPY ACCESSORIES

To add those final touches that make Monster Face a memorably madcap monster, position bugs, worms and screws wherever you please!

HOW TO INSTALL NOSES

Select a nose and insert peg into hole on skull as shown.

HOW TO INSTALL TEETH & TONGUE

Monster Face comes with two sets of choppers: vampire fangs and human teeth. Mix 'em or match 'em . . . for thoroughly 'biteful' results! Press pegs on upper fangs (or teeth) into holes in upper jaw. Repeat step with lower fangs (or teeth) in lower jaw. Tongue will not fit on jaw when lower fangs (or teeth) are in place. To install tongue, press peg on tongue into one of the three holes in bottom jaw as shown.

PEEL AND APPLY LABELS AS SHOWN.

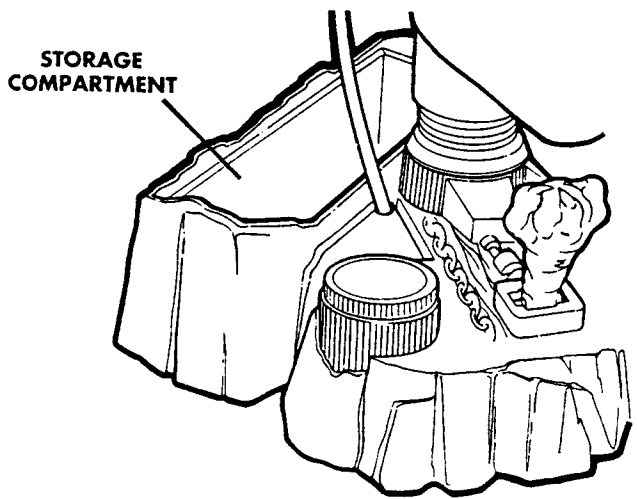
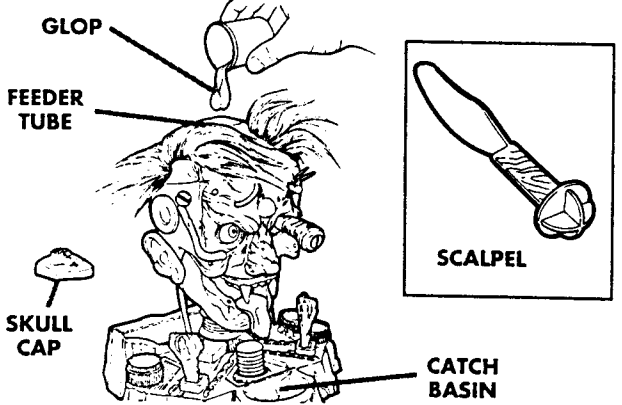
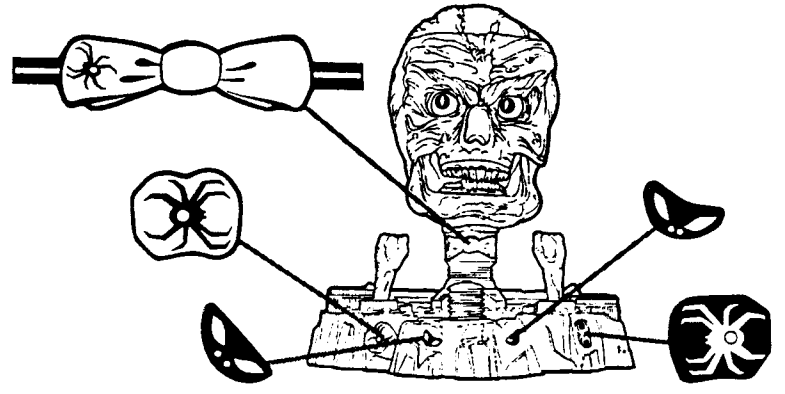
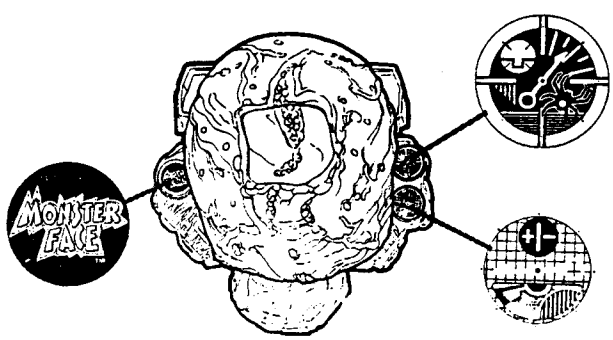

MONSTER GLOP™

Pour Monster Glop into Glop Feeder Tube and watch it ooze from Monster Face's nose into the handy catch basin! To accelerate the dripping action, use the sculpting scalpel handle as a convenient plunger. Note: make sure Monster Face's nose cavity is clear of Monster Glop to prevent future clogging. Use sculpting scalpel to scrape out Monster Glop residue. When finished using Monster Glop, return it to container and close lid.

STORAGE COMPARTMENT

Facial components and accessories may be stored in the handy compartment located at rear of base.

HOW TO MAKE A FESTERING BLISTER

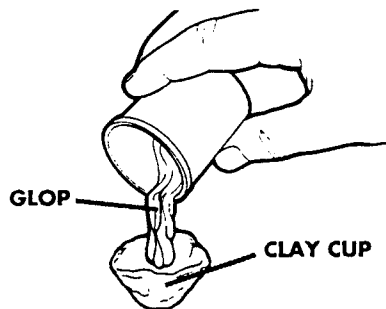

1. Mold clay into a cup shape as shown. Half fill cup with glop.

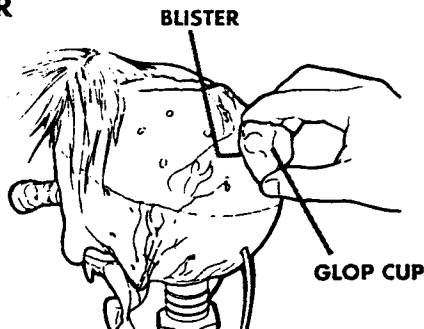

2. Quickly press "glop cup" concoction over blister on skull as shown. Use fingers to smooth edges of clay onto skull to make "glop cup" adhere.

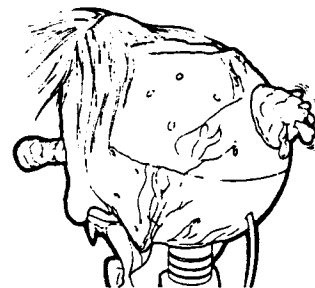

3. Pump bellows to inflate blister . . . glop will burst through layer of clay! YUCK!

HOW TO MAKE STITCHES

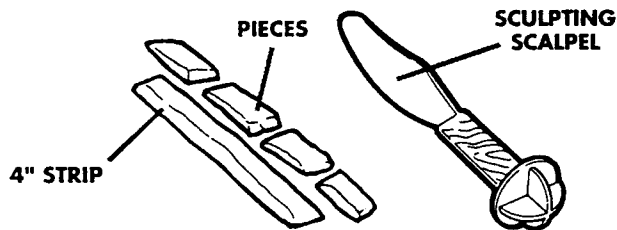

1. Roll clay into thin layer. Use sculpting scalpel to cut 2 thin strips about 1/4 inch wide by 4 inches long. Cut the remaining strip into four pieces as shown.

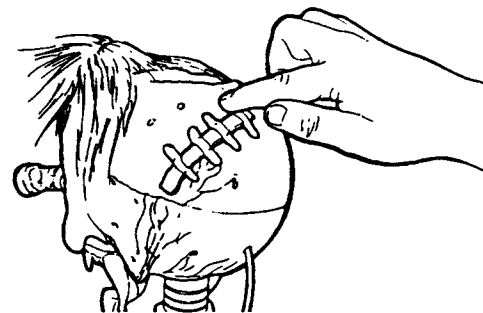

2. Press one of the 4 inch strips onto Monster Face's skull. Apply 4 remaining clay strips as shown. Voila . . . STITCHES!

IMPORTANT REMINDER:
WHEN CREATING MONSTER FACE™ DON'T BE AFRAID TO USE YOUR IMAGINATION!

A SPECIAL NOTE ABOUT Monster Glop™ AND MOULDING CLAY: Monster Glop may require kneading to achieve proper consistency. It must be stored in its own can to prevent drying. Monster Glop may stick to rugs, fabrics, hair, and may damage wood surfaces. If staining occurs, clean with cold water and laundry detergent. Remember to replace lid when not in use.

MOULDING clay may stain certain fabrics. Take precautions to keep MOULDING clay away from fabrics and carpets. Product and colors may vary.

©1992 Hasbro, Inc., Pawtucket, RI 02862 USA. All Rights Reserved. Distributed in the U.K. by Hasbro U.K. Limited, Caswell Way, Newport, Gwent NP9 OYH.
©denotes Reg. U.S. Pat. & TM Office. Polybagged facial accessories made in China, remainder made in USA.
7955 P/N 42982100