

MONSTER HEAD MAKER™

INSTRUCTIONS

WARNING:
CHOKING HAZARD-Small parts.
Not for children under 3 years.

Assembly required.
No tools necessary.

Thank you for purchasing this ghoulishly great Goosebumps toy, which we think is a head above the rest! For maximum enjoyment of this product, be sure to follow all instructions carefully. If you have any questions, comments, or need additional information concerning this product or its parts, please call our Hasbro Consumer Service hotline at 1-800-327-8264, Monday through Friday, 8:00 AM to 5:00 PM Eastern Time.

Remove all pieces from plastic frames. If you have difficulty, use safety scissors. Remove pieces from plastic bags, then discard bags immediately.

LET'S MAKE A MONSTER!

With this set, you can recreate 4 characters inspired by your favorite Goosebumps books:

- The Haunted Mask (#11)
- Curse of the Mummy's Tomb (#5)
- Stay Out of the Basement (#2)
- The Girl Who Cried Monster (#8)

INCLUDES BUG-OUT BLUE EYES, BEADY EYES, EERIE EYE EXTENDERS, MOHAWK HAIR, CURLY HAIR, POINTY EARS, GROSS-OUT EARS, MODELING CLAY, SCULPTING SCALPEL, YUCKY TONGUE, ROTTEN TEETH, FREAKY FANGS, WIGGLY WORMS, ICKY ANTS, UGLY BUGS, SCAR NOSE, GROSS NOSE, MONSTER HEAD MAKER OOZE CATCH BASIN, STORAGE CHAMBER, PULSATING BOIL, HAIR CLIPS, BELLOWS/HOSE ASSEMBLY, CREEPY EYE & MOUTH CONTROL CLAWS, MUMMY WRAP (3 FT.), MONSTER HEAD MAKER OOZE.

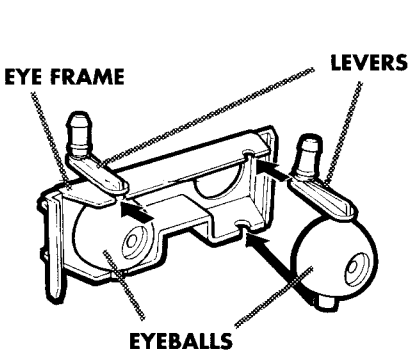

EYEBALL ASSEMBLY

1. Snap eyeballs into eye frame. Make sure levers are facing up as shown.

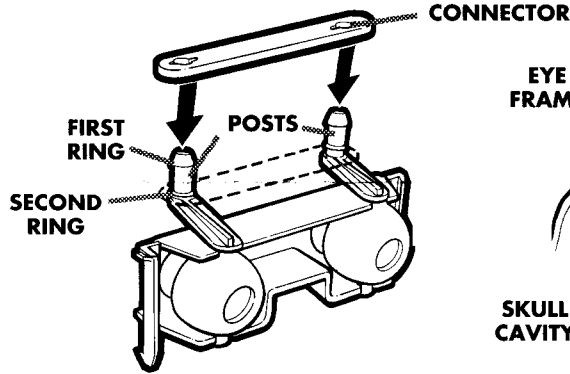

EYE CONNECTOR ASSEMBLY

2. Press posts at end of eyeball levers through holes at either end of connector. Slide connector all the way down the posts until it snaps into place underneath the second ring as shown.

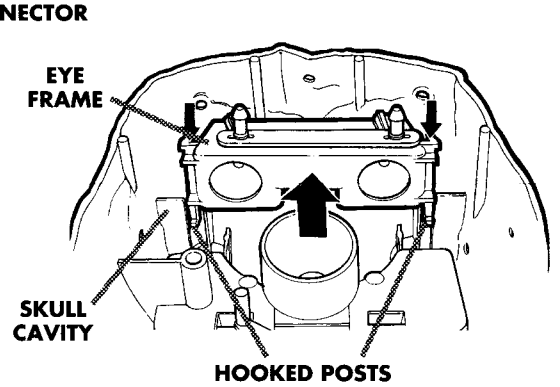

HOW TO ATTACH EYEBALL ASSEMBLY TO SKULL

3. Slide eye frame into skull cavity until hooked posts protrude through holes in base of skull as shown. Press forward on eye frame until it snaps into place.

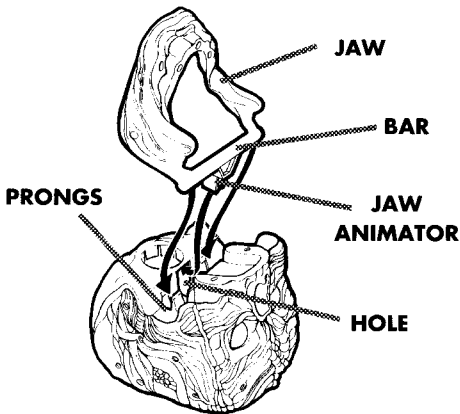

JAW ASSEMBLY

4. Insert jaw animator through hole in base of skull, then snap bar at back of jaw into prongs at base of skull.

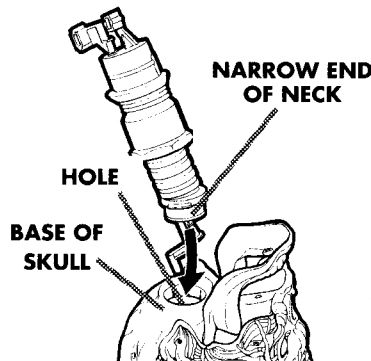

NECK ASSEMBLY

5. Snap narrow end of neck through hole at base of skull as shown.

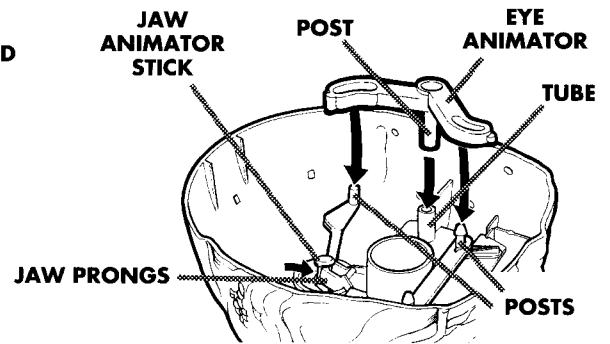

NECK ANIMATOR ASSEMBLY

6. Snap jaw animator stick into jaw prongs as shown. Snap into place. Insert post at center of eye animator into tube in skull cavity while fitting openings at either end of eye animator over posts as shown.

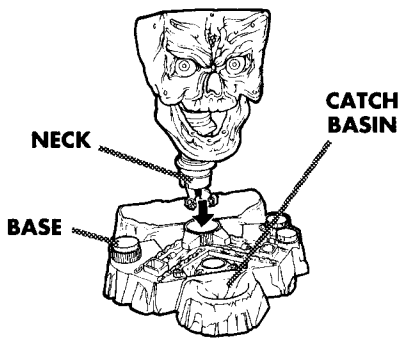

HOW TO ATTACH NECK TO BASE

7. Snap bottom of neck into opening on base. Front of skull should be directly over ooze catch basin.

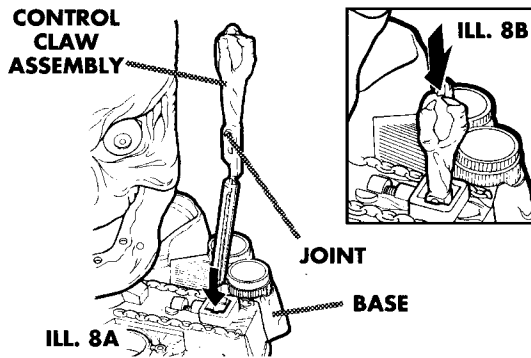

ILL. 8A

HOW TO ASSEMBLE CONTROL CLAW

8. Guide one control claw assembly through hole on right side of catch basin (ILL. 8A). Snap joint on control claw into base as shown (ILL. 8B). Turn Monster Head upside down insert end of control claw post into bracket as shown. Repeat with remaining control claw (ILL. 8C).

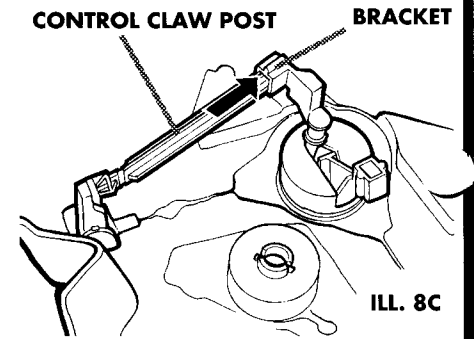

ILL. 8C

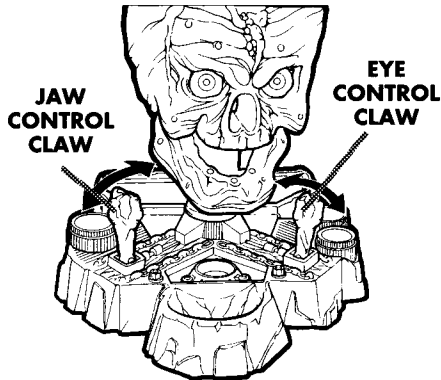

HOW TO OPERATE CONTROL CLAW

9. To shift eyes, move eye control claw forwards and backwards. To open and close jaw, move jaw control claw forwards and backwards.

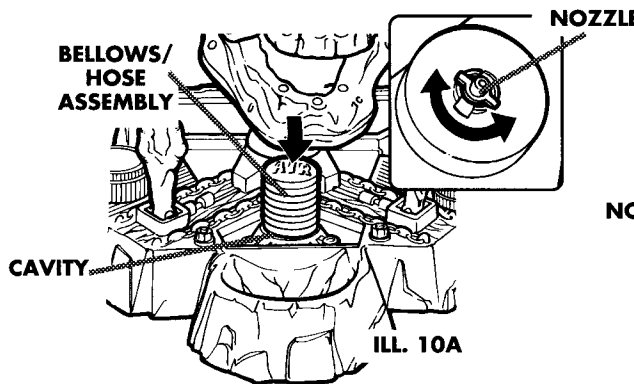

ILL. 10A

HOW TO ASSEMBLE THE BOIL

10. Insert bellows/hose assembly into cavity on base located under Monster Head's jaw. While holding bellows in place, turn Monster Head upside down. Twist nozzle on bellows until it locks into place as shown.

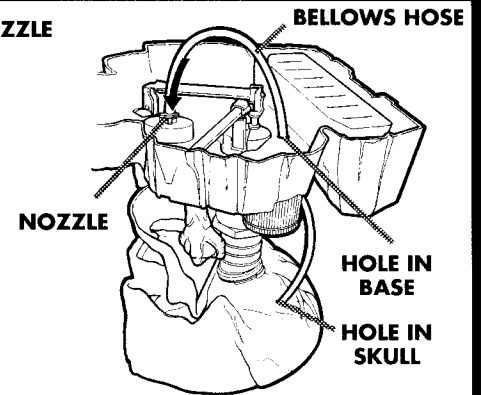

11. Run loose end of bellows hose through hole in base (next to neck), then insert it through hole in skull as shown. Loose end of hose should end up inside of Monster Head's skull.

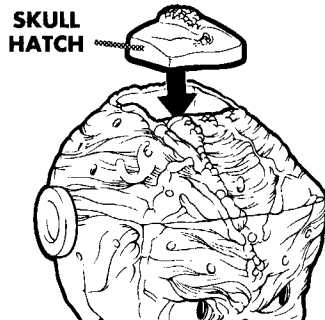
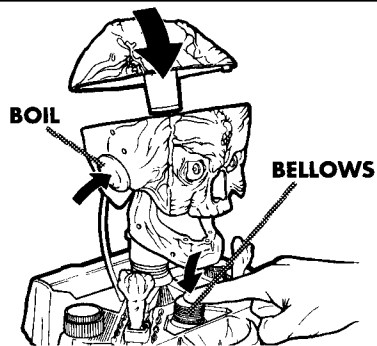

SKULL HATCH

HOW TO MAKE THE BOIL PULSATE

12. Insert peg on boil into any open hole in Monster Head's skull. Press loose end of hose over peg on boil. Assemble top half of skull as shown. Simply pump the bellows to inflate the boil! Attach skull hatch as shown. Note: Monster Head Maker comes with a spare boil.

NOW THAT THE SKULL IS ASSEMBLED, IT'S TIME TO CREATE YOUR VERY OWN MONSTER FACE! Use these directions as a guide only. Remember . . . you are the ultimate creator . . . **NOTE: ALL PEGGED FACIAL ACCESSORIES MAY FIT ANYWHERE YOU FIND A HOLE!**

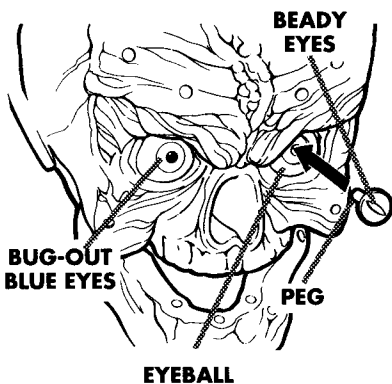

EYEBALL

HOW TO INSTALL AND REMOVE EYES

Monster Head Maker comes with two pairs of eyes: bug-out blue eyes and beady eyes. Mix 'em or match 'em...for thoroughly frightful results! Press peg on eyes into hole in eyeball. Repeat step with other eyeball and eye. To replace eye, remove top of the monster's skull. Insert finger into back of eyeball and push peg on eye until it pops out. Repeat with other eyeball if desired. Then insert new eye, if desired.

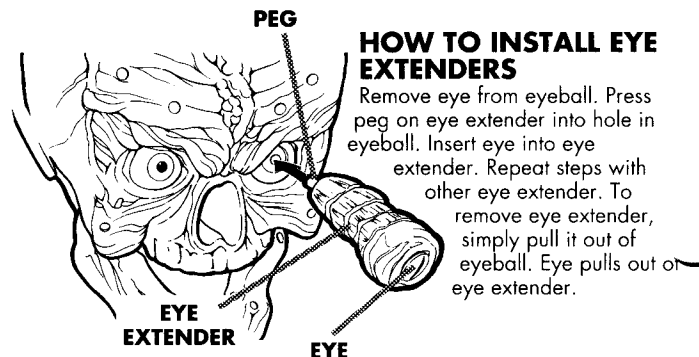

HOW TO INSTALL EYE EXTENDERS

Remove eye from eyeball. Press peg on eye extender into hole in eyeball. Insert eye into eye extender. Repeat steps with other eye extender. To remove eye extender, simply pull it out of eyeball. Eye pulls out of eye extender.

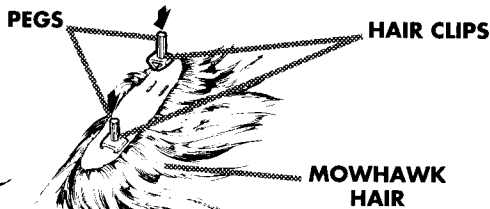

HAIR PIECES

Use one or both of the hairpieces to top off your scare-i-fying creation! Press hair clip(s) into base of hairpiece as shown. Insert hair clip peg(s) into hole(s) in skull..

HOW TO INSTALL EARS

Pegs on ears fit into holes on skull as shown. Use either set of ears for a thoroughly disgusting effect.



HOW TO INSTALL VARIOUS CREEPY ACCESSORIES

To add that extra-special touch to your creation, position bugs, ants, worms and wherever you please!

HOW TO INSTALL NOSES

Select a nose and insert peg into hole on skull as shown.

HOW TO INSTALL TEETH & TONGUE

Monster Head Maker comes with two sets of choppers: freaky fangs and rotten teeth. Mix 'em or match 'em...for thoroughly 'bitiful' results! Press pegs on upper fangs (or teeth) into holes in upper jaw. Repeat step with lower fangs (or teeth) in lower jaw. Tongue will not fit on jaw when lower fangs (or teeth) are in place. To install tongue, press peg on tongue into one of the three holes in bottom jaw as shown.

GIVE YOUR MONSTER AN IDENTITY... WITH THE MODELING CLAY

Now that you know how to use the facial accessories, it's time to create a favorite Goosebumps monster! For a scare beyond compare, you can make:



• The Haunted Mask
(The Haunted Mask - #11)



• Librarian
(The Girl Who Cried Monster - #8)



• Ancient Mummy
(Curse of the Mummy's Tomb - #5)



• Creature From the Basement
(Stay Out of the Basement - #2)

(For additional detail and color, refer to the photos on the back of the package!)

Use the sculpting scalpel or your hands to apply the modeling clay. Create ghoulishly great monsters complete with blisters, welts, maggot mounds and much, much more! Best of all, the modeling clay doesn't dry out!

Suggestion: common household utensils such as rolling pins or cookie cutters may be used to shape and design your clay creations!

LET'S WRAP! Use the mummy wrap to make your own Ancient Mummy! To begin, affix one end of the wrap to the monster's head with a dab of modeling clay. Then, wrap the head to mummify your monster! Tuck remaining end back inside wrap. Well, that about covers it!

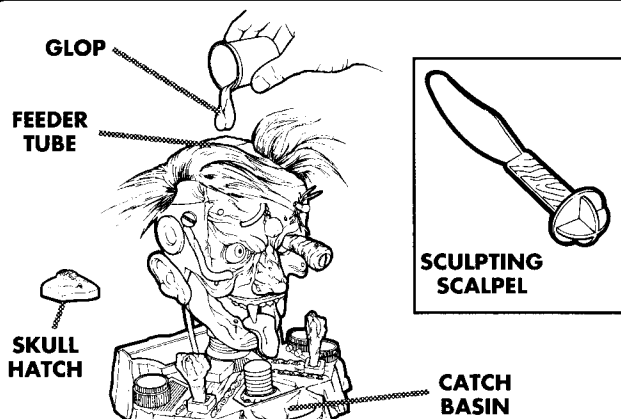

MONSTER HEAD MAKER OOZE

Remove skull hatch. Pour Monster Head Maker Ooze into Feeder Tube and watch it drip from the monster's nose into the handy catch basin! To accelerate the dripping action, use the sculpting scalpel handle as a convenient plunger. Note: make sure the nose cavity is clear of Monster Head Maker Ooze to prevent future clogging. Use sculpting scalpel to scrape out ooze residue. When finished using Monster Head Maker Ooze, return it to container and close lid.

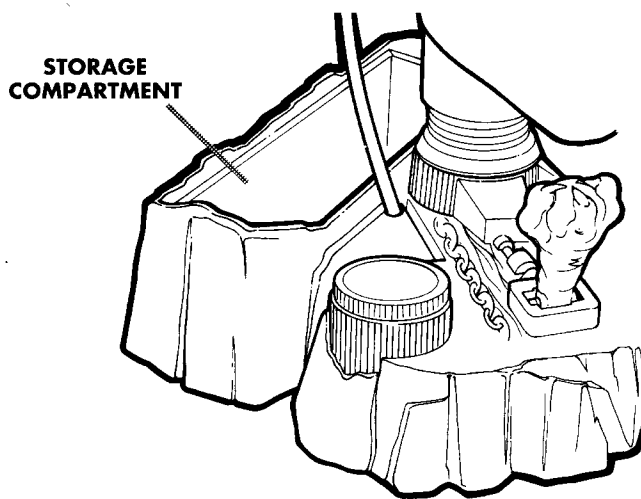

STORAGE COMPARTMENT

Facial components and accessories may be stored in the handy compartment located at rear of base.

PEEL AND APPLY LABELS AS SHOWN.

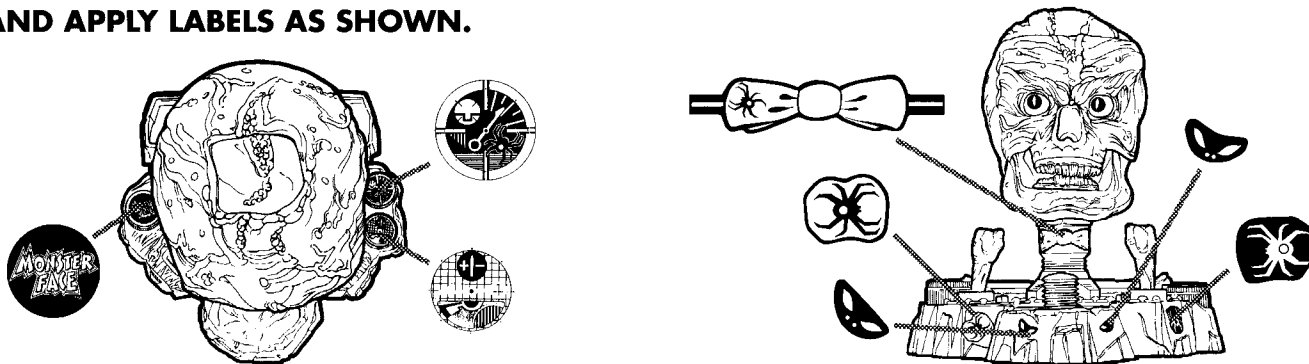

HOW TO MAKE A FESTERING BLISTER

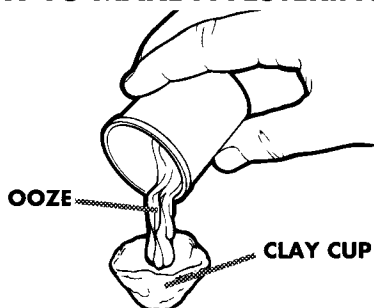

1. Mold clay into a cup shape as shown.
2. Half fill cup with Monster Head Maker Ooze.

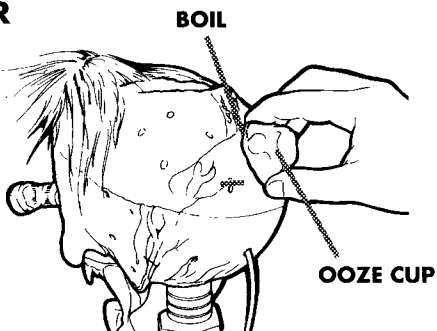

3. Quickly press "ooze cup" concoction over boil on skull as shown. Use fingers to smooth edges of clay onto skull to make "ooze cup" adhere.

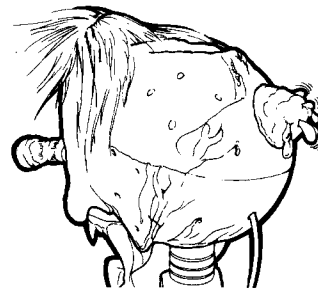

4. Pump bellows to inflate boil . . . ooze will burst through layer of clay! YUCK!

HOW TO MAKE STITCHES

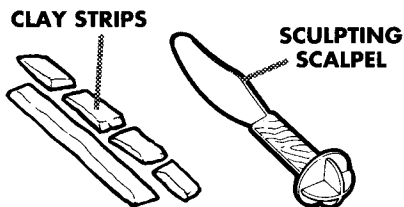

1. Roll clay into thin layer. Use sculpting scalpel to cut 2 thin strips about 1/2 in. wide by 4 in. long.
2. Press one of the 4 in. strips onto monster's skull. Cut the remaining strip into four pieces as shown.

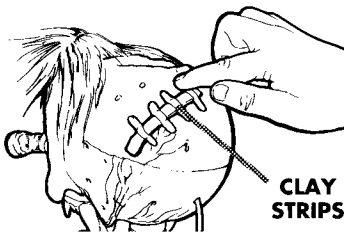

3. Apply 4 remaining clay strips as shown. Voila . . . STITCHES!

**IMPORTANT REMINDER:
WHEN CREATING A MONSTER, DON'T BE
AFRAID TO USE YOUR IMAGINATION!**

A SPECIAL NOTE ABOUT MONSTER HEAD MAKER OOZE AND MODELING CLAY:

Monster Head Maker Ooze may require kneading to achieve proper consistency. It must be stored in its own can to prevent drying. Ooze may stick to rugs, fabrics, hair, and may damage wood surfaces. If staining occurs, clean with cold water and laundry detergent. Remember to replace lid when not in use.

Modeling clay may stain certain fabrics. Take precautions to keep Modeling clay away from fabrics and carpets.

Conforms to ASTM D-4236

™ & © 1996 Parachute Press, Inc. GOOSEBUMPS is a trademark of Parachute Press, Inc. All rights reserved.

© 1996 Hasbro, Inc., Pawtucket, Rhode Island 02862 USA. All Rights Reserved. ® denotes Reg. U.S. Pat. & TM Office.

ASSEMBLED IN MEXICO OF U.S. AND CHINESE COMPONENTS.

22946 P/N 47136700