

AGES 8+

52589

Super Soaker
Don't Get Wet...GET SOAKED!

Monster Rocket™

**Thank you for purchasing the SUPER SOAKER®
MONSTER ROCKET - the 7 Foot gigantic
inflatable rocket that soars over 100 feet
into the sky!**

Don't Get Wet...GET SOAKED!™

⚠ WARNING :

To Avoid Injury: Stay away from rocket when pumping and launching. Do not launch rocket if balloon is not fully inflated, damaged or missing. Use only in wide open grassy areas. Continuous adult supervision required.

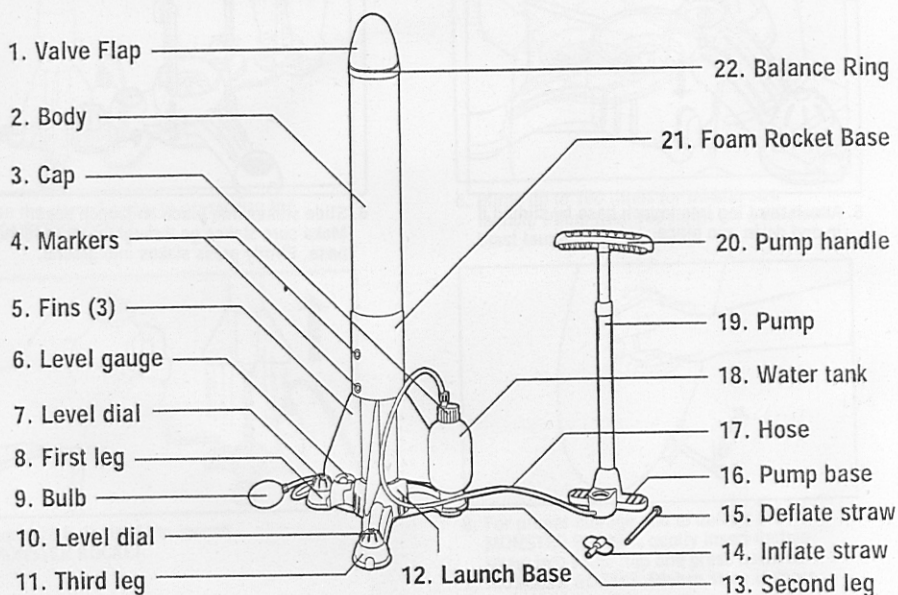

TO ASSEMBLE:

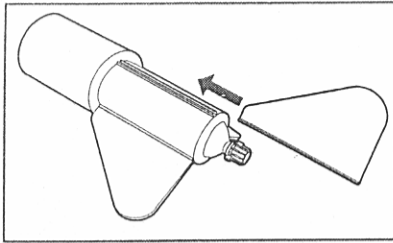

1. Attach the three fins to the foam base by sliding the end of the fins into the plastic "gutter" until they lock into place.

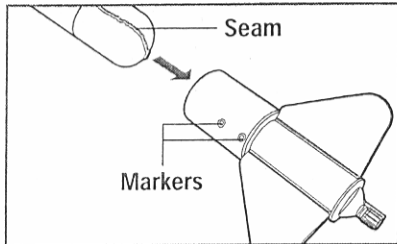

3. Fully insert MONSTER ROCKET body into foam rocket base. Make sure the seams do not line up with the markers, or the rocket will not function properly. Continue to inflate the MONSTER ROCKET with the straw until the body is firm and fully inflated. Remove the straw when finished.

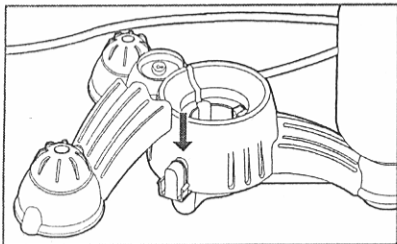

5. Attach third leg into launch base by sliding it in and down into place.

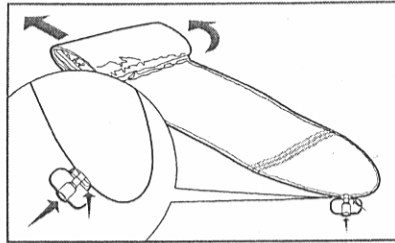

2. Unroll body of MONSTER ROCKET. Gently insert inflate straw into valve flap. Inflate MONSTER ROCKET halfway by blowing into straw.

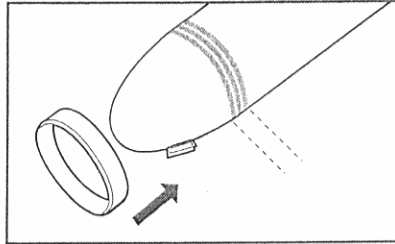

4. Securely place balance ring over top of MONSTER ROCKET, approximately 10 inches from top of MONSTER ROCKET, for optimum balance.

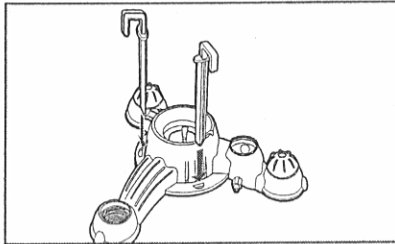

6. Slide stakes into place on launch base. Make sure stakes go through holes in launch base. Firmly press stakes into ground.

TO USE:

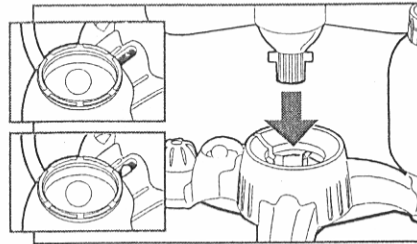

1. Attach MONSTER ROCKET body to launch base by snapping it into place. A pin will appear in the lock indicator when the base is locked. Pull the entire MONSTER ROCKET up to ensure it is properly assembled.

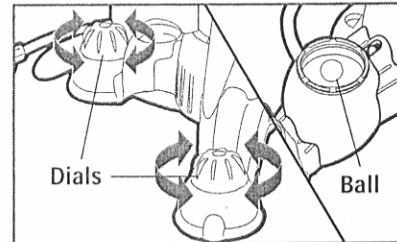

3. Turn both level dials clockwise or counterclockwise to properly level the MONSTER ROCKET launch base. Adjust dials until ball has settled in the center hole.

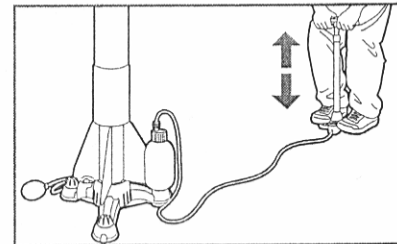

5. Use the pump handle to pressurize the MONSTER ROCKET.

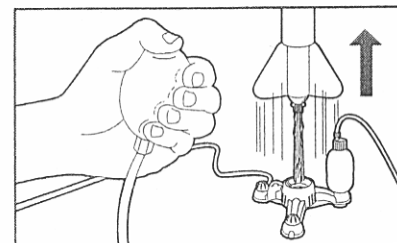

7. Squeeze bulb firmly to launch MONSTER ROCKET.

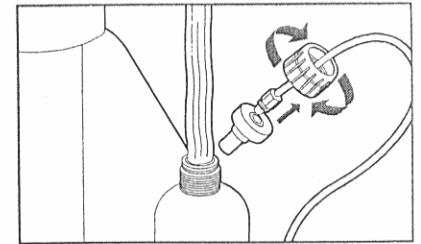

2. Unscrew cap on water tank and fill tank until full with clean, clear tap water. Screw cap counterclockwise on water tank when finished.

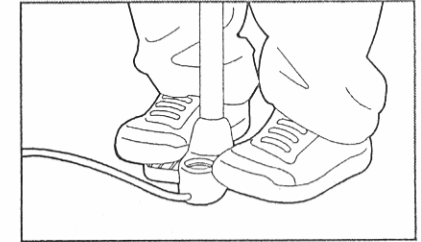

4. Place both feet firmly on the pump base.

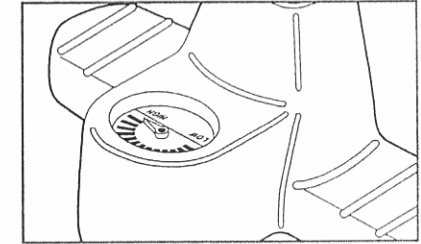

6. Pump up to 100 times for middle size launch. Pump over 100 times for maximum blast launch.

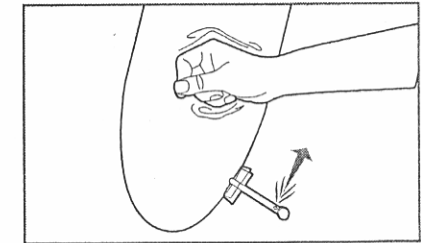

8. For proper storage and to deflate the MONSTER ROCKET, gently insert deflate straw into valve flap and press down on MONSTER ROCKET. Please store indoors.

TROUBLESHOOTING GUIDE:

IF THE MONSTER ROCKET WILL NOT LAUNCH:

First, turn the cap on the water tank once clockwise to release the pressure.

- 1) Make sure the seams on the body are not lined up with the two markers on each side of the foam base.
- 2) Make sure the MONSTER ROCKET body is fully inflated.
- 3) Make sure the MONSTER ROCKET body is fully inserted into the launch base.
- 4) Make sure the metal ball on the level guage has settled in the center hole.

For replacement parts or questions, please call 1-800-327-8264 or log on to www.supersoaker.com.



© 2003 Hasbro. All Rights Reserved.
® denotes Reg. U.S. Pat. & TM Office.
Patent Pending
52589 P/N 6311540000

SUPERSOAKER.COM
FOR NEW PRODUCTS AND OFFERS
Questions? Call 1-800-327-8264