

4. Turn shoppe so that the front faces you. With billboard front facing you, snap bottom edge of billboard between tabs on roof.

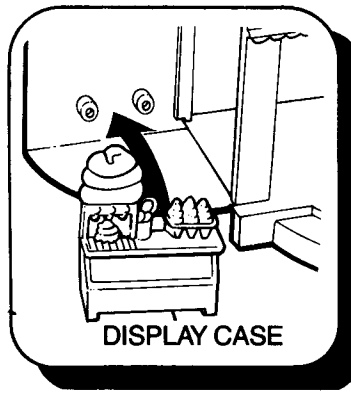

5. Press ice cream display case onto wall.



6. Press counter/cash register onto wall.

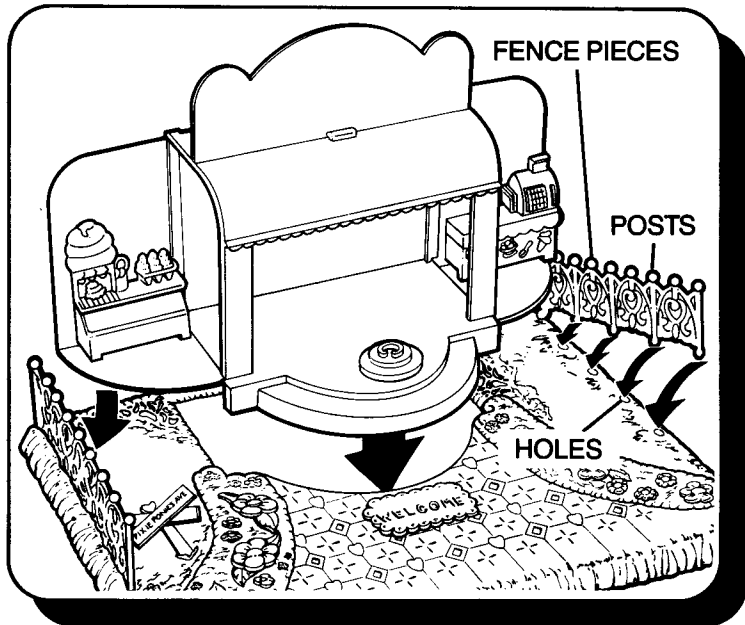

7. Place assembled shoppe on playbase. Insert posts on fence pieces into holes in playbase.

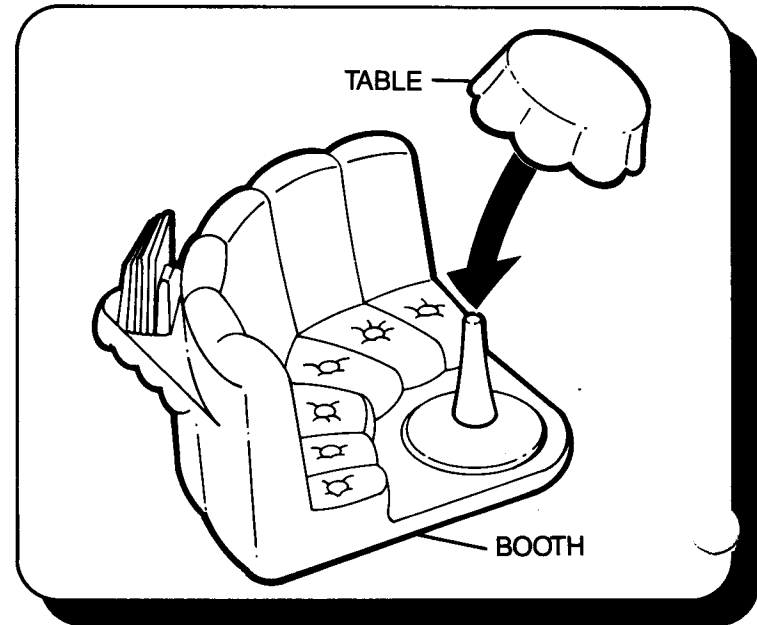

8. Press table over post in booth.

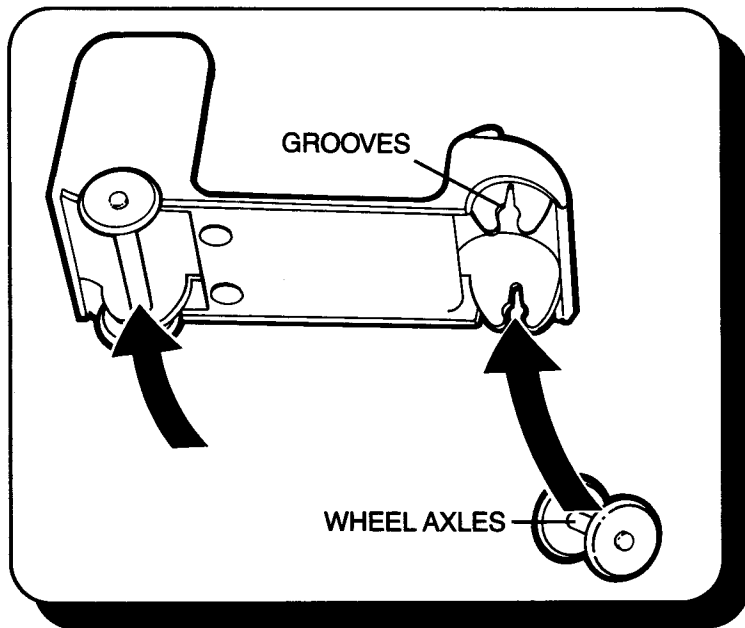

9. Snap wheel axles into grooves in truck bottom.

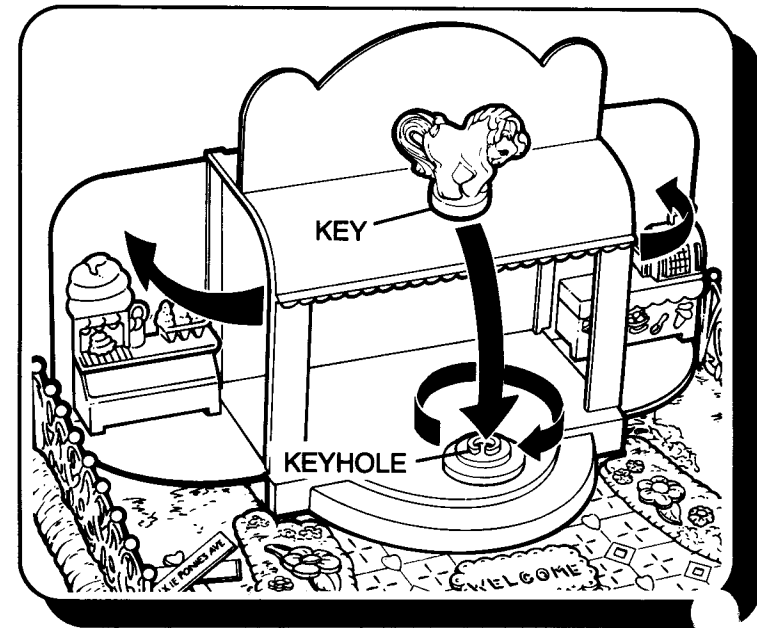

10. To open shoppe, place Petite Pony "key" (located under pony's feet) into circular "keyhole" in base, aligning "U"-shaped groove in key with "U"-shaped ridge in keyhole. Turn pony a quarter of a turn. Side walls will swing open.

