

My Little Pony

PONY PERM SHOPPE INSTRUCTIONS

Ages: 3 and up

Remove all pieces from plastic frames.

If you have difficulty, have an adult use safety scissors.

Remove all pieces from plastic bags and discard bags IMMEDIATELY.

RIGHT SIDE OF ROOF, WALLS AND FLOOR:

1. Locate roof section, floor section, front wall section and rear wall section all marked with an "R". Place roof section on flat surface so that holes are facing up. Insert posts on rear wall section into holes in roof. Press together connecting sides of front wall section and rear wall section. Insert posts on front wall into holes in roof. (ILL. 1)

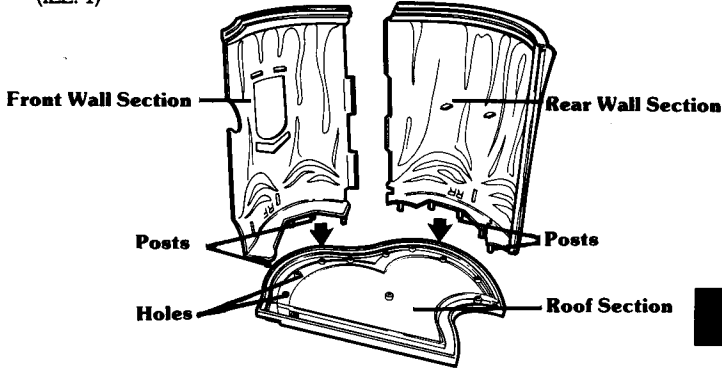

LEFT SIDE OF ROOF, WALLS AND FLOOR:

1. Locate roof section, floor section, front wall section and rear wall section all marked with an "L". Place roof section on flat surface so that holes are facing up. Insert posts on rear wall section into holes in roof. Press together connecting sides of front wall section and rear wall section. Insert posts on front wall into holes in roof. (ILL. 4)

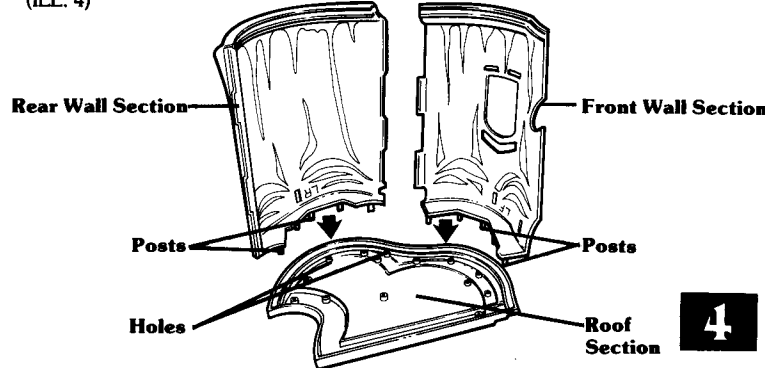

2. Slide floor section into wall sections so that each notch marked "Slot" on floor fits around each rib in wall grooves. Slip tabs on floor into wall grooves. Press snaps on floor over wall edge, making sure snaps are securely attached to edge. (ILL. 2)

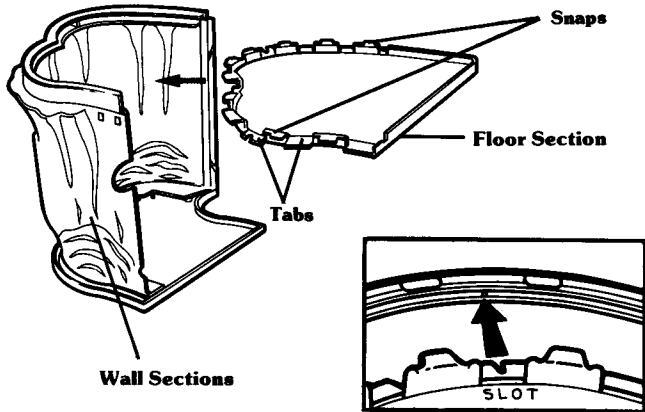

2. Slide floor section into wall sections so that each notch marked "Slot" on floor fits around each rib in wall grooves. Slip tabs on floor into wall grooves. Press snaps on floor over wall edge, making sure snaps are securely attached to edge. (ILL. 5)

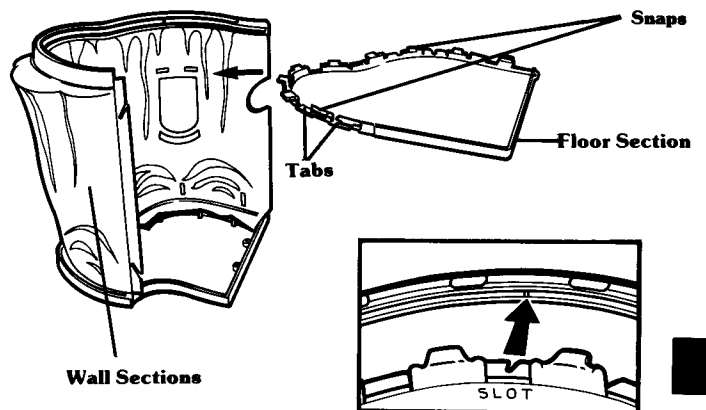

PONY PERM SHOPPE:

Taffy awoke to find a curler lying beside her bed. Rolled inside the curler was a note that read, "Bring this curler to the Pony Perm Shoppe for a special surprise!" When she arrived at the shop, she found all her friends gathered outside the door, each holding a note just like hers! "I wonder what the surprise is," wondered Taffy to her friends. Just then, the door to the Perm Shoppe swung open, and Fifi appeared with fabulous curls tumbling down her back. The ponies eagerly entered the shop, peeking in the rooms for their surprise. Fifi smiled mischievously at her curious friends, then began to wash Taffy's hair. Next she sprayed Taffy's hair with a mysterious solution in a glistening bottle, and rolled her hair in curlers. In just a few minutes, she unrolled her hair and combed it out. "What gorgeous curls!" cried Locket. "They're just as beautiful as Fifi's!" cried Love Melody. "Surprise!" cried Fifi with delight. "Introducing Fifi's Fashion Foam!" The other ponies could hardly wait for their turn to use Fifi's Fashion Foam and see what spectacular results it would bring!



3. Insert light holder into hole in light. Press light holder into hole in roof. Repeat for other 2 lights. (ILL. 6)

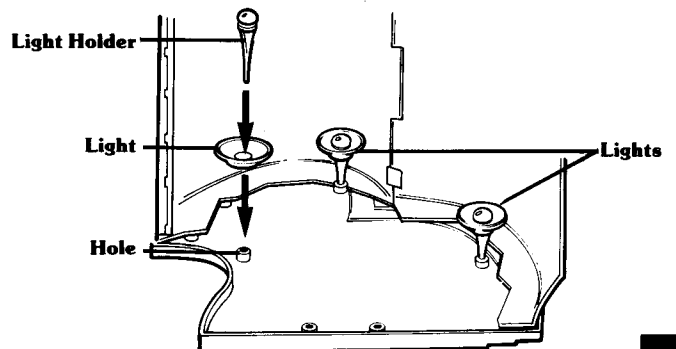

3. Insert fan holder into hole in center of fan. Press fan holder into hole in roof. (ILL. 3)

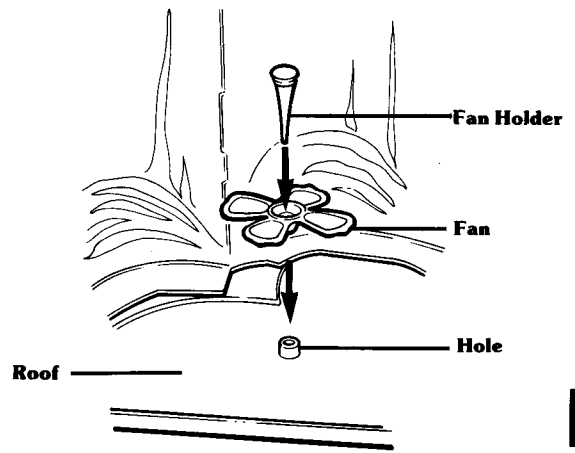

3

1

2

6

4. Insert posts in boutique sign into holes in roof. (ILL. 7)

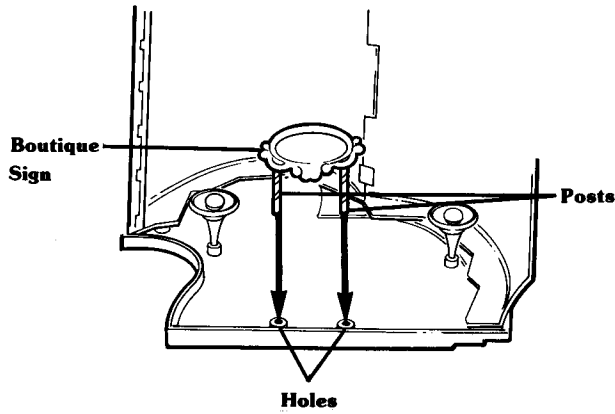

7

5. Snap front step onto floor. (ILL. 8)

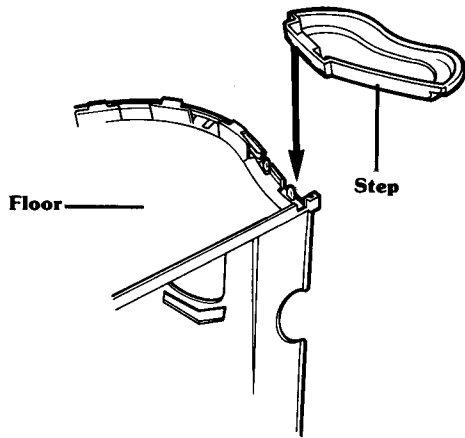

8

DOORS:

Turn playset so that front is facing toward you. Slide bar on right half of door into slot in right side. Snap posts on door into holes in wall. Repeat for left side with left half of door. (ILL. 11)

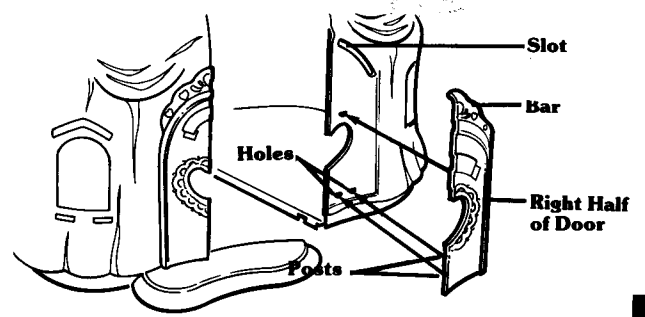

11

WINDOWS:

Slide bar on right window into slot in right wall. Snap posts on window into holes in wall. Repeat for left wall with left window. (ILL. 12)

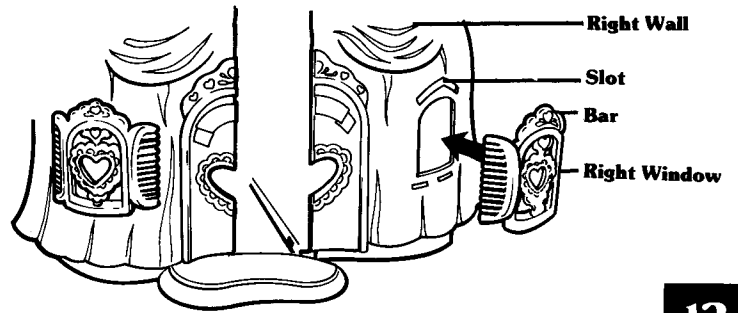

12

RIGHT SIDE, LEFT SIDE AND CENTER PANEL:

1. Turn right and left sides right side up with backs facing toward you. Place center panel with shower nozzle facing away from you. Slide slot in center panel over bar on right side. For left side, slide bar on left side into slot in center panel. (ILL. 9 AND INSET)

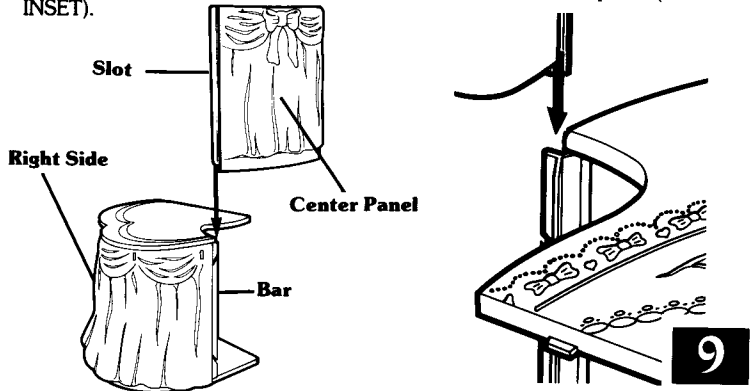

9

CURLER SHELF:

Slip slots on back of shelf onto tabs on rear wall of right side. (ILL. 13)

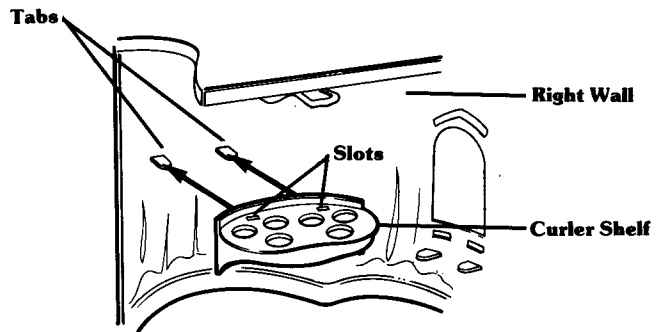

13

2. Press center panel cover onto top of center panel. (ILL. 10)

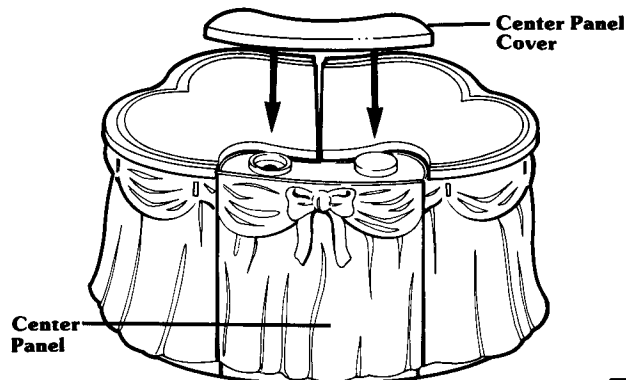

10

ACCESSORY SHELF:

Slip slots on back of shelf onto tabs on front wall of right side. (ILL. 14)

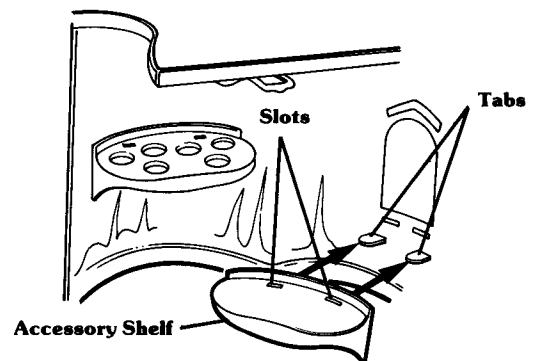

14

TOWEL HOLDER:

Snap posts on towel holder into holes in center panel. (ILL. 15)

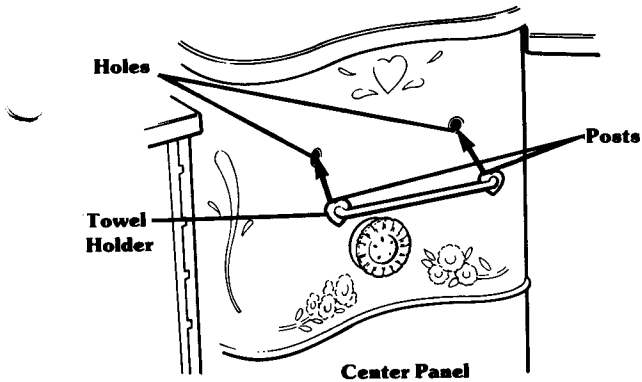

15

2. Snap counter top onto assembled counter. (ILL. 18)

3. Place sink basin inside sink counter. (ILL. 19) Place assembled sink against center panel under shower nozzle.

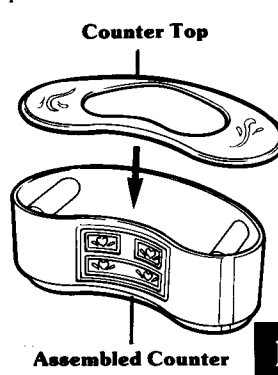

18

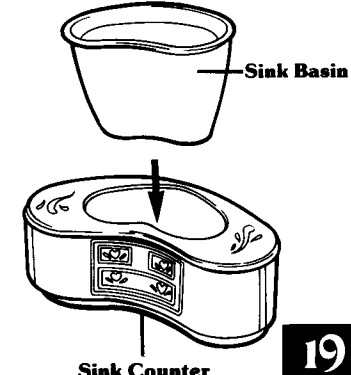

19

LACE EDGING AND SNAP-ON BOWS:

NOTE: There are 2 CURVED BOWS and 8 FLAT BOWS. Make sure you snap a CURVED BOW into the hole where the front wall and rear wall connect. (SEE ILL. 16A)

1. Place lace edging along top of right side from beginning of front wall to end of rear wall. Do not place lace on back of center panel. Starting at beginning of front wall, snap posts on bows into holes in wall sections, pushing posts through lace. Make sure CURVED BOW is placed in hole where front and rear walls connect. (ILL. 16B)
2. Repeat for left side of Pony Perm Shoppe, using remaining lace and bows. Do not place lace on back of center panel. Again, make sure CURVED BOW is placed in hole where front and rear walls connect.

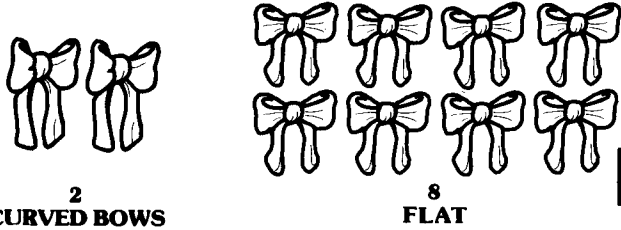

16A

DRIP TRAY:

Place drip tray in front of sink counter as shown. (ILL. 20) Drip tray helps catch any water that may fall while you wash pony's hair.

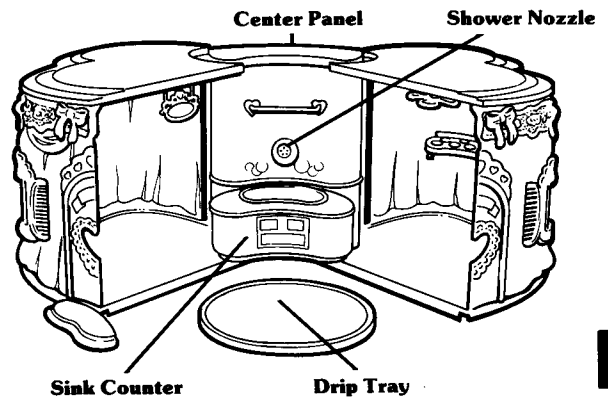

20

Front Wall
Right Side

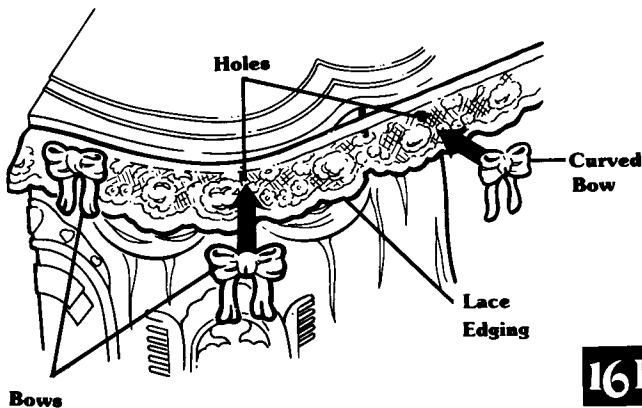

16B

BEAUTY CHAIR:

Insert post on base into hole in seat. (ILL. 21)

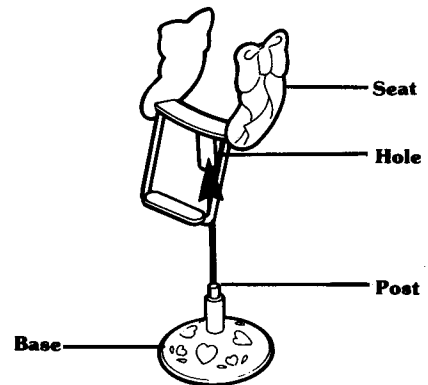

21

SINK COUNTER AND BASIN:

1. Insert posts on front half of counter into holes in rear half of counter. (ILL. 17)

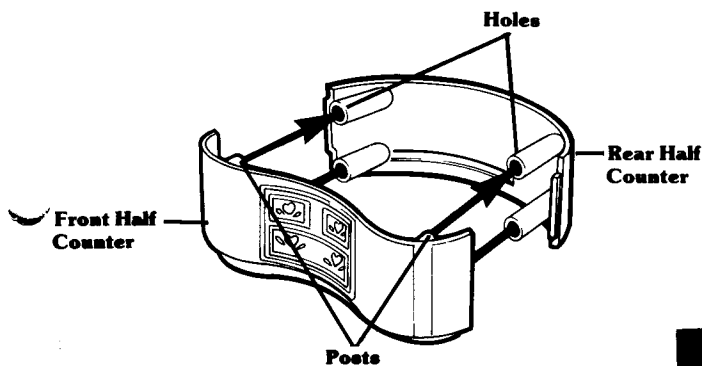

17

RIBBON RACK:

Insert post on rack into hole in base. (ILL. 22)

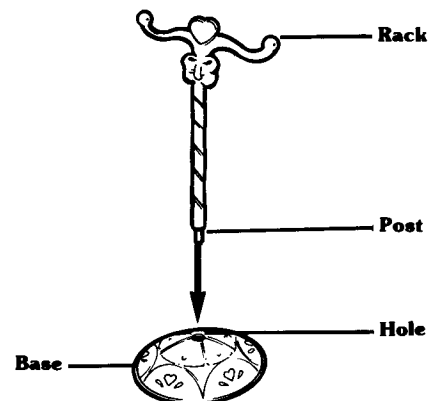

22

BEAUTY CART:

1. Place cart on flat surface with grooves facing up. Snap posts on right and left legs into grooves. Snap wheels onto ends of legs. (ILL. 23)

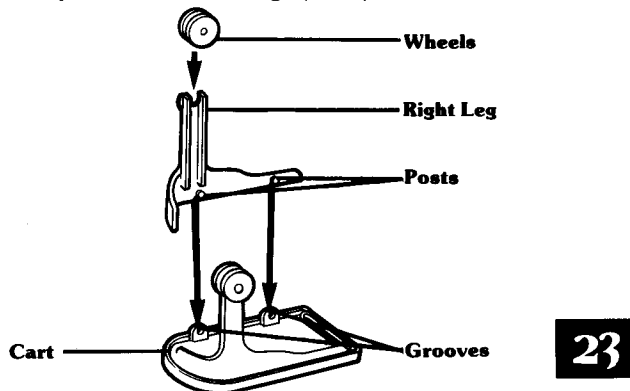

2. Turn cart with top facing up. Insert handle as shown. Place tray in indentation on top of cart. (ILL. 24)

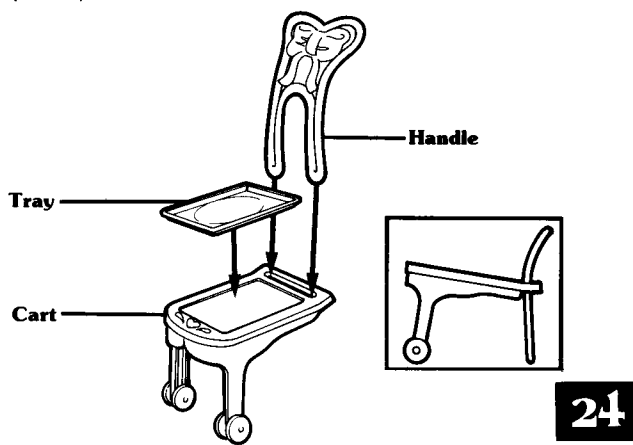

LABELS:

Peel and apply labels as shown. (ILLS. 27 and 28)

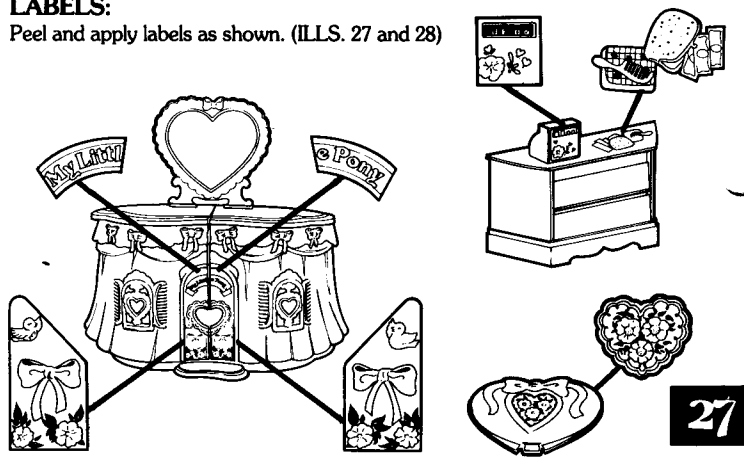

MIRROR:

1. With front of mirror facing you, press tabs on bottom of mirror into holes in right and left feet. (ILL. 25)

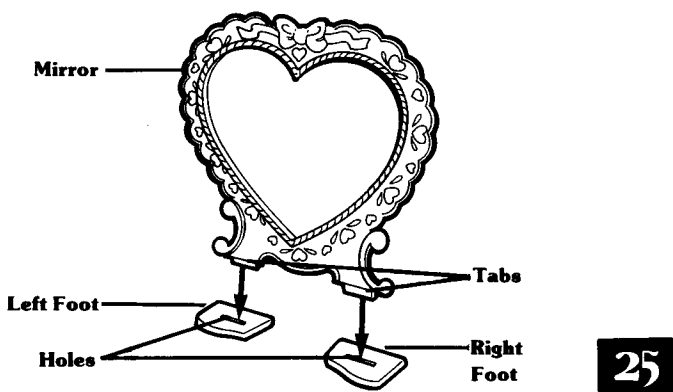

2. To apply label to mirror, peel small adhesive cover from back of label. Apply exposed section of label to mirror. (ILL. 26)
 3. Peel remaining adhesive cover from back of label. Apply rest of label to mirror. Apply smoothly and carefully as label cannot be repositioned.
 4. Place mirror on top of center panel cover.

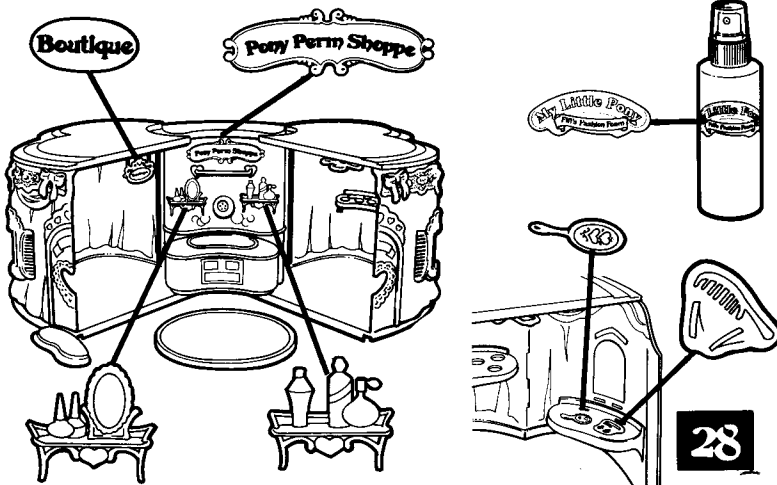
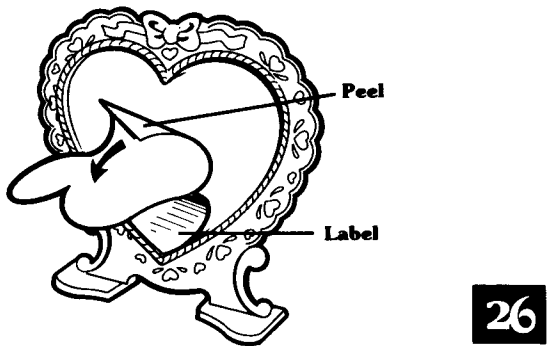

HOW TO USE FIFI'S™ FASHION FOAM:

Perm your pony's hair in minutes with Fifi's Fashion Foam!

1. LIGHTLY spray pony's hair with Fifi's Fashion Foam. You need only a small amount of solution to perm pony's hair (about 3 pumps).
 2. Place pony on a towel and comb solution through pony's hair. Comb hair for several minutes to make sure solution is applied evenly to hair.
 3. When pony's hair is almost dry, roll hair in curlers. Remember: the more curlers you use and the less hair on each curler gives you tighter curls.
 4. Leave hair in curlers for 5-10 minutes. After 5-10 minutes, unroll curlers and comb hair to style.
- NOTE: Pony's hair can be curled again without re-spraying. Simply roll hair in curlers again for several minutes.

HOW TO USE SHOWER:

Use the working shower to remove perm from pony's hair! Wash hair with your favorite shampoo or soap, rinse hair and allow to dry.

1. Remove sink basin from counter. Fill basin with water to line marked inside basin. Remove center panel cover from center panel. Slowly pour water into reservoir. Replace center panel cover.
2. Gently pull hose out of the wall as far as it can go. Press button on nozzle to start water flow. Shower nozzle will release water as long as you press button. To stop water flow, release button.
3. After washing pony's hair, discard water in sink basin and drip tray. To help keep reservoir in good condition, completely drain reservoir after each shower. Allow pieces to dry before storing.

HOW TO USE MAKE-UP:

Use the 3 make-up applicators included with the Pony Perm Shoppe to apply make-up to your ponies! Create glamorous or fun looks for casual afternoon parties or elegant formal dances! Make-up is nontoxic and washes off easily using a soft face cloth, soap and water.

