

My Little Pony

Poof 'n Puff Perfume Palace™

INSTRUCTIONS

Ages: 3 & Up

- 1.** Snap center tab on awning into slot in Perfume Palace door. Snap remaining two tabs on awning into door. (ILL. 1)

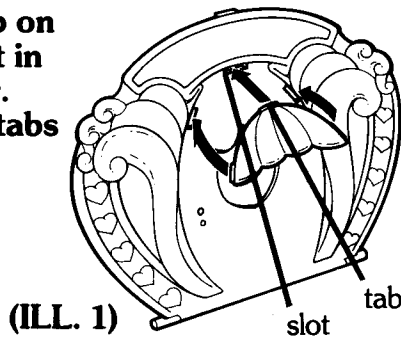

- 2.** Insert post on doorknob into hole in Perfume Palace door. (ILL. 2)

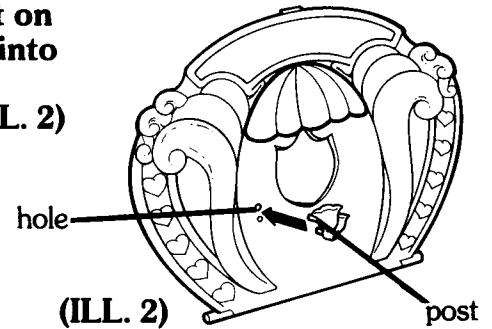

- 3.** With decorated side of Perfume Palace door facing away from doorway, place posts on straight end of door into hooks in Perfume Palace's floor. Close door. (ILL. 3a)

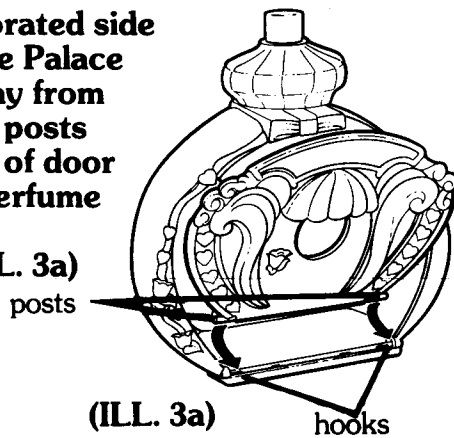

- Insert tabs on back of Perfume Palace's floor into slots in back of base. Place tabs on front of Perfume Palace floor into slots in front of base. Open door. Press both sides of the Perfume Palace floor (near the place where the door is attached to the palace), listening for a snap each time. (ILL. 3b)

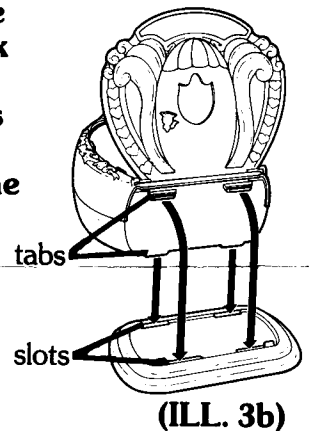

- 4.** To assemble vanity, insert posts on front of vanity into holes in back of vanity. (ILL. 4a)

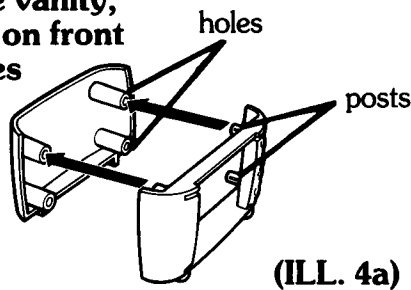

- Locate door marked "R" (found on inside of door). Place door on right half of vanity front, and press tabs on door into grooves in vanity. Repeat with left door for left half of vanity front. Snap top onto vanity. (ILL. 4b)

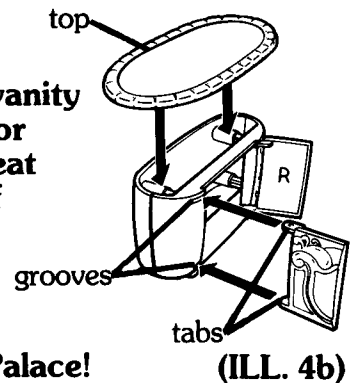

You can play with the vanity inside or outside the Perfume Palace!
Store fashion accessories inside the vanity when the beauty session is over!

- 5.** To assemble a purse for your ponies, snap the keyholes on the strap onto the posts on the purse. The purse snaps closed and reopens! (ILL. 5)

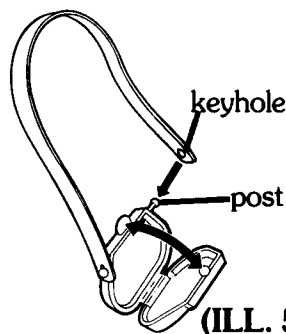

- 6.** Peel and apply mirror label to inside wall of Perfume Palace. (ILL. 6)

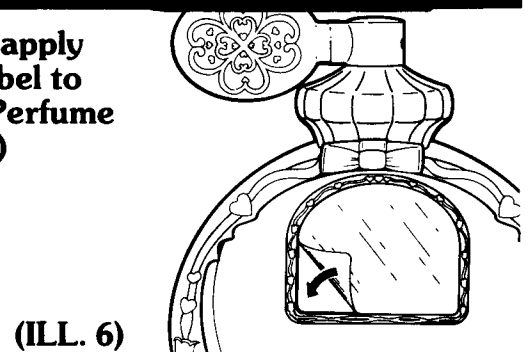

7. Peel and apply labels as shown. Decorate the faces or bodies of any of your ponies with the pretty floral stickers! (ILL. 7)

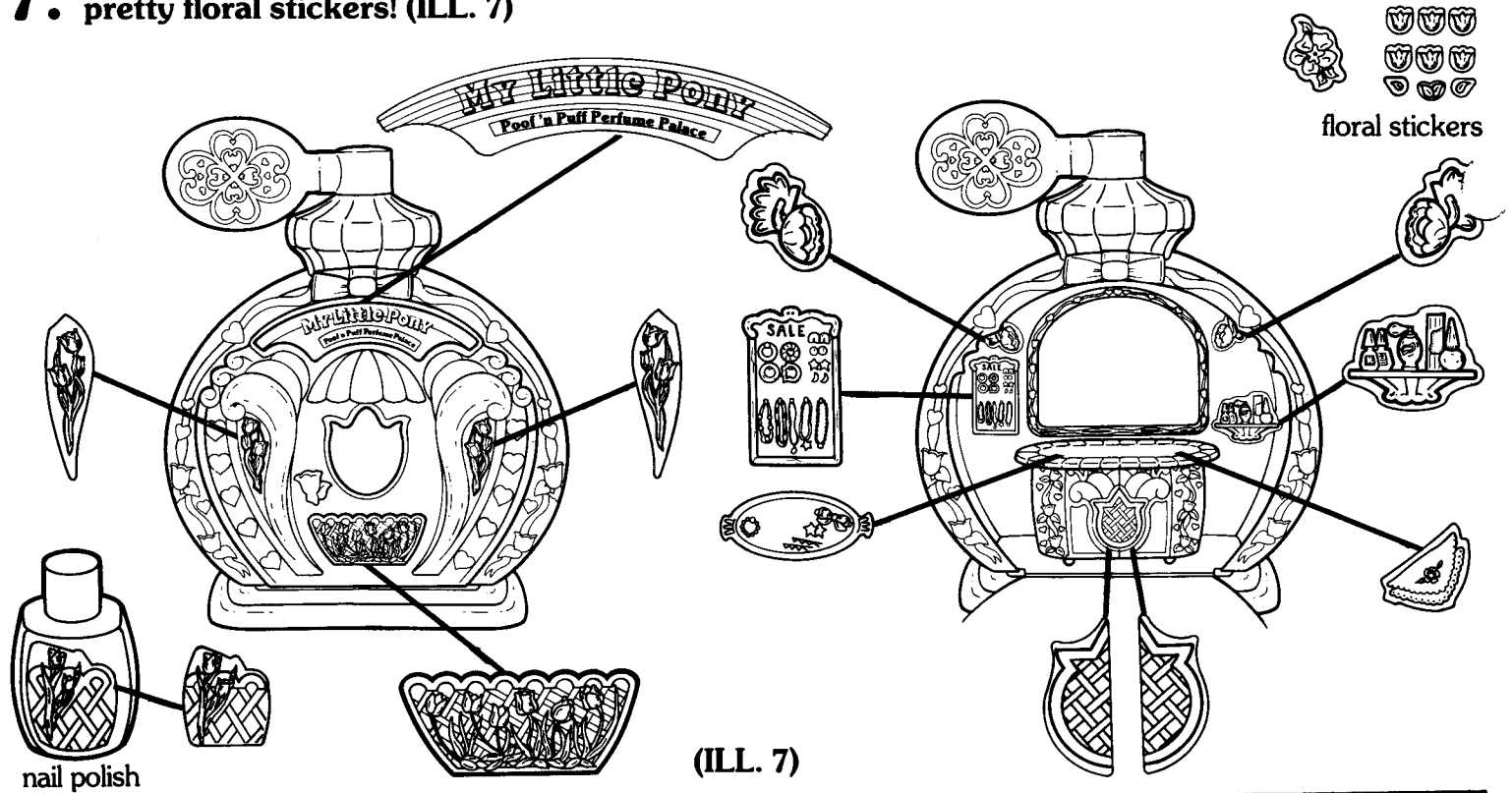

(ILL. 7)

8. Squeeze the atomizer bulb to spray perfume-scented air. It's scent-sational! (ILL. 8)

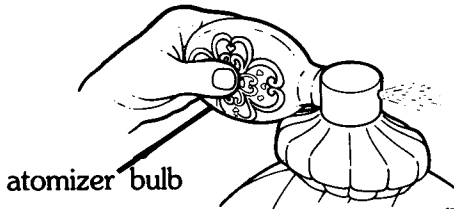

(ILL. 8)

9. To make your ponies look glamorous, help them paint their nails and put on lipstick! To keep the nail polish from smudging, wait until the polish is completely dry before playing with your ponies. The nail polish is easy to remove—just peel it off when you're done. The lipstick wipes off easily with a dampened, soft cloth or tissue. Both the nail polish and lipstick are nontoxic. NOTE: Do not use the lipstick or nail polish on So Soft™ (flocked) Ponies.

The Story of the Poof 'n Puff Perfume Palace

Princess Dawn eagerly rummaged in her closet to find a beautiful gown to wear to the Royal Ball. She tried on a dazzling dress that glimmered with jewels. "Now for the finishing touch!" she thought, glancing at one of her perfume bottles. Suddenly, she had a spectacular idea! She raced to a nearby field and placed the perfume bottle on the ground. Calling upon all her Princess Pony magic, Princess Dawn blinked her eyes twice. POOF! PUFF! The perfume bottle grew and g-r-e-w until it was just the right size for the ponies to go inside! The ponies gathered around to admire the magical new place as Princess Dawn opened the door and stepped inside. "Welcome to the Poof 'n Puff Perfume Palace!" Princess Dawn exclaimed, wrapping a feathered boa around her neck and tossing a glittering scarf to Buttons. With a mischievous giggle, Princess Dawn squeezed the bulb on top of the palace, spraying all her friends with a beautiful perfume scent! "What a scent-sational place to get ready for the Royal Ball!" laughed the ponies, stepping happily inside the pretty palace.



4651 P/N 198805.00B
©1987 Hasbro, Inc.,
Pawtucket, RI 02862 U.S.A.
All Rights Reserved.

COSMETIC INGREDIENTS:
NAIL POLISH: WATER, ACRYLATES COPOLYMER, DIMETHICONE, GLYCERINE, DIBUTYL PHTHALATE, PROPYLENE GLYCOL, QUATERNIUM 15, POLYACRYLATE COPOLYMER, DIOCTYL SODIUM SULFOSUCCINATE, DIAZOLIDINYL UREA, MAY CONTAIN: MICA, IRON OXIDE, FERRIC AMMONIUM FERROCYANIDE, D&C YELLOW #5 ALUMINUM LAKE, D&C RED #6 BARIUM LAKE, D&C RED #7 CALCIUM LAKE, D&C RED #34 CALCIUM LAKE, TITANIUM DIOXIDE.

LIPSTICK: CASTOR OIL, CARNAUBA, ISOPROPYL PALMITATE, CANDELILLA WAX, CAPRYLIC/CAPRIC TRIGLYCERIDE, PETROLATUM, LANOLIN, BEESWAX, OZOKERITE, STEARIC ACID, SORBITAN STEARATE, CETYL ALCOHOL, PROPYL PARABEN, BHA, FRAGRANCE. MAY CONTAIN: TITANIUM DIOXIDE, D&C RED #6 BARIUM LAKE, D&C RED #7 CALCIUM LAKE.