

# NERF®

AGES 8+

61575

## N-Strike™

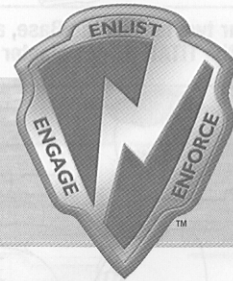

**⚠ CAUTION:** Do not aim at eyes or face.

**TO AVOID INJURY:** Use only darts designed for this product. Do not modify darts or dart blasters.

**IMPORTANT NOTE:** Not for use with projection, flat panel, LCD or plasma displays/televisions.

Thank you for purchasing the NERF N-STRIKE blaster. Be sure to read and follow all instructions carefully before using this product.

Use all 3 blasters separately or snap them together to create the UNITY POWER SYSTEM™.

### TO USE THE DVD:

Place the DVD in the DVD player. After the opening introduction, the DVD will wait for you at the menu screen. If your DVD player does not automatically start the DVD, press the PLAY button to start the intro.

Use only the SCOUT IX-3™ and HORNET AS-6™ with the DVD, and stand at least 10 feet away from the TV when launching.

NOTE: DVD NOT FOR USE WITH TITAN AS-V.1™ BLASTER.

### TITAN AS-V.1™ BLASTER WITH THE MEGA MISSILE™

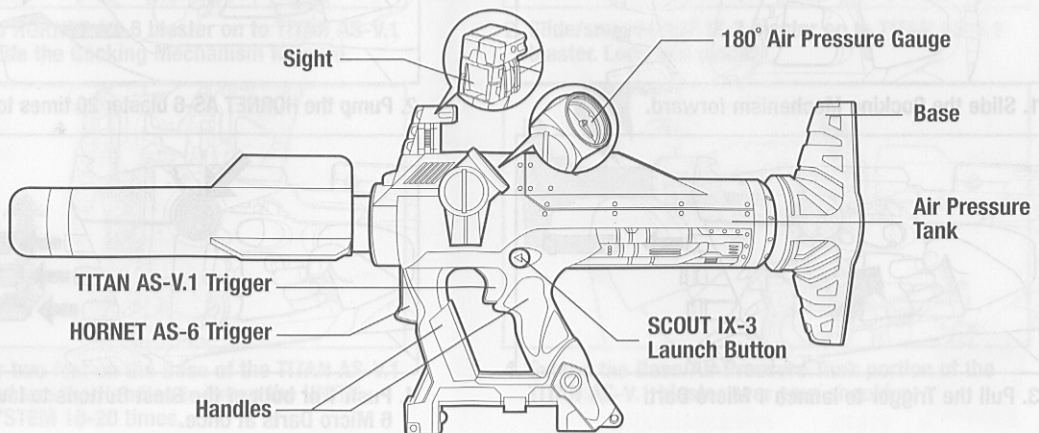

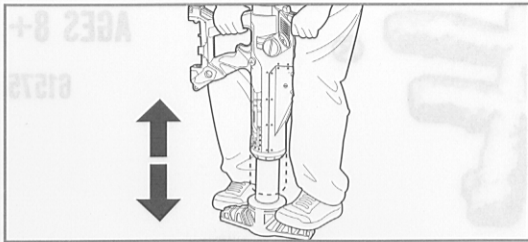

1. Place your two feet on the Base, and use the Handles to Pump the TITAN AS-V.1 blaster 16 times.

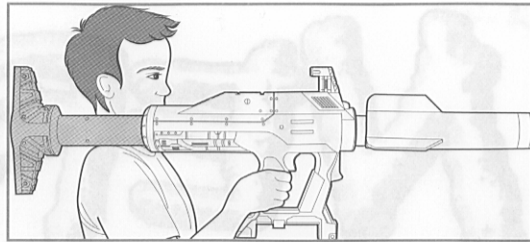

2. Extend the Base/Air Pressure Tank portion over your shoulder.

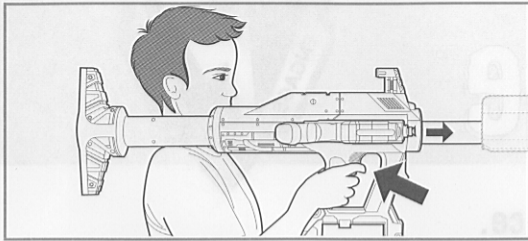

3. Pull the TITAN AS-V.1 Trigger fast to let the MEGA MISSILE soar!

## HORNET AS-6™ BLASTER WITH 6 MICRO DARTS

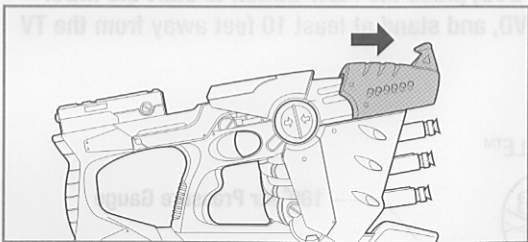
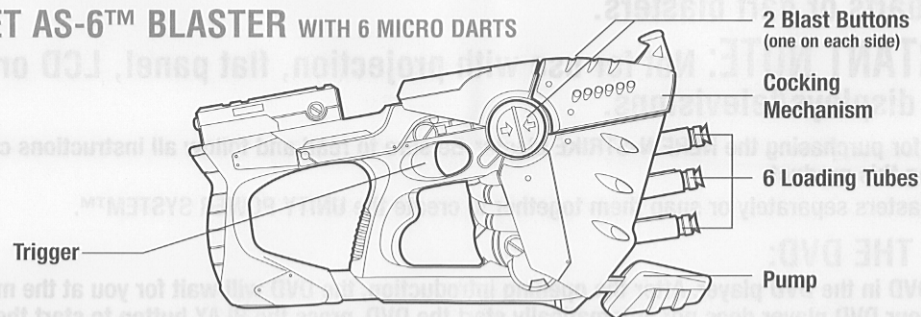

1. Slide the Cocking Mechanism forward.

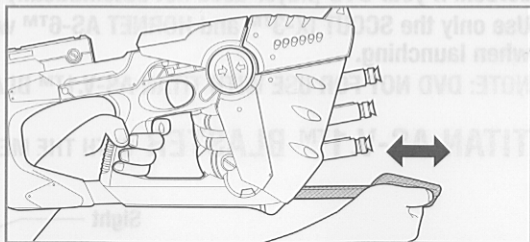

2. Pump the HORNET AS-6 blaster 20 times to pressurize.

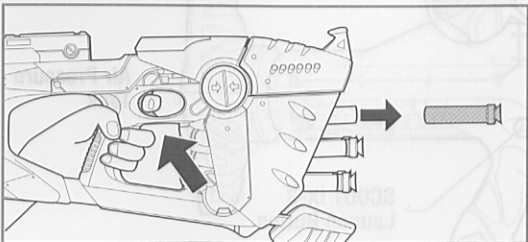

3. Pull the Trigger to launch 1 Micro Dart.

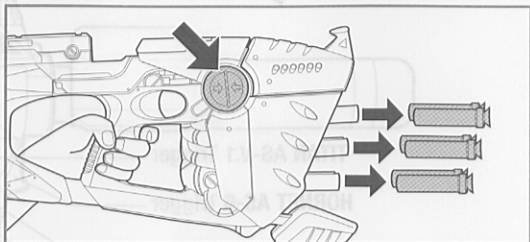

4. Push 1 or both of the Blast Buttons to launch all 6 Micro Darts at once.

## SCOUT IX-3™ BLASTER WITH 3 MICRO DARTS

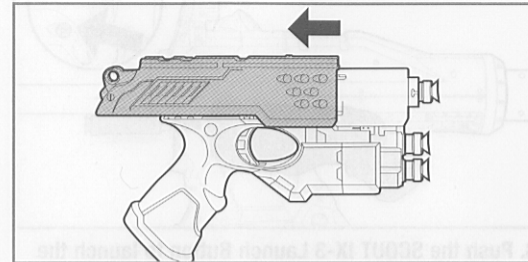
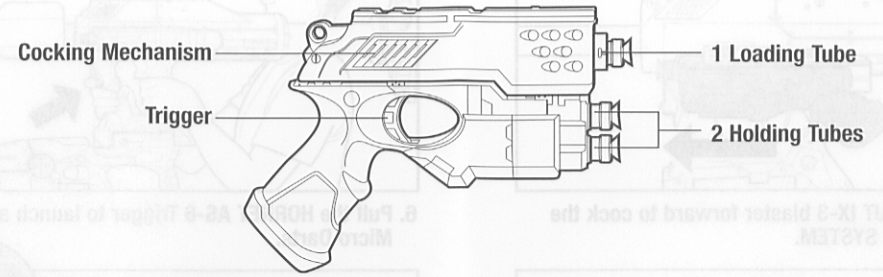

1. Slide the Cocking Mechanism backwards.

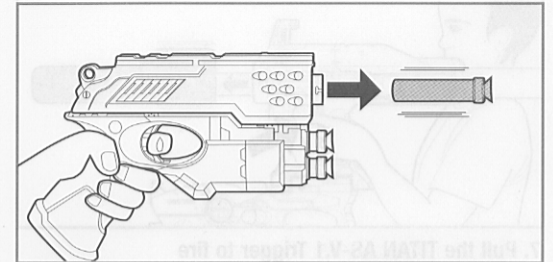

2. Pull the Trigger to launch 1 Micro Dart.  
3. Refill the Loading Tube from the 2 Holding Tubes as necessary.

## UNITY POWER SYSTEM™ TO ASSEMBLE:

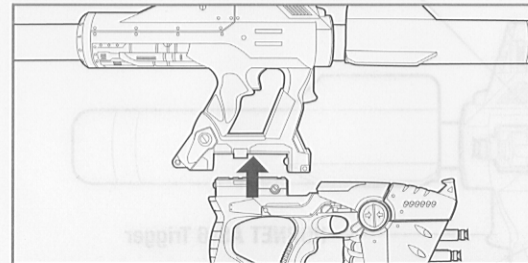

1. Push/snap HORNET AS-6 blaster on to TITAN AS-V.1 blaster. Slide the Cocking Mechanism forward.

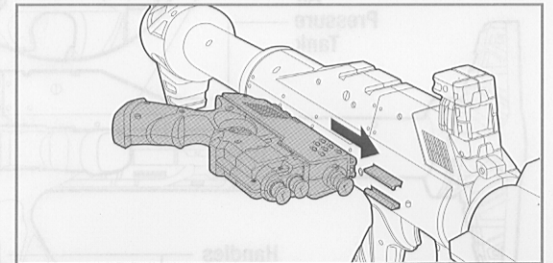

2. Slide/snap SCOUT IX-3 blaster on to TITAN AS-V.1 blaster. Lock into place.

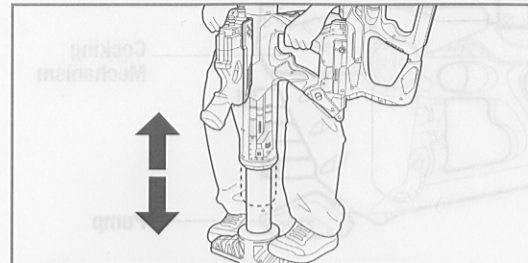

3. Place your two feet on the Base of the TITAN AS-V.1 blaster, and use the Handles to Pump the UNITY POWER SYSTEM 18-20 times.

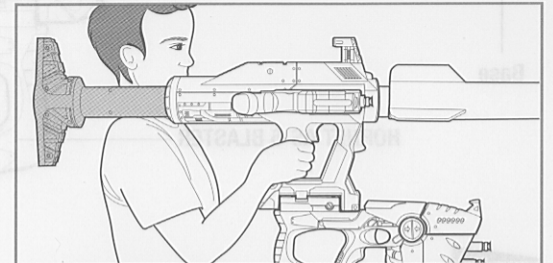

4. Extend the Base/Air Pressure Tank portion of the TITAN AS-V.1 blaster over your shoulder.

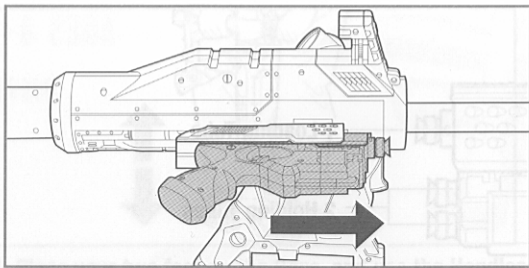

5. Push the SCOUT IX-3 blaster forward to cock the UNITY POWER SYSTEM.

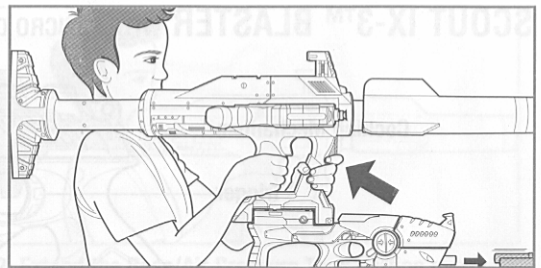

6. Pull the HORNET AS-6 Trigger to launch all 6 of the Micro Darts.

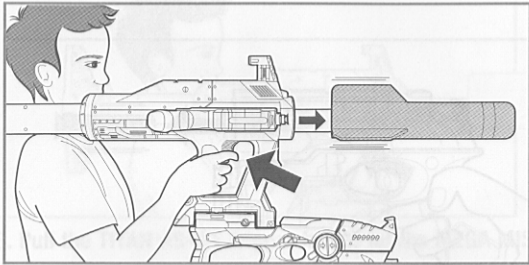

7. Pull the TITAN AS-V.1 Trigger to fire the MEGA MISSILE.

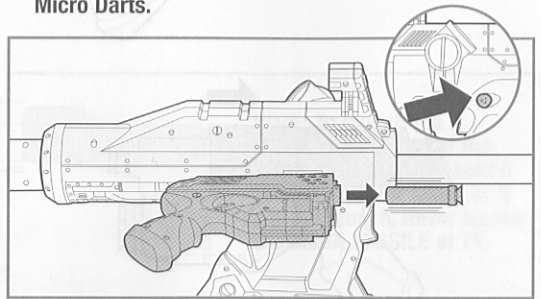

8. Push the SCOUT IX-3 Launch Button to launch the SCOUT IX-3 Micro Dart.

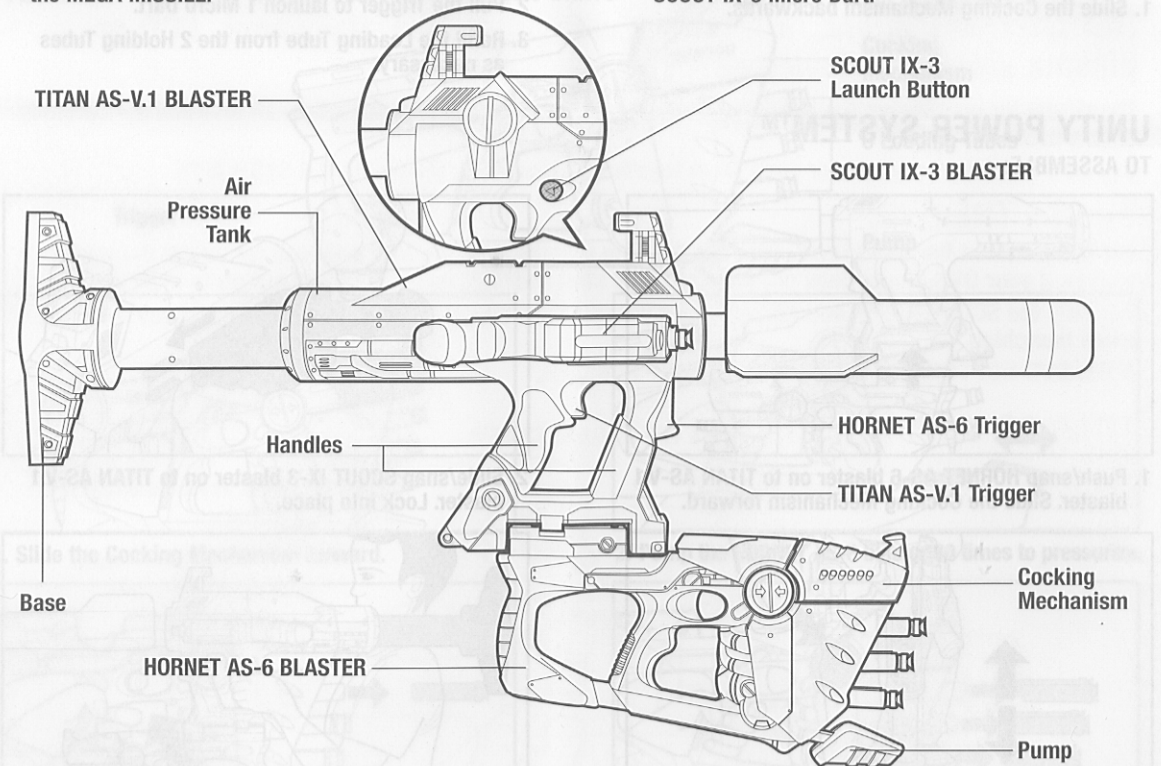

© 2004 Hasbro. All Rights Reserved.  
 ® denotes Reg. U.S. Pat. & TM Office.  
 61575 P/N 6364520000

**NERF.COM**  
 FOR NEW PRODUCTS AND OFFERS  
 Questions? Call: 1-800-327-8264

# NERF®

AGES 8+  
61575

## N-Strike™

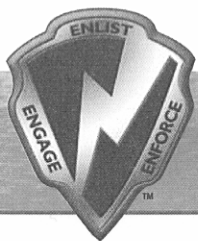

TO ATTACH THE MUZZLE TO THE TITAN AS-V.1™ BLASTER:

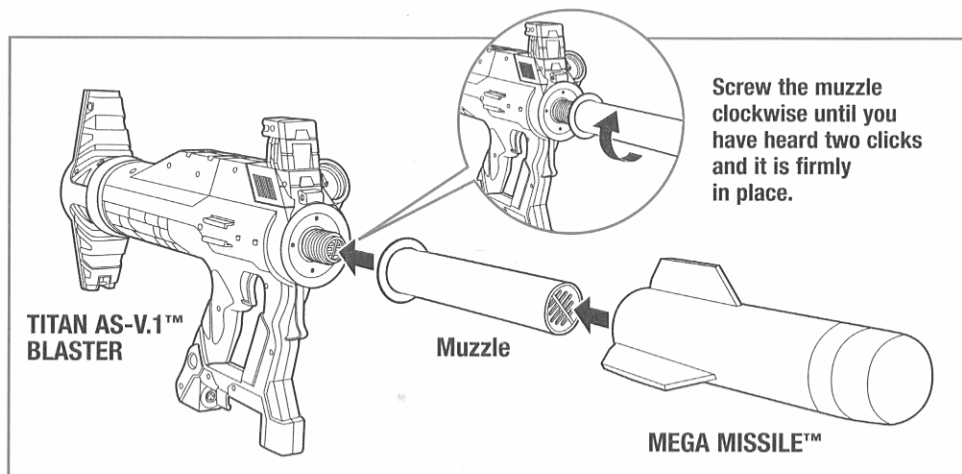

TO PROPERLY OPERATE THE HORNET AS-6™ BLASTER:

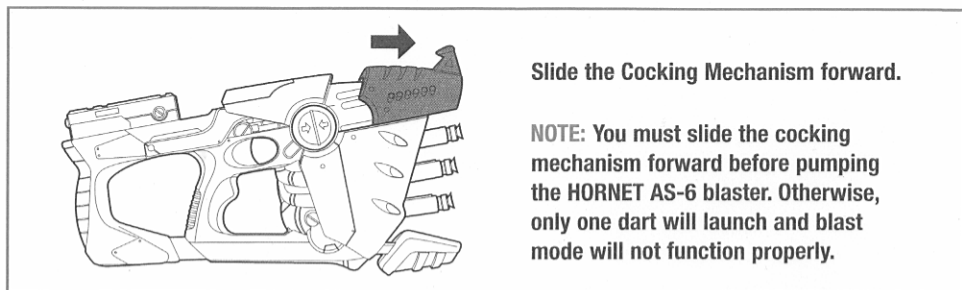

© 2004 Hasbro. All Rights Reserved.  
® denotes Reg. U.S. Pat. & TM Office.  
P/N 6403330000

NERF.COM  
FOR NEW PRODUCTS AND OFFERS

Questions? Call: 1-800-327-8264