

# Make An Instrument

## Clarinet Keys

If the clarinet keys come off, they can easily be re-attached to the clarinet tube. Align spring on key between the 2 triangles. Snap holes on key onto knobs on posts.

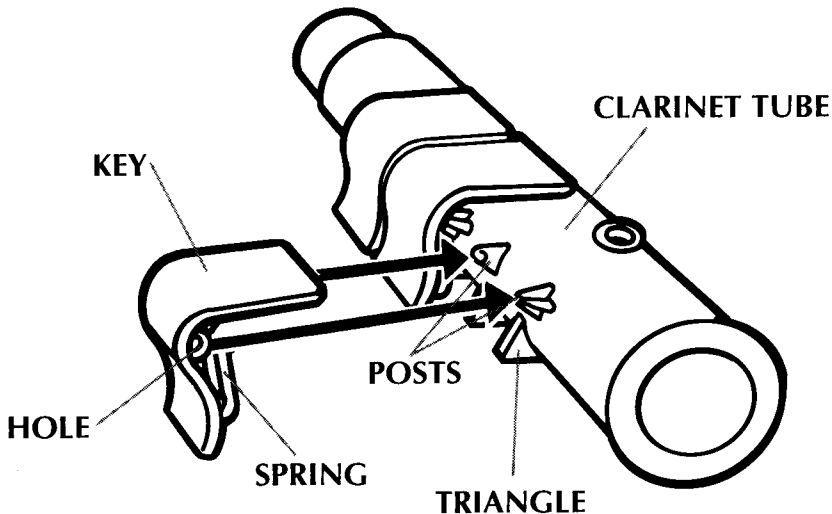

Product and colors may vary.

© 1996 Viacom International Inc. All Rights Reserved. Nickelodeon and Nick Jr., and all related titles, logos and characters, if any, are trademarks of Viacom International Inc.

PLAYSKOOL® is a trademark of Hasbro, Inc. ©1996 Hasbro, Inc., Pawtucket, RI 02862 USA.

All Rights Reserved.

® denotes Reg. U.S. Pat. & TM Office

MADE IN CHINA. P/N 46970100





# Make An Instrument

Thank you for purchasing this toy. If you have any questions or comments about this toy, please call us toll free at 1-800-PLAYSKL.

## Soundmaking Pieces

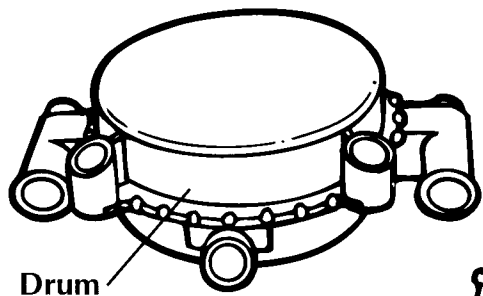

Drum

Squeeze/Squeaker Bulb

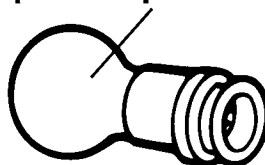

Xylophone

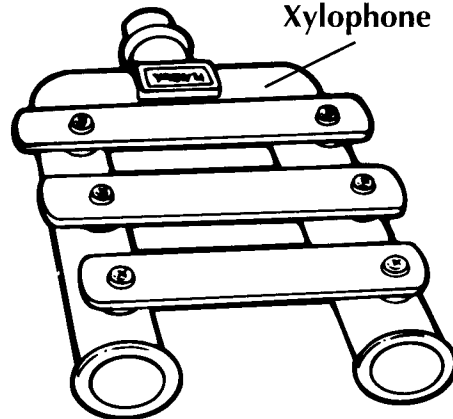

2 Whistles

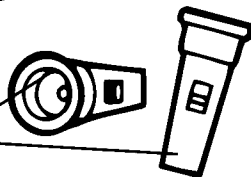

"Clarinet" Tube

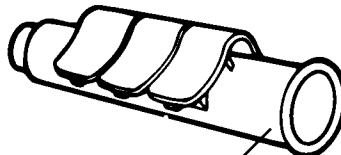

## Non-Soundmaking Pieces

90° Elbow



Mouth Piece



45° Elbow



3 Bell Ends

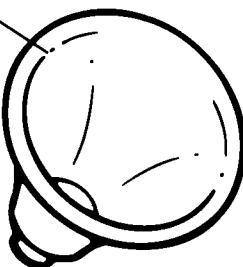
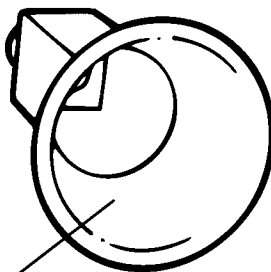
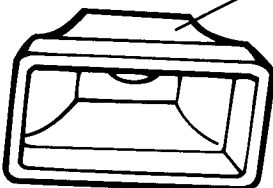

"Slide Whistle" Tube

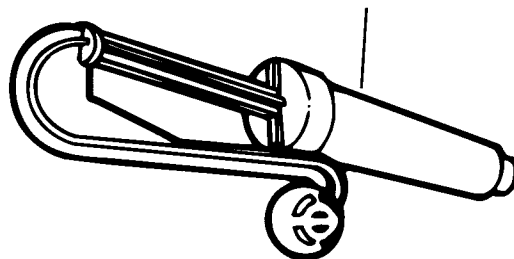

"Flute" Tube

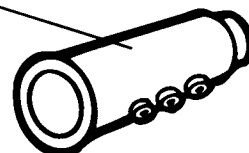

2 Drumsticks/Xylophone Hammers

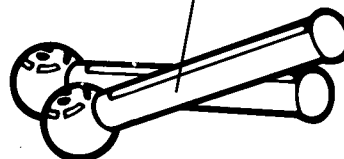

**Make An Instrument** is a great toy for more than one child to play with at a time. Children connect the pieces different ways to create wacky musical instruments! They can assemble several instruments at one time, or make one big instrument using lots of pieces.

Here are two simple guidelines for children to keep in mind as they play:

**1. Attaching the Pieces:**

You must always attach an end with a "lip" to an end without a "lip". Look at these illustrations to see the difference between the two types of ends:

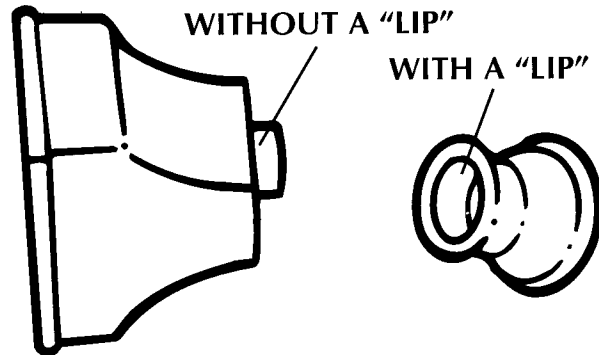

**2. Soundmakers & Non-Soundmakers:**

Soundmaking pieces can make fun sounds by themselves. Non-soundmaking pieces must be attached to soundmaking pieces to make honks, whistles and more wacky music!

Note: Store the drumsticks in the loops on the rim of the drum.

**Some Instruments To Make**  
(Try these, then create your own!)

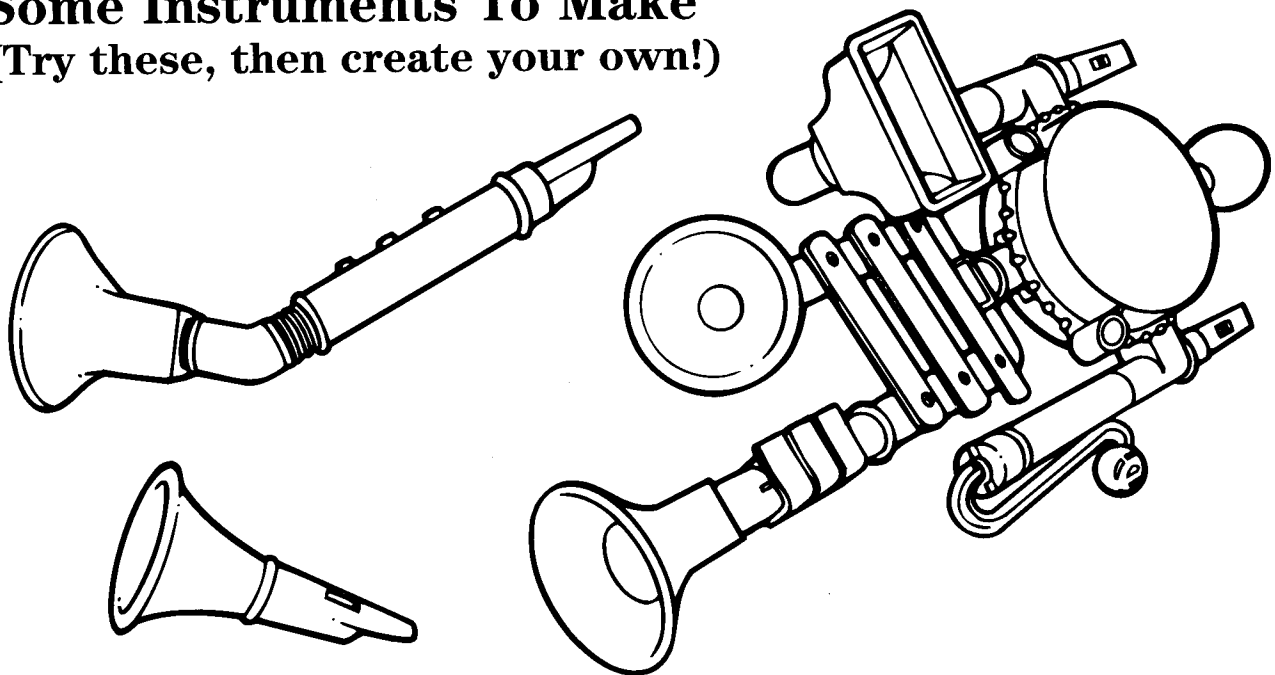

Product and colors may vary.

© 1995 Viacom International Inc. All Rights Reserved. Nickelodeon and Nick Jr., and all related titles, logos and characters, if any, are trademarks of Viacom International Inc. ©1995 Hasbro, Inc., Pawtucket, RI 02862 USA. PLAYSKOOL® is a trademark of Hasbro, Inc. All Rights Reserved. ® denotes Reg. U.S. Pat. & TM Office **MADE IN CHINA.** P/N 46358900