

MAKES REAL FOOD!

NOW YOU'RE COOKING!™

AN IMPORTANT NOTE TO THE NEW COOK'S PARENT: YOU'RE THE COACH!

CAUTION: Some recipes may require use of table knives, can openers, blenders and microwaves. Adult supervision with these recipes is very important to prevent accidental cuts or burns

Now, You're Cooking! is designed with the young cook in mind — to teach children basic cooking skills, while having fun creating new and tasty recipes!

It is important that you, the cooking coach, review all the **Now You're Cooking!** utensils and recipes with your child before beginning. Encourage your child to learn each utensil's cooking function, its proper use, and most importantly, WHICH UTENSILS ARE AND ARE NOT MICROWAVABLE. It's easy to distinguish which utensils are microwavable by the microwave mark. For added convenience, all the **Now You're Cooking** utensils are dishwasher safe for easy clean-ups.

Please take time to discuss basic kitchen safety and the correct usage of all kitchen tools and equipment before your child begins any type of kitchen endeavor. The good cooking habits they learn now will last through adulthood.

COOL COOKIES 'N CAKES™

Instructions



HOW TO USE THE COOKIE CUTTER

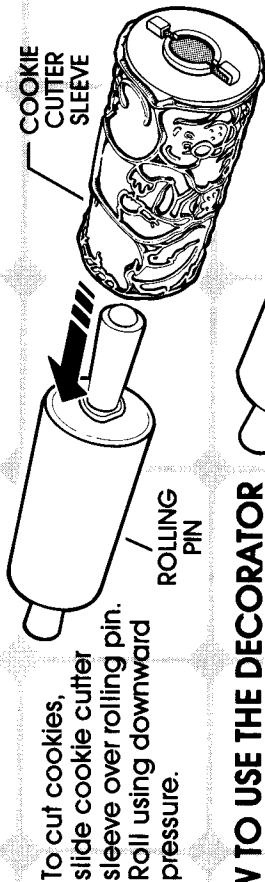

To cut cookies, slide cookie cutter sleeve over rolling pin. Roll using downward pressure.

HOW TO USE THE DECORATOR

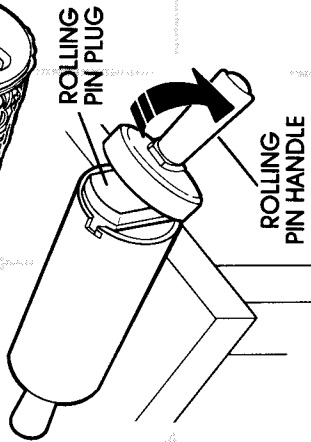

1 Place rolling pin on edge of hard, flat surface. Remove rolling pin handle by pressing down on the end of the handle as shown. Be sure the rolling pin plug is still in position.

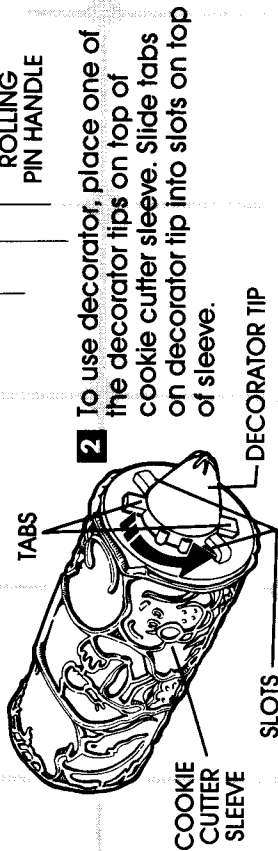

2 To use decorator, place one of the decorator tips on top of cookie cutter sleeve. Slide tabs on decorator tip into slots on top of sleeve.

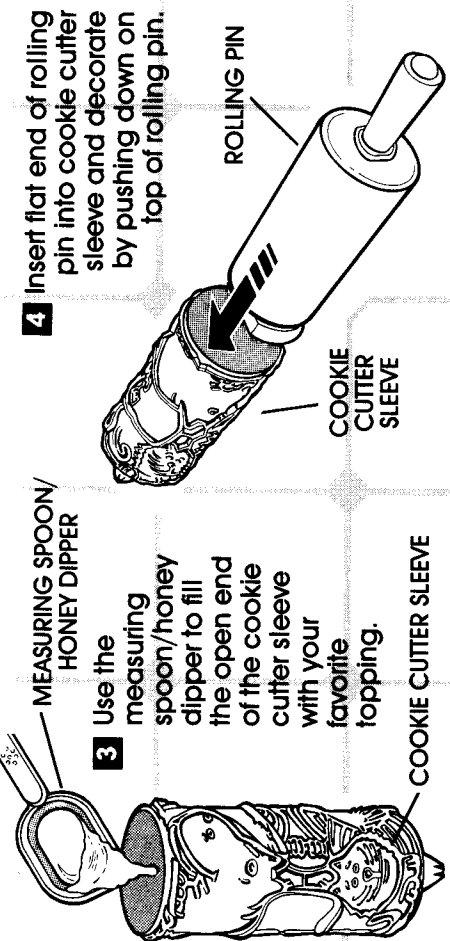

3 Use the measuring spoon/honey dipper to fill the open end of the cookie cutter sleeve with your favorite topping.

4 Insert flat end of rolling pin into cookie cutter sleeve and decorate by pushing down on top of rolling pin.

4490

LET'S BEGIN

Children that are too young to use traditional appliances can learn to cook with the help of the microwave. Before beginning to cook, make sure your child knows the function of the microwave oven as well as basic cooking activities. **It is very important that you supervise your child, especially when a recipe calls for the use of knives, can openers, microwaves and conventional ovens.** Children should get into the habit of rolling up their sleeves, pulling their hair back and washing their hands, as well as keeping the kitchen in tip-top shape! Cooking with your child can be a lot of fun for both of you when it is done properly!

USING A MICROWAVE

- Teach your child that a cool microwave doesn't mean a cool dish inside — hot food probably means a hot dish! Emphasize the use of pot holders when they suspect something is too hot to handle!
- Teach your child to carefully lift any wrapping from microwave-cooked foods to let steam escape and to keep hands and face away from escaping steam.
- Set aside all utensils that can be used in the microwave oven. Familiarize your child with the microwave emblem on the microwavable **Now You're Cooking!** items. Also, make sure your child knows what NOT to use in the microwave oven, i.e. foil wrapper, twist ties, metal plates or pans, and any **Now You're Cooking!** ITEMS WITHOUT THE MICROWAVE MARK.

UNIQUE AND FUN RECIPES

The step-by-step recipe cards found in each **Now You're Cooking!** set are designed to teach children basic cooking skills while having fun! Recipes are divided into three different skill levels, making it easy for younger children to master fundamental cooking skills at their own pace. The most basic skill level is the COOK LEVEL which features recipes that are easy to prepare. The CHEF LEVEL means these recipes require some cutting and heating, and the MASTER CHEF LEVEL features more complicated recipes that require adult supervision. Before beginning each recipe, check the logo at the top of each card, the number of servings you can prepare with it, and the ingredients that are required. You may also want to use the valuable coupon book enclosed so you can shop and save at the same time!

©1987 Hasbro, Inc., Pawtucket, RI 02862 USA All Rights Reserved. Printed in U.S.A.
92701.00B 4490, 4493, 4496

CLEANUP

- When cleaning, remove cookie cutter sleeve from rolling pin and rinse off.

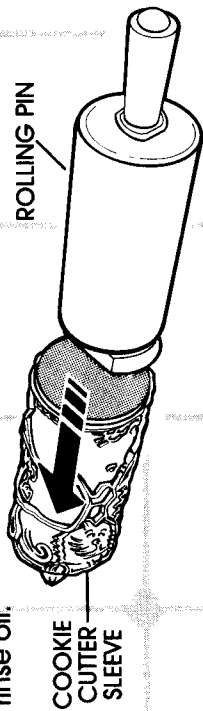

- Turn rolling pin plug. Pull out rolling pin plug. Remove decorator tip from cookie cutter sleeve. Wash decorator tips in dishwasher utensil rack. Wash all other accessories on dishwasher top rack ONLY.

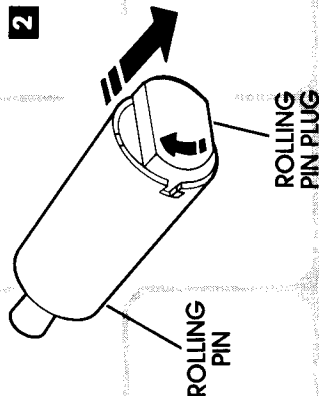

- To reassemble rolling pin, be sure all rolling pin parts are dry. Place rolling pin plug on hard flat surface. Press rolling pin handle onto rolling pin plug.

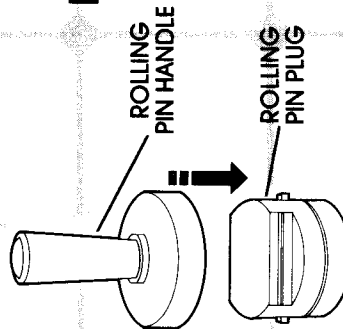

- Fit tabs on rolling pin plug into slots in rolling pin. Turn rolling pin plug until it locks into position.

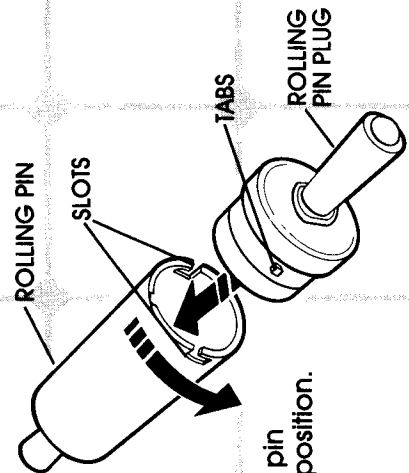

HELPFUL HINT: If the large pan becomes uneven, have an adult fill it with hot water and let it sit on a hard, flat surface for twenty minutes.