



**PLEASE KEEP THIS GUIDE AND ALL LITERATURE FOR FUTURE REFERENCE**

## PARTS DIAGRAM

Please check all parts carefully before assembly.



## ADULT ASSEMBLY REQUIRED

Phillips screwdriver needed for assembly (not included).

**CAUTION:** This product contains small parts which are necessary for assembly. Prior to and during assembly of this product, keep small parts out of children's reach. Small parts pose a choke hazard to children under 3 years.

**ADULTS PLEASE NOTE:** Periodically check all hardware to be sure it is secure. Please read instructions prior to assembly. Study each step carefully to familiarize yourself with procedure and parts. Refer to diagram for illustrated parts list. For easier assembly, trim excess plastic from all parts before starting.

## GOLF BAG ASSEMBLY

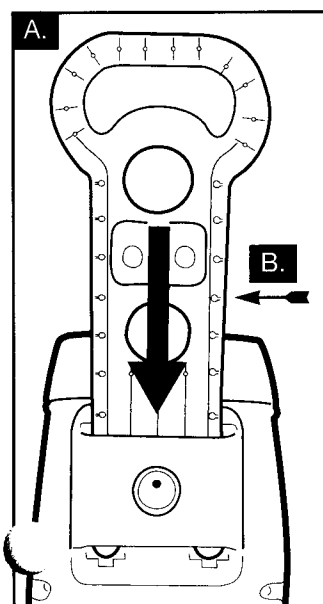

- A. Place golf bag assembly flat down in front of you on a table as shown.
- B. Push handle down into fitting as shown, until it snaps firmly into position.
- C. Secure handle with a 1/2" screw and a Phillips screwdriver.

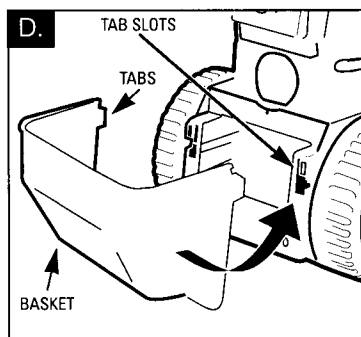
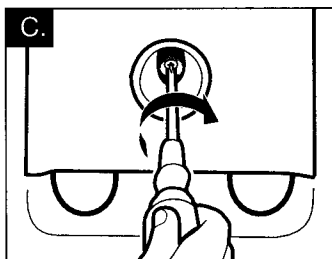

- D. Attach golf ball basket to bottom rear of golf bag assembly.
- E. Place basket tabs into slots as shown. Push basket up into place to line up with screw holes.
- F. With basket in place and screw holes lined up, secure the assembly with two 1/2" screws as shown.

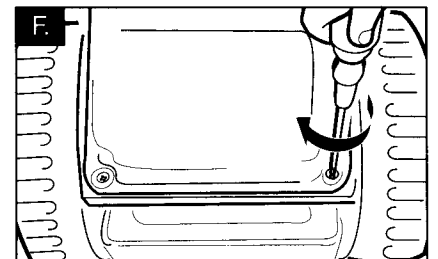
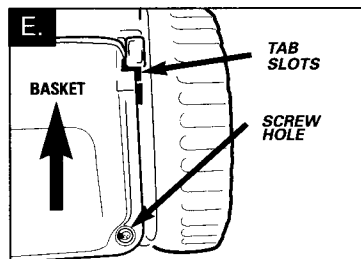

# PLAY INSTRUCTIONS:

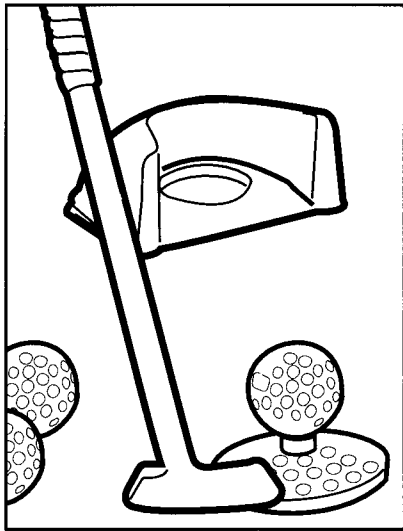

Your preschooler is ready to "hit the links!" The Pick Up 'n Play Golf Set comes with lots of fun golfing accessories, including a driver, putter, ball tee, putting cup and 3 golf balls. Your child can tee it up and practice driving, or practice putting with the putter and cup!

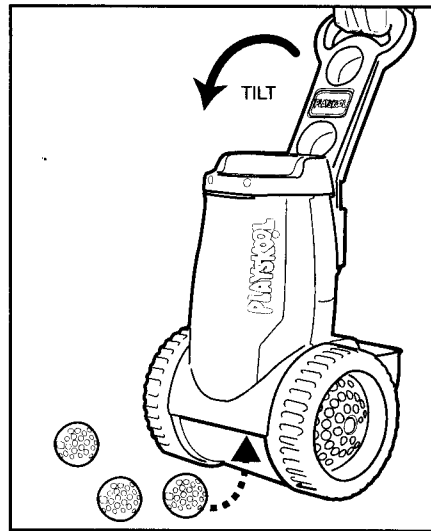

The golf bag picks up the golf balls as it rolls! Just hold the handle and roll the bag (in forward motion only) over the golf balls, and it will scoop them up into the ball basket. Tilt the bag slightly forward when scooping balls; if the basket is "dragging" along the ground, the pick-up mechanism may not work properly.

**Parents:** Initially, you may have to show your preschooler how to tilt the bag properly.

**Note:** The Pick Up 'n Play Golf Set is designed for both indoor and outdoor play. The pick-up action will work on floors, carpets and short grass. If the grass is high, it may jam the scooping mechanism.

# AFTER PLAY

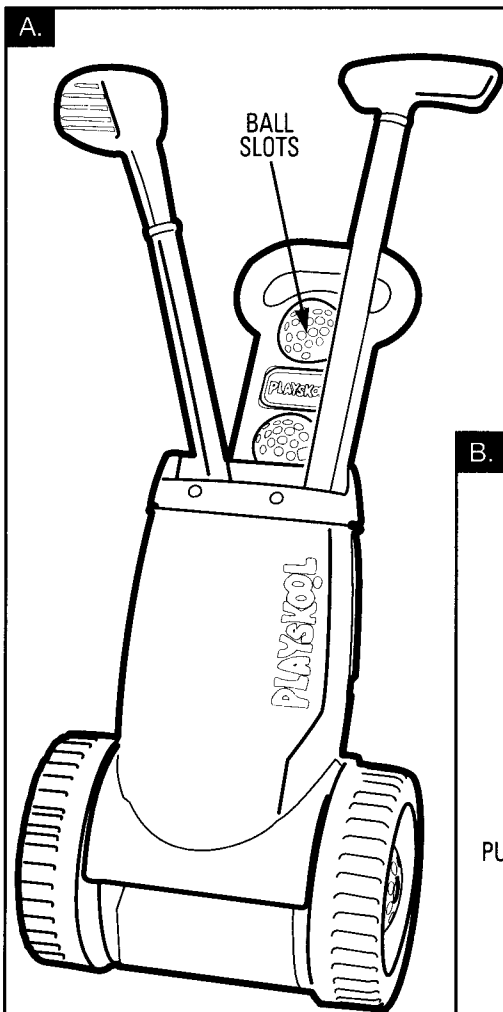

When your child is finished playing, all the accessories store neatly on the golf bag: the driver and putter inside the bag; the ball tee behind the handle; the putting cup on top of the ball basket; and the handle has slots for 2 of the 3 golf balls (see illustration A), or they can be stored in the ball basket (illustration B).

