

SUPER POO-CHI

Your Interactive Dog!

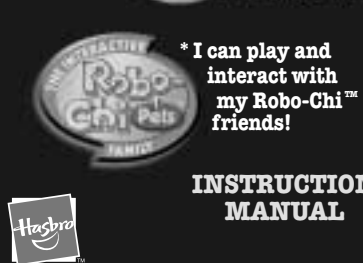

* I can play and interact with my Robo-Chi™ friends!

INSTRUCTION MANUAL

Super Poo-Chi™ Care and Play Guide

Congratulations, you now have a special new friend. Super Poo-Chi™ is a super smart, super fun pal who loves to play! Because Super Poo-Chi is so smart, he can learn to respond to your voice and actually do tricks! But this is only the beginning. **Please carefully review the Play Guide and Care Guide for Super Poo-Chi before you start playing so you will be able to have loads of fun with your new friend!**

1. Getting started

Before we start you need to get to know about Super Poo-Chi's sensors. Super Poo-Chi's sensors include:

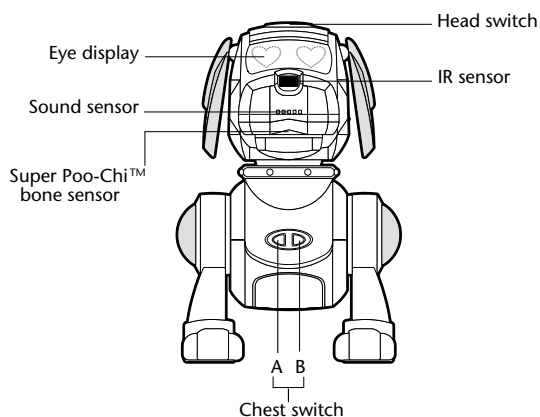

- Head switch:** used to wake up Super Poo-Chi, praise him or, pet him.
- Sound sensor:** used to receive voice commands, to hear other sound.
- Super Poo-Chi™ bone sensor:** used to feed him.
- Chest switches:** SET button (A) and MODE button (B); also used for "bad puppy".
- IR sensor:** enables Super Poo-Chi to play with other Robo-Chi Pets.

In addition to his sensors, Super Poo-Chi has very expressive eyes so that you can tell how he is feeling by looking at them:

Function of Eyes

heart	-	very happy
smile	-	happy
circle	-	waiting to call name
anger	-	normal
??	-	not happy
	-	waiting for voice command or judgement for proper reply or not.

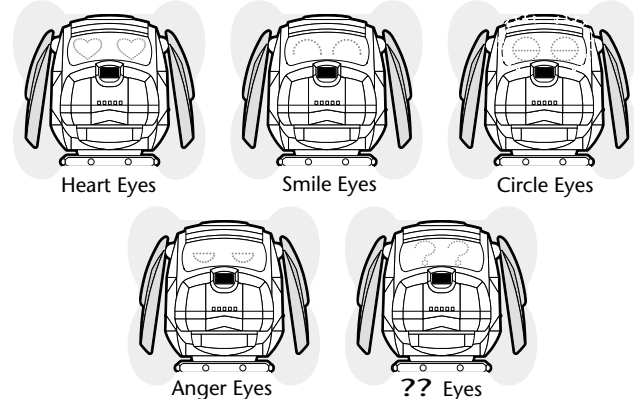

2. How to install batteries

Have an adult carefully loosen the screws on the battery door and then install 3 "C"/LR14 size batteries. Be especially careful to install the batteries in the correct direction according to the positive (+) and negative (-) signs on the batteries.

1. Unscrew and remove the battery compartment door under Super Poo-Chi's navel.
2. Insert 3 "C"/LR14 batteries as shown inside the battery compartment.
3. Attach the battery compartment door and fasten the screw.
4. Press the **RESET** button located inside Super Poo-Chi's mouth (see **RESET** section for more details).

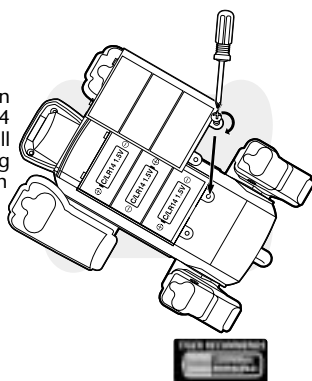

When replacing with new batteries, please install after Super Poo-Chi goes into a deep sleep.

* Do not dispose of batteries in fire, batteries may explode or leak.

To ensure proper function:

- Do not mix old and new batteries.
- Do not mix alkaline, standard or rechargeable batteries.
- Battery installation should be done by adult.
- Non-rechargeable batteries are not to be recharged.
- Rechargeable batteries are to be removed from the toy before being charged (if removable).
- Rechargeable batteries are only to be charged under adult supervision.
- Only batteries of the same or equivalent type as recommended are to be used.
- Batteries are to be inserted with the correct polarity.
- Exhausted batteries are to be removed from the toy.
- The supply terminals are not to be short-circuited.

Replace with new batteries at the first sign of erratic operation.

When the batteries are correctly installed, Super Poo-Chi will beep continuously to let you know he is ready to start. You then hit his head switch to begin training.

3. Teaching Super Poo-Chi™ with your voice

Once the batteries are installed the first thing you need to do is teach Super Poo-Chi to recognize your voice. Super Poo-Chi has an advanced Voice Recognition system that allows him to learn to respond to your commands. He will not be able to respond to voice commands unless he first learns your voice.

It is very important that when you teach Super Poo-Chi to recognize your voice, that you do it in a quiet room without any background noise or distractions. This means that the TV should not be on and other people should not be talking while you are doing the training. This will make sure that you properly train Super Poo-Chi to recognize your voice.

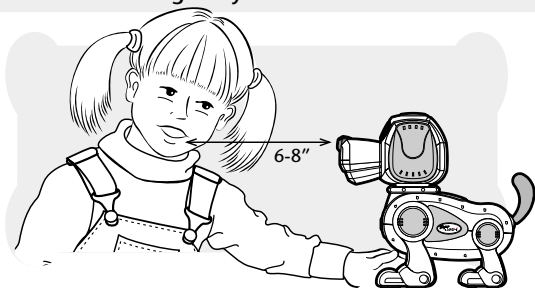

To train Super Poo-Chi to recognize your voice, position yourself directly in front of Super Poo-Chi approximately 6-8" apart, as shown in this illustration.

1. After the batteries are installed, Super Poo-Chi will beep continuously.
2. To begin voice training, press the head switch on Super Poo-Chi.
3. Super Poo-Chi will then issue a series of prompts asking you to say each of the commands you will need to train Super Poo-Chi to be able to recognize.

To train Super Poo-Chi to recognize your voice follow these steps:

First you give your Super Poo-Chi a name

- A. Super Poo-Chi will say "Say a name".
- B. Speaking clearly, say the name you want give your new friend.
- C. Super Poo-Chi will ask you to repeat the name, clearly repeat the same name you just said.
- D. If you have done this properly, Super Poo-Chi will beep and go to the next prompt, otherwise he will ask you to repeat the name again.

Next, you train Super Poo-Chi to recognize specific commands:

- PAW -

- A. Super Poo-Chi will prompt you to say "PAW".
 - B. Super Poo-Chi will then prompt you to repeat "PAW".
 - C. If you have done this correctly then Super Poo-Chi will beep and proceed to the next prompt.
 - GOOD DOG -
 - D. Super Poo-Chi will prompt you to say "GOOD DOG".
 - E. Super Poo-Chi will then prompt you to repeat "GOOD DOG".
 - F. If you have done this correctly then Super Poo-Chi will beep and proceed to the next prompt.
 - LET'S SING -
 - G. Super Poo-Chi will prompt you to say "LET'S SING".
 - H. Super Poo-Chi will then prompt you to repeat "LET'S SING".
 - I. If you have done this correctly then Super Poo-Chi will beep and proceed to the next prompt.
 - LIE DOWN -
 - J. Super Poo-Chi will prompt you to say "LIE DOWN".
 - K. Super Poo-Chi will then prompt you to repeat "LIE DOWN".
 - L. If you have done this correctly then Super Poo-Chi will beep and proceed to the next prompt.
 - SIT -
 - M. Super Poo-Chi will prompt you to say "SIT".
 - N. Super Poo-Chi will then prompt you to repeat "SIT".
 - O. If you have done this correctly then Super Poo-Chi will beep and proceed to the next prompt.
- Now you have trained Super Poo-Chi to recognize your voice.

4. Getting Super Poo-Chi™ to respond to voice commands

Once you have taught Super Poo-Chi to recognize your voice he is ready to start responding to your commands. To give voice commands to Super Poo-Chi follow these steps:

- 1) Wait until Super Poo-Chi has stopped moving and has circle eyes.
- 2) Speaking clearly call out Super Poo-Chi's name, therefore if you have named your dog "Spot" call out "Spot".
- 3) If you dog recognizes his name, his eyes will show "??" and he will say "huh".
- 4) While his eyes show "??" you can give him a command from the list, (PAW, GOOD DOG, LET'S SING, LIE DOWN, SIT).

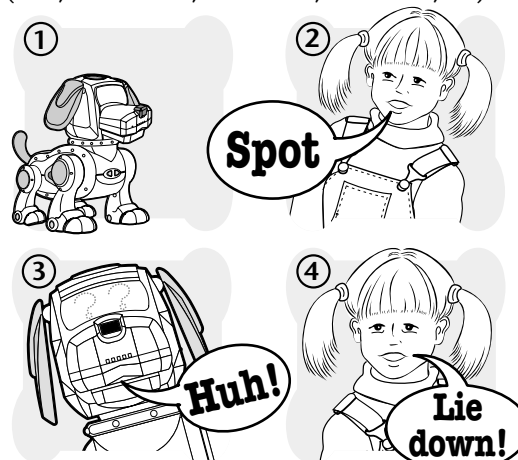

Depending on the stage of development your dog is in and how well you have trained him will determine if he behaves properly and performs the trick you have told him to do. Remember, if Super Poo-Chi responds correctly to your commands, reward him with a pat on the head or feeding him his bone. If he does not respond correctly, press either chest button. This will help him to remember his mistakes.

SUPER POO-CHI WILL NOT RESPOND TO ANY VOICE COMMANDS UNLESS YOU FIRST SAY HIS NAME TO GET HIS ATTENTION. THEREFORE IF YOU WANT YOUR DOG TO GIVE A PAW, YOU HAVE TO SAY HIS NAME FIRST, WAIT UNTIL HIS EYES SHOW "??" AND THEN SAW "PAW". IF YOU DO NOT SAY HIS NAME FIRST, HE WILL NOT PROPERLY RESPOND TO OTHER COMMANDS.

5. Stages of development

Super Poo-Chi will go through 3 stages of development, Baby, Puppy and Adult. In the Adult stage, Super Poo-Chi will become a Faithful dog, Talented dog or Lazy dog. Just like a real dog, how you train and play with Super Poo-Chi will determine how he develops!

You can actually choose how you want Super Poo-Chi to develop. You have 2 choices, Nourish mode or Adult mode. In Nourish mode, you get to train your Super Poo-Chi to do tricks. In Adult mode, your Super Poo-Chi will automatically know how to do all his tricks. In both modes your voice commands Super Poo-Chi to do his tricks.

To enter Nourish mode, press Super Poo-Chi's (A) chest button within 4 seconds after completely training Super Poo-Chi to recognize your voice. To enter Adult-Faithful dog mode instead, after voice training immediately press (B) chest button until you hear a "BEEP" (approximately 4 seconds), then immediately press head switch for 4 seconds until you hear another "BEEP". You have to retrain Super Poo-Chi to recognize your voice one time.

If you do not press either chest button after voice training, Super Poo-Chi will automatically go into Nourish mode.

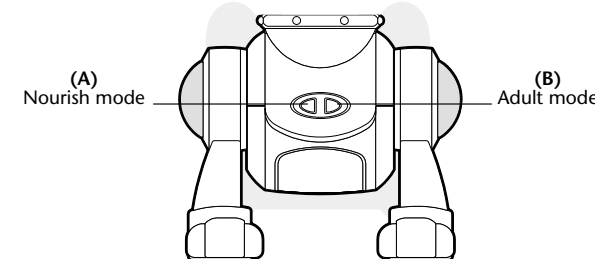

Press left chest (A) button to go to **Nourish mode**. Press right chest (B) button, then head switch button to go to **Adult mode**.

Nourish mode

There are three stages of development in Nourish mode Baby, Puppy, and Adult.

- Baby -

In the Baby stage Super Poo-Chi can not understand your voice commands very well.

Also he can not stand up for long time and is only able to sing one song.

In the Baby mode Super Poo-Chi will be able to respond to his name and may be able to do tricks.

- Puppy -

When Super Poo-Chi develops to Puppy mode, the "Tada" sound is heard and he will start to bark.

The puppy age is a very important development stage during which time Super Poo-Chi learns to do tricks by your voice commands. If you play a lot you will be able to teach Super Poo-Chi to do many things!

Teaching your dog tricks:

Using the trained voice commands you can teach your dog to respond to your commands properly. To do this follow these steps.

- 1) Say your dog's name.
- 2) When his eyes show "??" give him a command.
- 3) If he does what you want him to do you will then need to reward him. You can do this 3 ways:
 - a. say "good dog"
 - b. give him his bone
 - c. pat his head

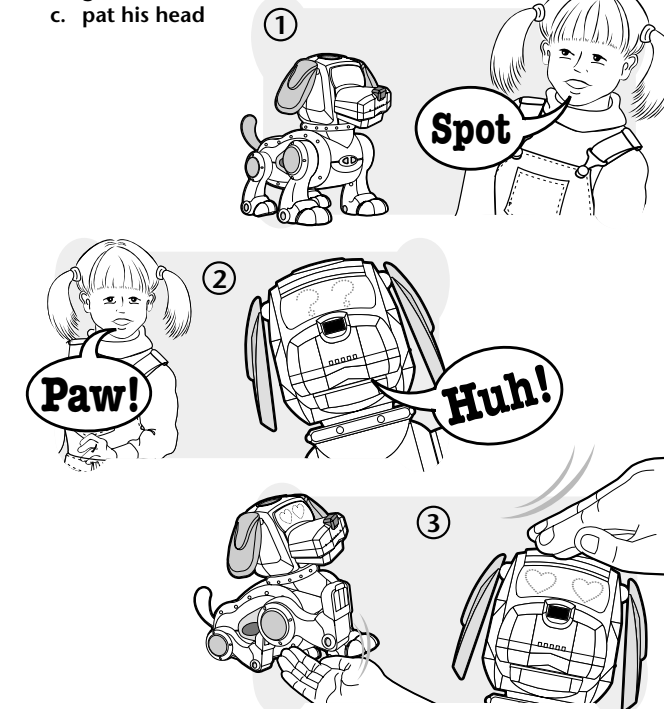

It is very important that you reward your dog for doing tricks properly or he will not learn to do them on command.

Repeating the above learning procedure allows your dog to learn more. But like any friend, play is important too and your dog also needs a break from his training. Play with your dog to give Super Poo-Chi a break and relax. Playing also is very important for Super Poo-Chi to develop his own personality.

Adult

As a result of his learning during puppy age, your dog will become one of three (3) different types of dog: Lazy dog, Faithful dog, or Talented dog.

- Lazy dog -

If you do not train your dog to properly respond to your voice commands he will become a lazy dog as an adult. If your dog becomes a lazy dog, he will have vague (confused) reaction to your voice commands.

- Faithful dog -

If you train your dog well during Puppy stage he will become a Faithful dog. A Faithful dog will properly respond to voice commands most of the time.

- Talented dog -

If you train your dog well as a puppy and play with him a lot during training he will become a talented dog. A Talented dog will respond properly to almost all of your voice commands and will be able to sing lots of songs and dance a lot.

In order to make sure your dog becomes a talented dog, it is very important that you command your dog to sing. Therefore be sure to use the voice command "Let's sing" while playing with your dog as he develops to make sure he becomes a talented dog.

Training hints:

If you do not teach and play with Super Poo-Chi much as a puppy your dog will become a lazy dog.

If you teach your dog a lot but do not play during training he will become a faithful dog.

If you teach your dog a lot and play with him during training he will become a talented dog.

6. Super Poo-Chi™'s Emotions and Expressions

Your Super Poo-Chi communicates with you with voice, his eyes and his animation. Watching these signals helps you know how your dog is feeling.

Very happy	flashing heart shape eyes
happy	flashing smile eyes, barking
normal	flashing circle eyes
bad mood	flashing anger eyes and growling
lazy mood	yawn
well fed	burp

7. How to feed your dog

Super Poo-Chi likes his bone very much. To make sure he is well fed and happy, give him his bone when he's hungry. You may also give Super Poo-Chi his bone when he is in a bad mood or to praise him during training, however if you feed Super Poo-Chi his bone too often he will not like it.

To feed him his bone

Hold his bone to his mouth as shown in the illustration.

If he is hungry he will make slurping sounds. If he is not hungry he will not. Remember if you feed him too much he will become unhappy!

WARNING: Super Poo-Chi's bone is a toy. Bone is not intended for use by a live dog.

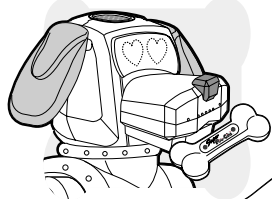

8. Sleeping mode

If you leave Super Poo-Chi alone without any communication (input voice command, touch, etc) for 3 minutes he will take a nap for 1 min. If you leave Super Poo-Chi alone even longer than 2 minutes, he will go into a deep sleep.

Press his head button to wake him up.

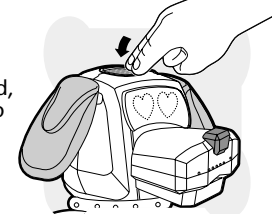

9. Recover

If when you replace Super Poo-Chi's batteries or if he does not make any action, press the Recover (Reset) switch, which is located inside of upper jaw.

RESET BUTTON

10. Restart

If you want to start Super Poo-Chi all over again you may re-start Super Poo-Chi as a puppy or an adult:

- 1) To re-start as an adult press and hold the "B" 4 seconds, until Super Poo-Chi rapidly beeps, then press and hold the head switch 4 seconds until it rapidly beeps again. At that point you will be prompted to retrain the recognition sets.
- 2) To re-start as a puppy press and hold the "A" button 4 seconds, until Super Poo-Chi rapidly beeps, then press and hold the head switch 4 seconds until it rapidly beeps again. At that point you must also retrain the recognition sets.

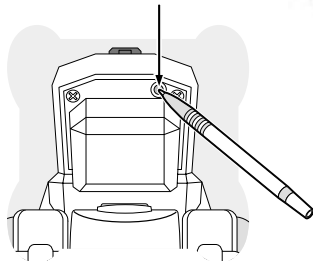

11. Secret Mode

If you want to get into the "secret mode", which plays all the songs Super Poo-Chi knows in a row without dancing, press the SET button (A) on his chest for 4 seconds and it will begin beeping. Then press the MODE button (B) and it will play the first song. If you press the HEAD button, it stops that song and you can then press the MODE button (B) to go to the next song. If you press the SET button (A) again, it exits the secret mode.

Retrain 1 word at a time:

If you want to retrain one or two of your commands, you don't have to erase them all and start over. You can press the MODE button for 4 seconds and it will begin beeping. Then hit the SET button to enter the retrain mode. Then hit the MODE button again to step through the commands, which are indicated by the eye patterns:

Function of Eyes for retraining:

heart	paw
smile	good dog
circle	lie down
anger	let's sing
? ?	"name"
heart/anger together	sit

After you find the one you want to retrain, hit the SET button and it will prompt you to train the word. After you're done, hit the MODE button again until you return to normal gameplay. You should get a "BEEP" after you're done and the dog will bark.

12. IR Communication

If you put 2 Super Poo-Chi's together or 1 Super Poo-Chi and 1 Poo-Chi™, they will "talk" to each other. In order to get them to communicate, place them facing each other about 12-16" apart, then touch their head switches at the same time. Super Poo-Chi should always be standing when you want him communicate. They will then "talk", and based on how happy they are, they will do different actions. 2 happy dogs will sing to each other, 1 happy and 1 unhappy will just say "hi", and 2 unhappy dogs will fight.

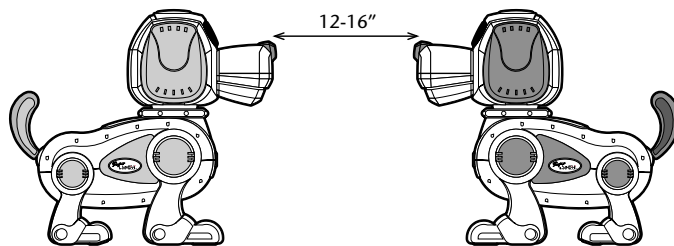

Depending on his development and mood, Super Poo-Chi might not interact with other dogs or pets all the time, the happier they are, the more they like to interact! Also, if the 2 dogs have been communicating for a while, sometimes the dogs don't have to be facing each other or have been commanded to talk. The "talking" signals will bounce off of the walls, so sometimes they may talk to each other "spontaneously".

13. Cleaning Instructions

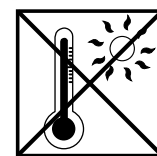

High temperature will destroy the unit. Do not leave unit in direct sunlight.

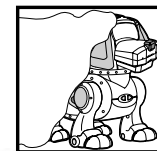

Clean only with a piece of soft dry cloth.

14. Troubleshooting

Super Poo-Chi is designed to provide hours of fun play. If Super Poo-Chi becomes erratic and you are having trouble, check to make certain that Super Poo-Chi has fresh batteries and then call Tiger Electronics' Customer Service Department at 1-800-844-3733.

If you can't see Super Poo-Chi's eyes, he may be asleep (see section titled "SLEEPING") or check to make certain there are fresh batteries.

You can wake up Super Poo-Chi by pressing the head sensor. If Super Poo-Chi was sad when he fell asleep, it may take multiple head presses to wake up Super Poo-Chi. If Super Poo-Chi was happy when he fell asleep, it will be easier to wake up Super Poo-Chi.

To wake up Super Poo-Chi when he is snoring, hold his special bone in front of his mouth or press his head button.

For more information about Tiger Electronics, our products and special promotions, please visit our web site at: www.tigertoys.com.

15. 90-Day Limited Warranty

Tiger Electronics, Ltd. (TIGER) warrants to the original consumer purchaser of this product that the product will be free from defects in materials or workmanship for 90 days from the date of original purchase. This warranty does not cover damages resulting from accident, negligence, improper service or use or other causes not arising out of defects in materials or workmanship.

During this 90-day warranty period, the product will either be repaired or replaced (at TIGER'S option) without charge to the purchaser, when returned with proof of the date of purchase to either the dealer or to TIGER.

Product returned to TIGER without proof of the date of purchase or after the 90-day warranty period has expired, but prior to one year from the original date of purchase, will be repaired or replaced (at TIGER'S option) for a service fee of US\$25.00. Payments must be by check or money order payable to Tiger Electronics, Ltd.

THE FOREGOING STATES THE PURCHASER'S SOLE AND EXCLUSIVE REMEDY FOR ANY BREACH OF WARRANTY WITH RESPECT TO THE PRODUCT.

All product returned must be shipped prepaid and insured for loss or damage to:

TIGER REPAIR DEPARTMENT
1000 N. Butterfield Road, Unit 1023
Vernon Hills, IL 60061, U.S.A.

The product should be carefully packed in the original box or other packing materials sufficient to avoid damage during shipment. Include a complete written description of the defect, a check if product is beyond the 90-day warranty period, and your printed name, address and telephone number.

THIS WARRANTY IS IN LIEU OF ALL OTHER WARRANTIES AND NO OTHER REPRESENTATIONS OR CLAIMS OF ANY NATURE SHALL BE BINDING ON OR OBLIGATE TIGER IN ANY WAY. ANY IMPLIED WARRANTIES APPLICABLE TO THIS PRODUCT, INCLUDING WARRANTIES OF MERCHANTABILITY AND FITNESS FOR A PARTICULAR PURPOSE, ARE LIMITED TO THE NINETY (90) DAY PERIOD DESCRIBED ABOVE. IN NO EVENT WILL TIGER BE LIABLE FOR ANY SPECIAL, INCIDENTAL, OR CONSEQUENTIAL DAMAGES RESULTING FROM POSSESSION, USE, OR MALFUNCTION OF THIS TIGER PRODUCT.

Some states do not allow limitations as to how long an implied warranty lasts and/or exclusions or limitations of incidental or consequential damages, so the above limitations and/or exclusions of liability may not apply to you. This warranty gives you specific rights, and you may also have other rights which vary from state to state.

This device complies with Part 15 of the FCC Rules. Operation is subject to the following two conditions:

- (1) this device may not cause harmful interference, and (2) this device must accept any interference received, including interference that may cause undesired operation.

Warning: Changes or modifications to this unit not expressly approved by the party responsible for compliance could void the user's authority to operate the equipment.

NOTE: This equipment has been tested and found to comply with the limits for a Class B digital device, pursuant to Part 15 of the FCC Rules. These limits are designed to provide reasonable protection against harmful interference in a residential installation. This equipment generates, uses, and can radiate radio frequency energy and, if not installed and used in accordance with the instructions, may cause harmful interference to radio communications. However, there is no guarantee that interference will not occur in a particular installation. If this equipment does cause harmful interference to radio or television reception, which can be determined by turning the equipment off and on, the user is encouraged to try to correct the interference by one or more of the following measures:

- Reorient or relocate the receiving antenna.
- Increase the separation between the equipment and receiver.
- Connect the equipment into an outlet on a circuit different from that to which the receiver is connected.
- Consult the dealer or an experienced radio TV technician for help.

TIGER
ELECTRONICS
A division of Hasbro, Inc.



©, TM, & © 2000 Tiger Electronics. All Rights Reserved.
980 Woodlands Parkway, Vernon Hills, IL 60061, U.S.A.
©, TM, & © 2000 Tiger Electronics UK Ltd. All Rights Reserved.
Belvedere House, Victoria Avenue Harrogate, North Yorkshire, United Kingdom HG1 1EL.

© SEGA TOYS 2000
PRINTED IN CHINA

200002120IWT1-04