



# Bavarian Castle

## IMPORTANT NOTICE

All pieces with red dots are *not* part of your Puzz-3D. Set these pieces aside while you build your puzzle. Then discard them only when your puzzle is complete. Careful! Some unmarked pieces may remain interlocked with red-dot pieces. Also, some waste pieces are too small to be marked with red dots. Therefore, check these pieces thoroughly before discarding.

## Helpful Hints

- Increased handling of your Puzz-3D does create some static cling. Keep an eye on your surroundings and your sleeves while you are working.
- If you have pets, keep them away from the puzzle. They love to play with the foam pieces. The foam is non-toxic.

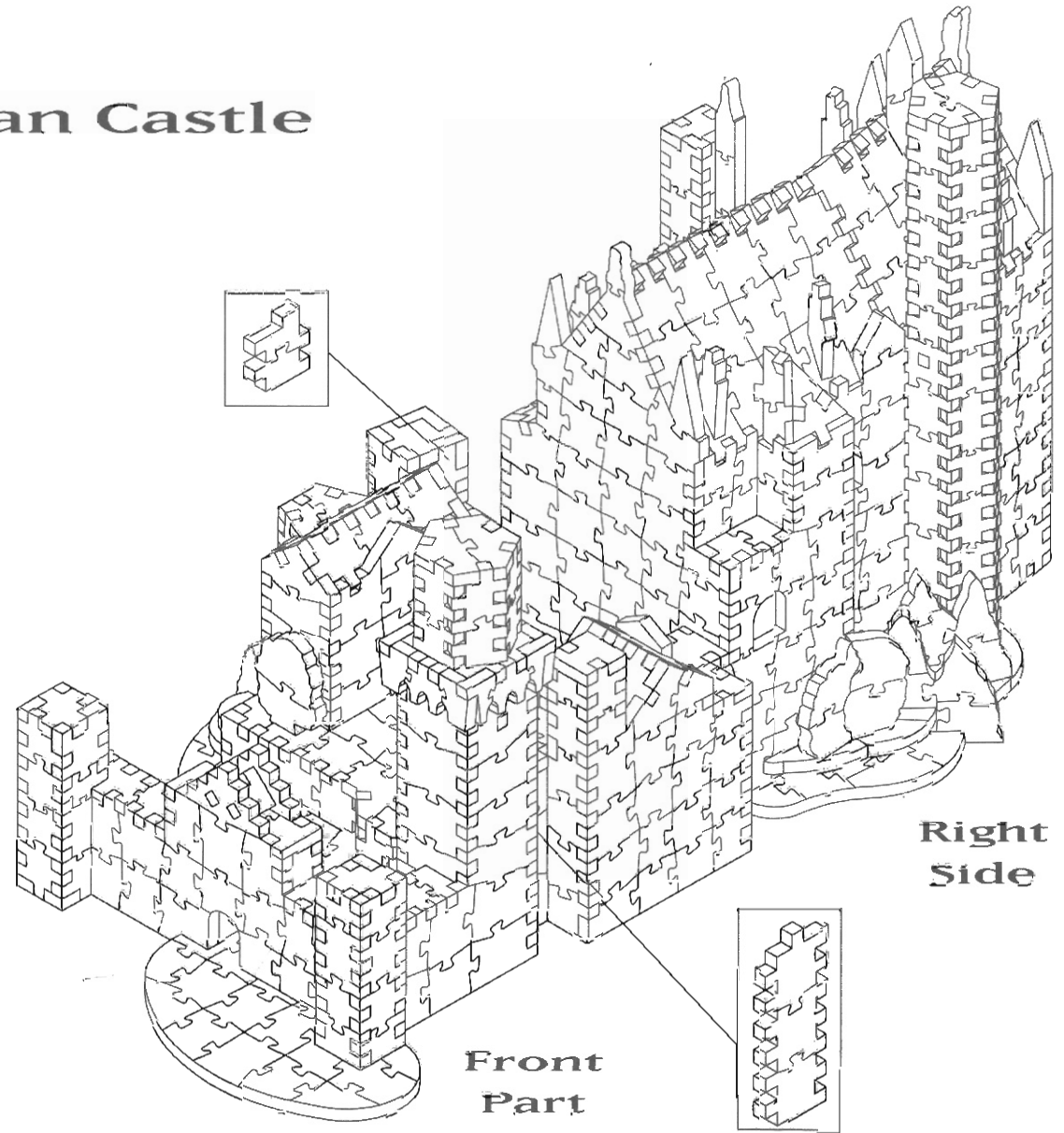
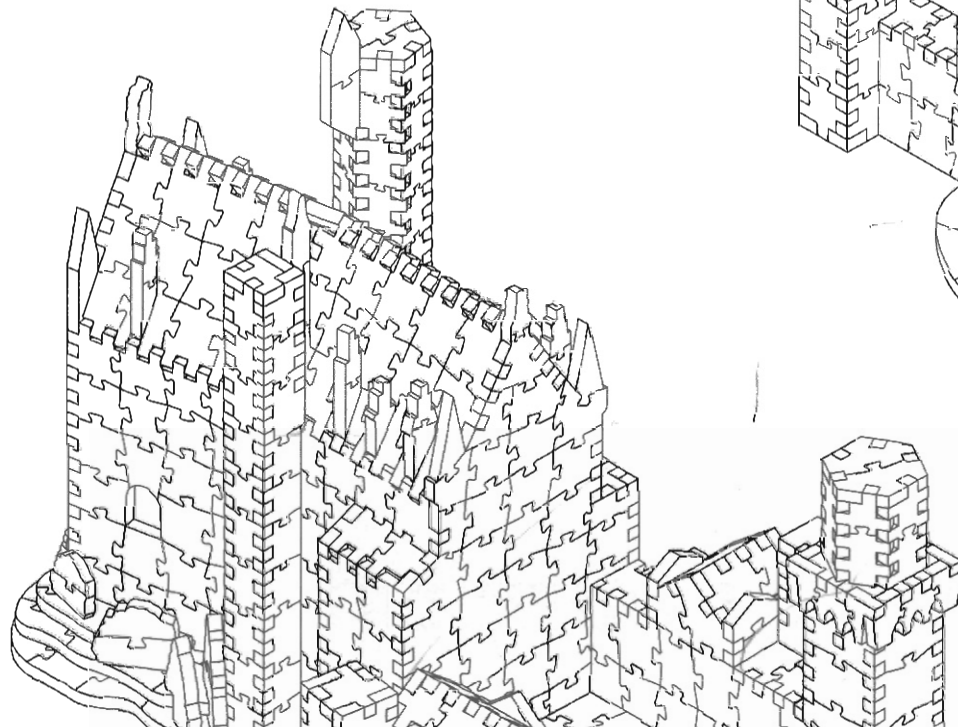

## Important Building Information

Vertical portions of your puzzle (such as walls) fit onto the horizontal portions (floors, rooftops, etc.) as shown in the illustrations below. You may find it easier to build the base of your puzzle first, then attach the puzzle wall pieces to the base.

Left Side

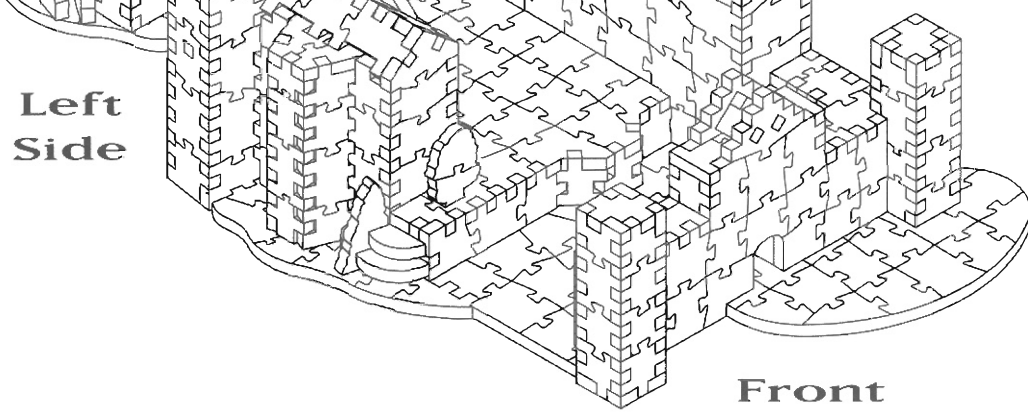

Front Part

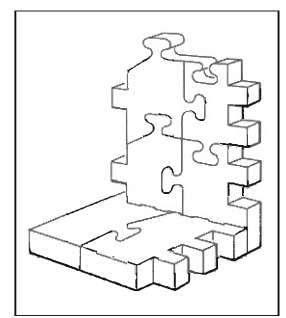
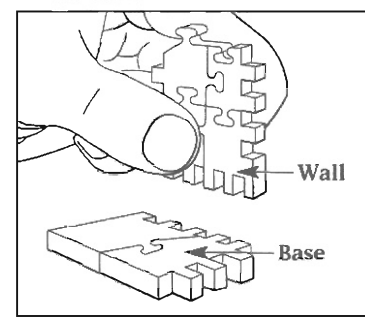

Remember to refer to the different views of the completed puzzle on the back of your box when working on those parts of your puzzle.

Right Side

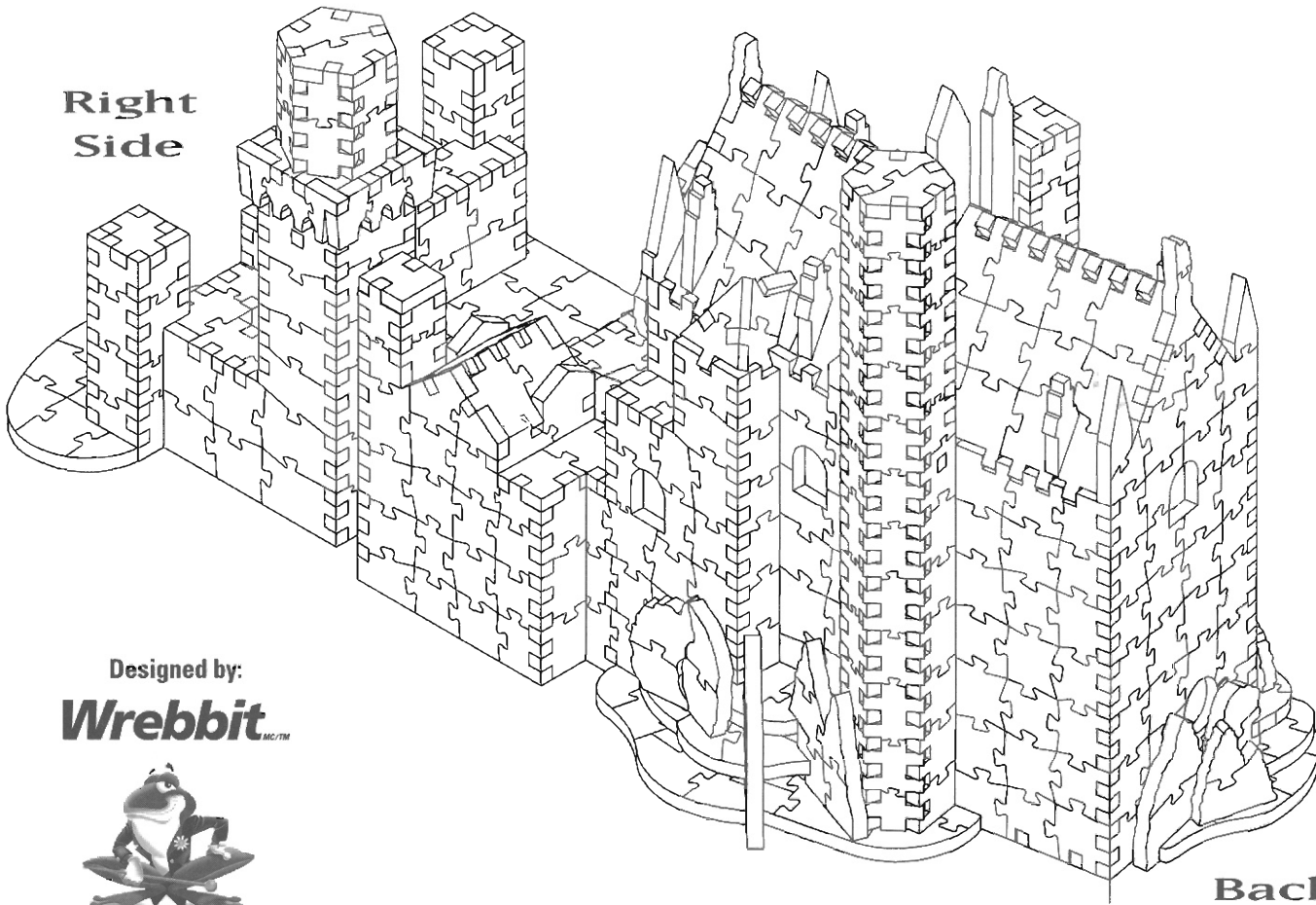

Back Part

Cardboard Roofs

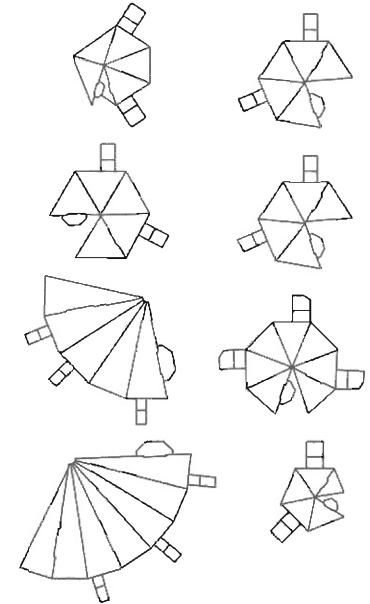

Designed by:  
**Wreabbit** INC./TM



Throne Room	
Singer's Hall	
Ludwig's Bedroom	
Royal Hall	
Supports	<p style="text-align: center;">support 1</p> <p style="text-align: center;">supports 2 &amp; 3</p>

## Front Courtyard

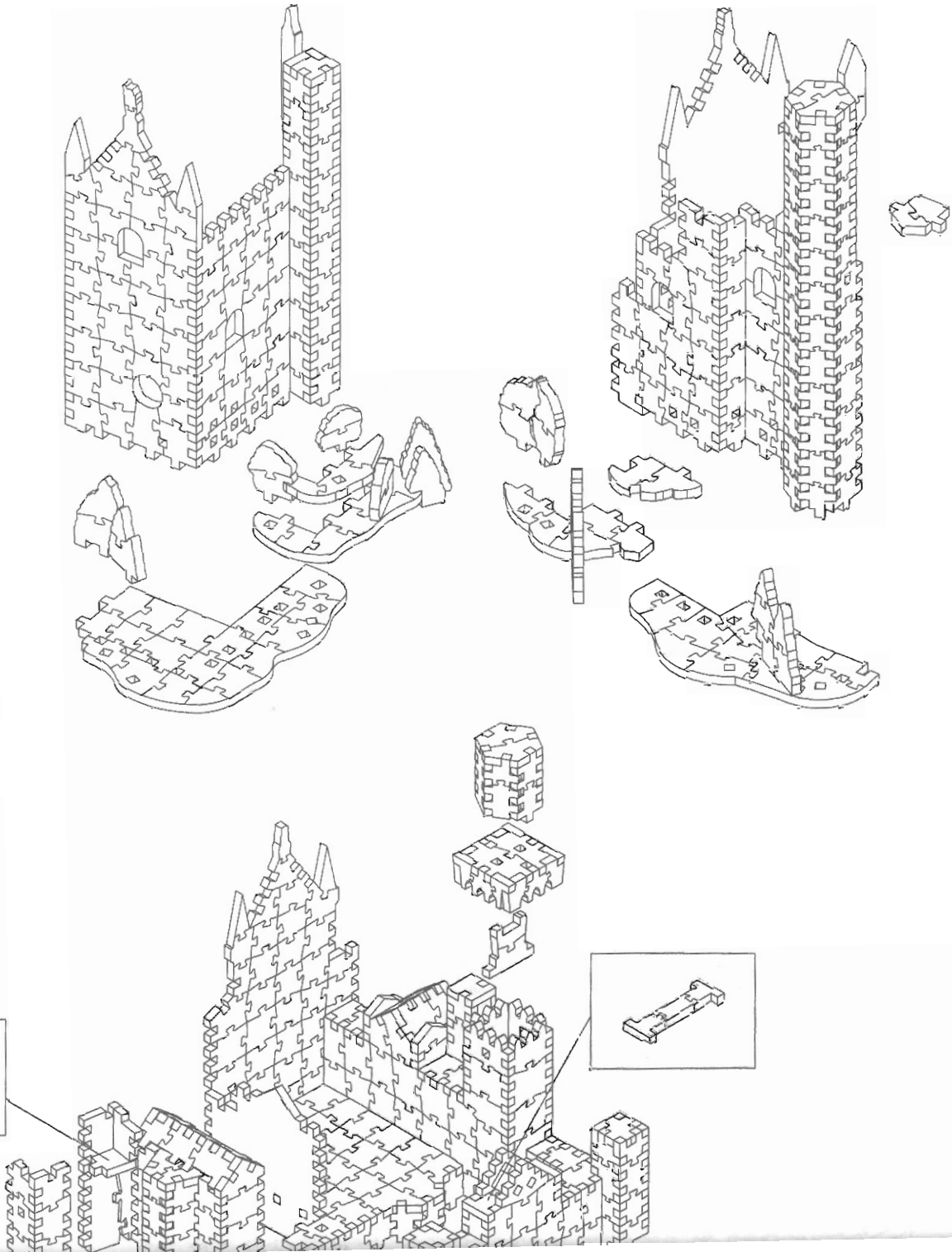
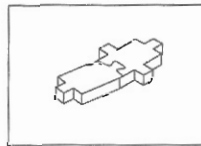
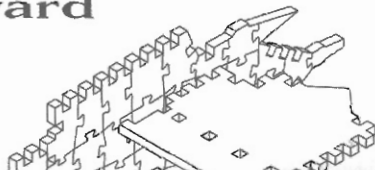

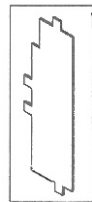

Support 4

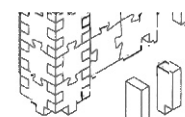
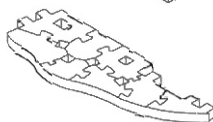
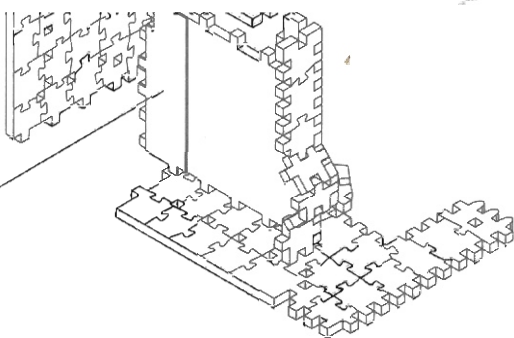

Part

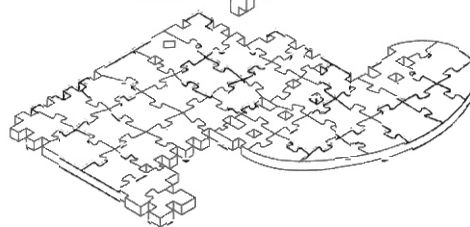

## Missing Puzzle Pieces

If a piece of your PUZZ-3D® is missing or damaged, we will replace it. Simply indicate on this puzzle guide sheet approximately where the problem is occurring. Then send this guide sheet with the area circled, along with your name, address and phone number to the address below.

If your puzzle's missing piece is not clearly shown in any of the drawings, in addition to circling the area, briefly describe which piece you need.

**Remember to check thoroughly through your bag of discarded pieces to determine if any puzzle pieces are still attached to red-dot pieces.**

Hasbro Games  
Consumer Affairs Dept.  
P.O. Box 200  
Pawtucket, RI 02862  
Tel: 888-836-7025 (toll-free).

Within 2 to 4 weeks you will receive the required piece(s).

Name \_\_\_\_\_

Address \_\_\_\_\_

City or Town \_\_\_\_\_

State \_\_\_\_\_ Zip \_\_\_\_\_

Phone Number \_\_\_\_\_

PUZZ-3D® is a trademark owned by 2798140 Canada Inc., and the distinctive design and elements of the PUZZ-3D® puzzles are used under license from Wrebbit Inc. by Hasbro.

The Happy Frog logo is a trademark owned by Wrebbit Inc. Copyright: Wrebbit Inc.

U.S. Patent No. 5251900

www.hasbro.com

The HASBRO name and logo are TM & ©1999 Hasbro. All Rights Reserved. 49041-X1

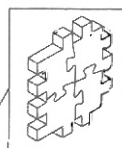

Left Side

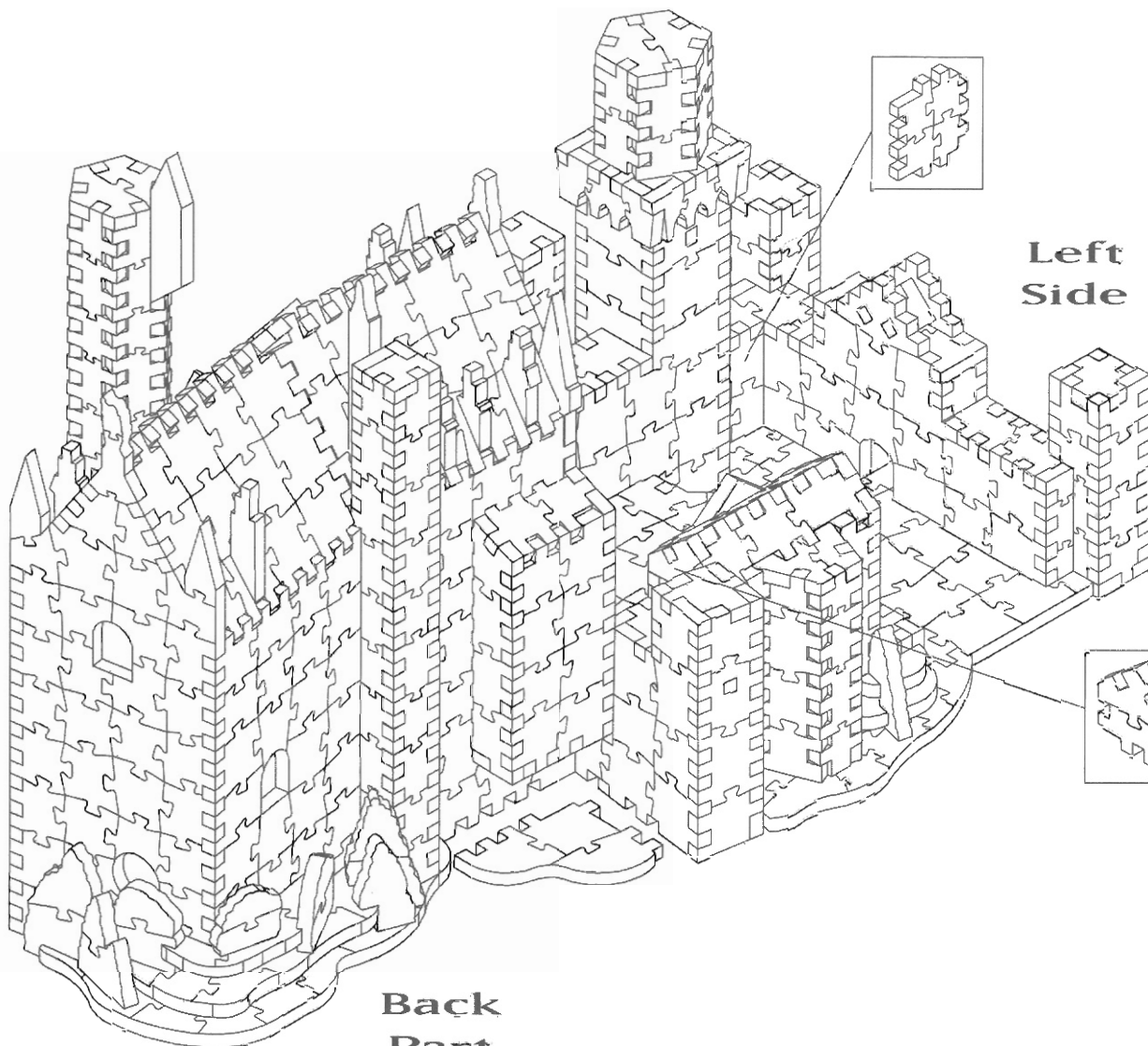

Back Part

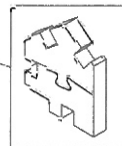

# ASSEMBLY INSTRUCTIONS FOR YOUR PUZZ-3D<sup>®</sup> ADVENTURE!



## 1 Remove and set aside waste pieces

Pieces with red dots on them are not to be used in your puzzle. Remove them from your bag of puzzle pieces and set them aside. Some are very tiny — about 1/4 inch square — and you will need to remove them from the inside of puzzle pieces. **DO NOT THROW AWAY ANY RED-DOT PIECES!**

Frequently, puzzle pieces are still attached to red-dot pieces and it's easy to miss them. For now, remove all the red-dot pieces and place them in a safe place, such as a zip-top plastic bag.



Various types of red-dot pieces

## 2 Examine the types of puzzle pieces

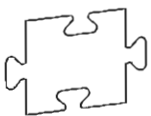

**Jigsaw:** These pieces have regular jigsaw cuts and are used in the middle of a wall or base. They are never used to create an edge or corner.

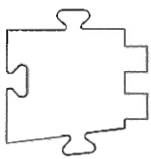

**Square:** These pieces have square cuts on one or more sides. They "dovetail" with pieces having the same type of edge to form an angle when they connect. These pieces create your puzzle's corners and are what make your Puzz-3D three-dimensional! A corner can be formed by connecting a base to a wall, a roof to a wall or a wall to another wall. See illustration.

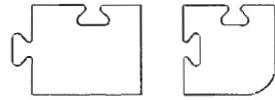
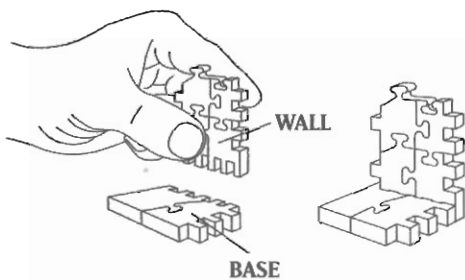

Straight edge      Curved edge

**Edge:** These pieces have one or two straight or curved edges. The outside edge of the base of your puzzle is made up of these, but they can also create an edge of another section, such as the top of a wall.

**Decorative:** The remainder of your pieces are decorative and are usually added at the end to complete your puzzle. An example would be the top of a tower.

## 3 Assemble the sections

Sort pieces according to color and design, then assemble them to form flat sections of your puzzle. Since your Puzz-3D is made from foam, it's much easier to mistakenly fit the wrong pieces together than it is with cardboard! When connecting pieces, be sure the artwork on the two pieces matches *perfectly*. Look for subtle color, shade and design differences between pieces. In most cases, a finished section will have its perimeter entirely made up of square cut pieces, as shown here. Some sections, however, may have one or more sides that are straight or curved.

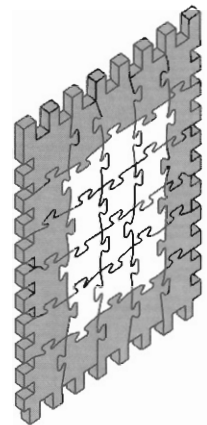

A completed section with square cut pieces in gray

## 4 Think vertical!

Remember, your puzzle is not just a *picture*, but a dimensional model! **The inside will be hollow.** The vertical walls attach to the horizontal base wherever each side consists of square cut edges. The base will be flat and the walls will go UP!

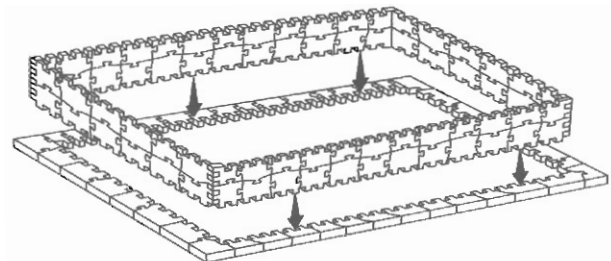

A sample of a base and wall

# Bavarian Castle

## THE TWO BASIC UNITS

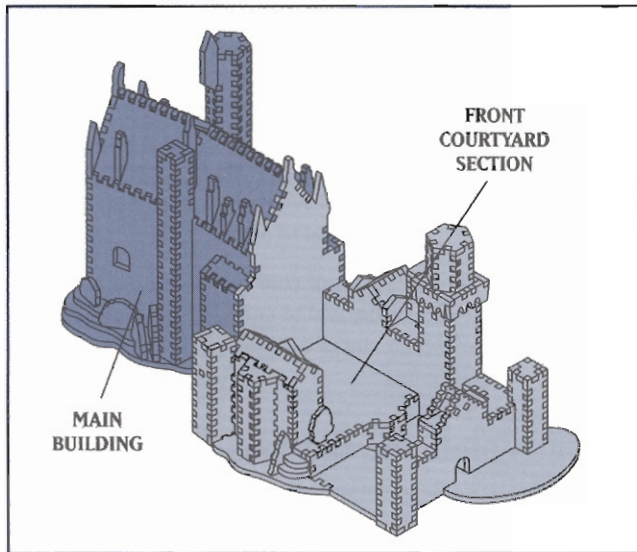

Refer to the illustration below for steps 5 and 6.

### 5 Begin the courtyard and front tower

Build the sections that make up the courtyard raised floor and the inside tower wall. Assemble as shown.

### 6 Attach the cardboard support and main building front wall

Assemble the pieces of the main building front wall and the left building inside wall. Attach to the courtyard raised floor along with the cardboard support. (Sub-assembly shown being assembled on its side.)

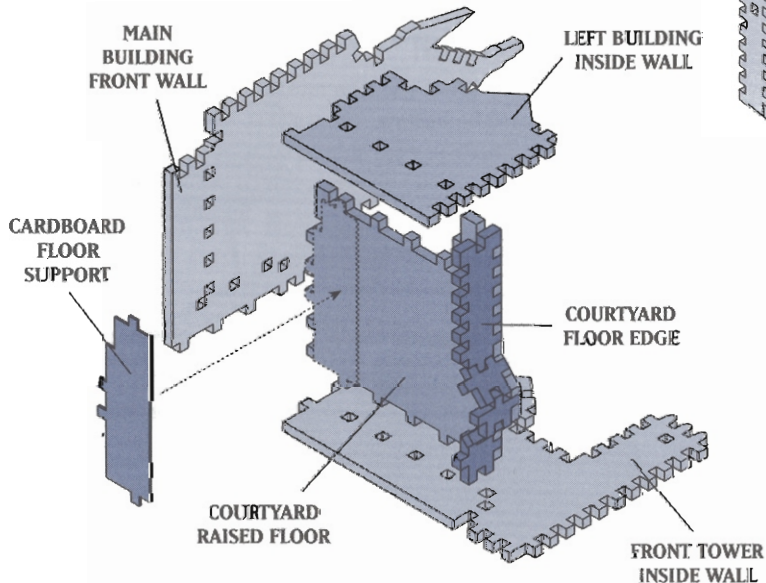

Refer to the illustration below for steps 7 and 8.

### 7 Add the entrance and outer walls

Build all the sections that make up the entrance to the castle and the front base. Attach as shown. Assemble the outer wall sections for the left building and the front tower building and attach to the outside of the main courtyard area.

### 8 Finish the front courtyard

Build and attach all the roof sections to the front buildings and add the top to the small front tower. Set aside the completed front courtyard section and begin the main building.

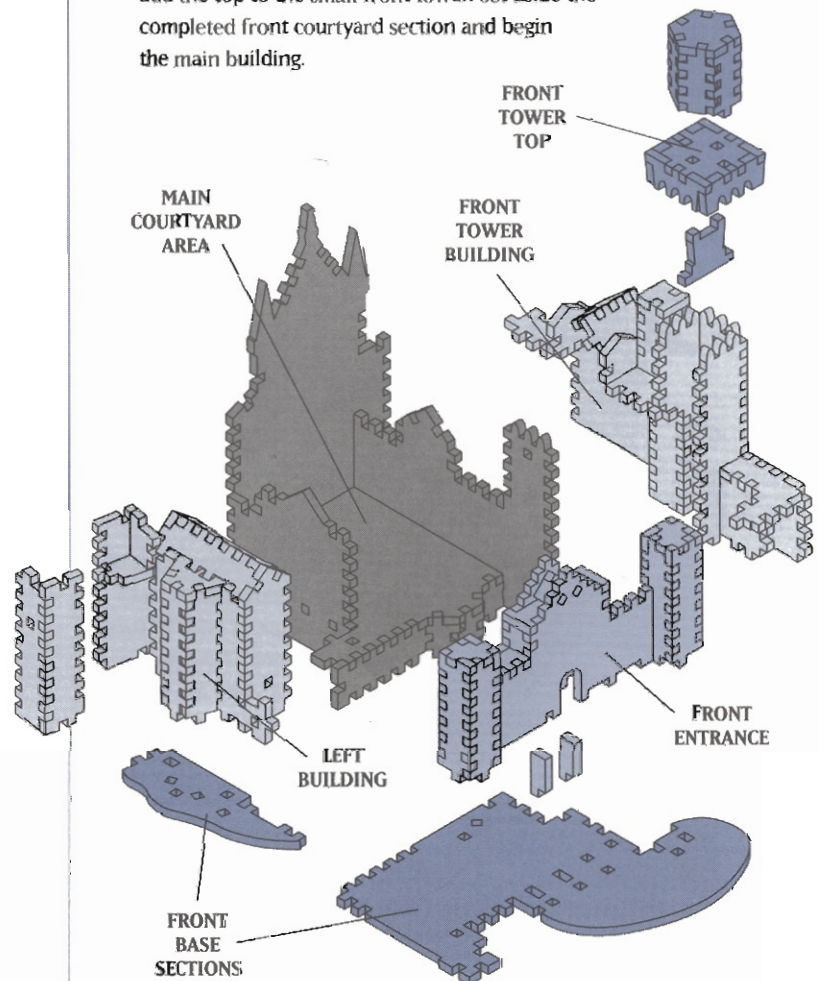

Use the photographs on the front and back of the box to locate the sections that are needed to complete each of the following steps.

Refer to the illustrations below for steps 9 through 11.

### 9 Construct the two flanking towers

Locate and build the sections that make up the tall lookout tower and the mid-sized tower of the main building. Attach the roofs and turrets of each.

### 10 Assemble the main building rampart walls

Build the remaining walls of the castle's main building. Link them together, and to the two flanking towers as shown. Pop out the four arched windows and the battery box switch hole at this time.

### 11 Fit the walls and towers to the cliffs

Assemble the pieces that make up the cliffs and trees at the back and right side of the castle. Attach these to the bottom of the main building as shown.

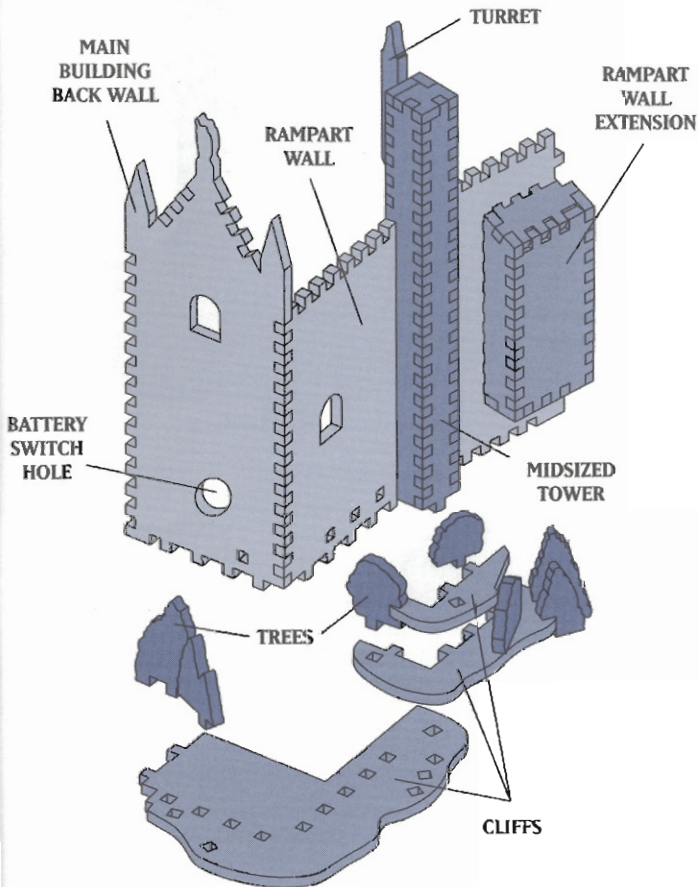

### 12 Fold the cardboard rooms and supports

Fold each room closed as shown on the separate technical sheet enclosed with your puzzle, fitting the tabs to the slots. Also fold support 1 and attach supports 2 and 3 to each other.

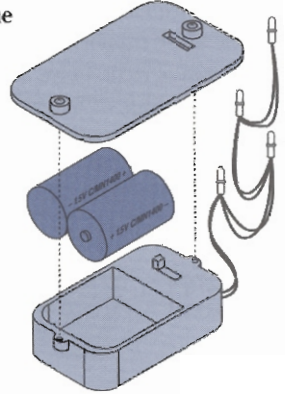

### 13 Install the batteries

Remove the battery box cover with a screwdriver and install two "C" size batteries as shown. Replace the cover and screw it back into place.

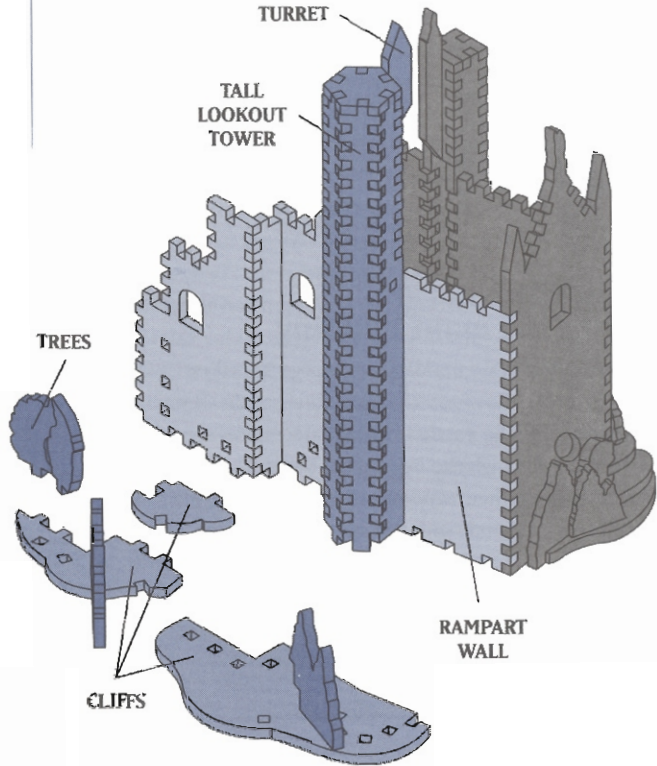

### CAUTION: To Avoid Battery Leakage

- Be sure to insert the batteries correctly and always follow the game and battery manufacturers' instructions.
- Do not mix old and new batteries, or alkaline, standard (carbon-zinc) or rechargeable (nickel cadmium) batteries.
- Always remove weak or dead batteries from the product.



First produced in 1991, this ingenious foam puzzle was the brainchild of Paul Gallant, the founder of Wrebbit Inc., a Canadian toy and game manufacturer. Today, Mr. Gallant and his talented staff offer a variety of PUZZ-3D designs, everything from famous landmarks to imaginary places.

## 14 Construct the castle interior

Insert each of the four light set bulbs into a punch hole in one of the three supports in the order shown at right. Place the rooms on top or inside of the supports, sliding the tabs down into the slots in front of the bulbs.

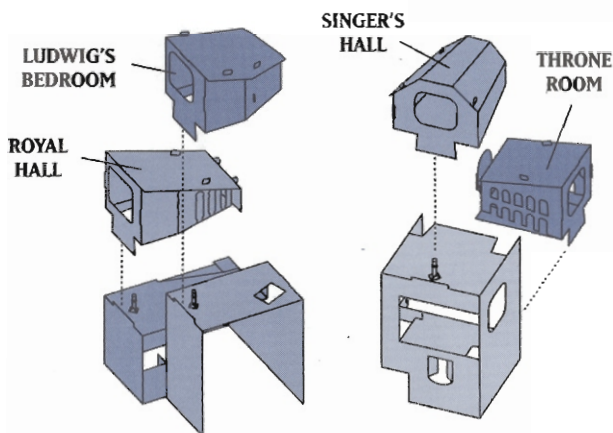
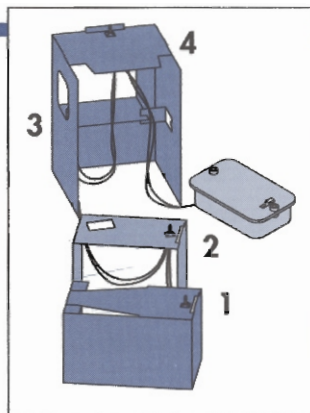

## 15 Put the interior into the main building

Place the assembled main building on a large board or cardboard. This will allow you to move your puzzle when it is completed. Slide the castle interior into the center of the main building through the open wall. Carefully line up the rooms with the arched windows in the rampart walls, and the battery box switch with the switch hole in the back of the castle. Test the switch at this point to make sure all the lights are lined up correctly.

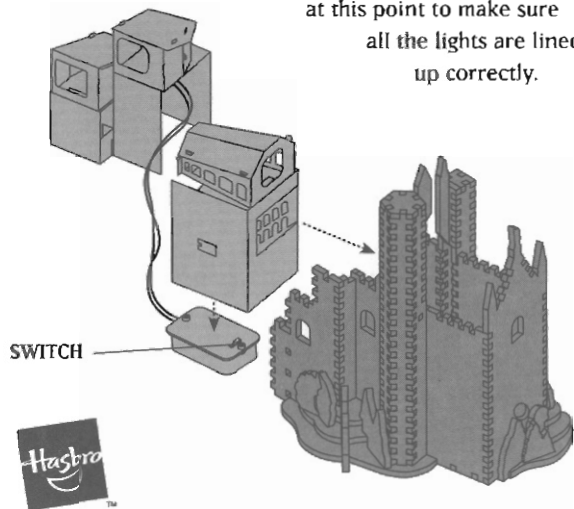

## 16 Complete the castle

Place the completed front section next to the main building and join together. Add the final small base piece that connects the two. Build the pieces that make up the roofs and chimneys of the main building. Close the top of the castle with these sections. Fold each pointed cardboard roof and fit its tabs under each topmost roof foam piece to hold it in place. You may have to remove each foam piece and replace it with the tabs underneath.

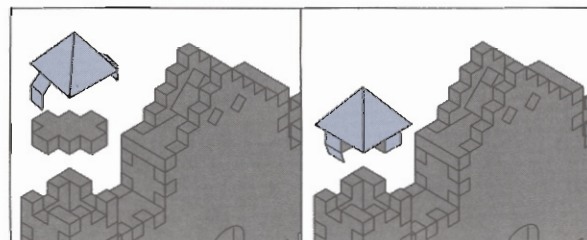
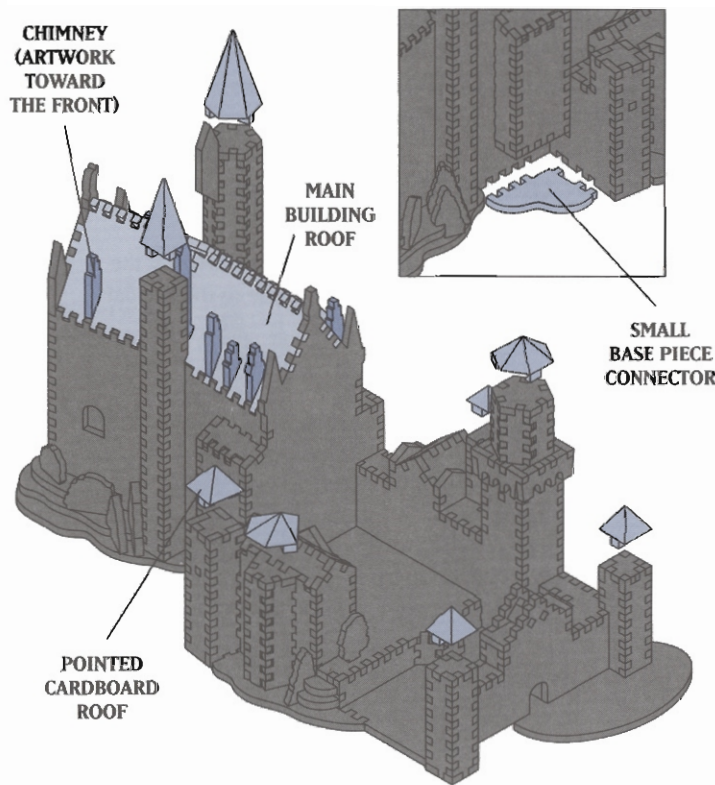

PUZZ-3D® is a trademark owned by 2798140 Canada Inc., and the distinctive design and elements of the PUZZ-3D® puzzles are used under license from Wrebbit Inc. by Hasbro. The Happy Frog logo is a trademark owned by Wrebbit Inc. Copyright: Wrebbit Inc. U.S. Patent No. 5,251,900

www.hasbro.com

The HASBRO name and logo are TM & ©1999 Hasbro, Pawtucket, RI 02862. All Rights Reserved. 49041-x2

