

Puzz 3D[®] Swallow Inn

Helpful Hints

- Increased handling of your PUZZ-3D[®] does create some static cling. Keep an eye on your surroundings and your sleeves while you are working.
- If you have pets, keep them away from the puzzle. They love to play with the foam pieces. The foam is non-toxic.

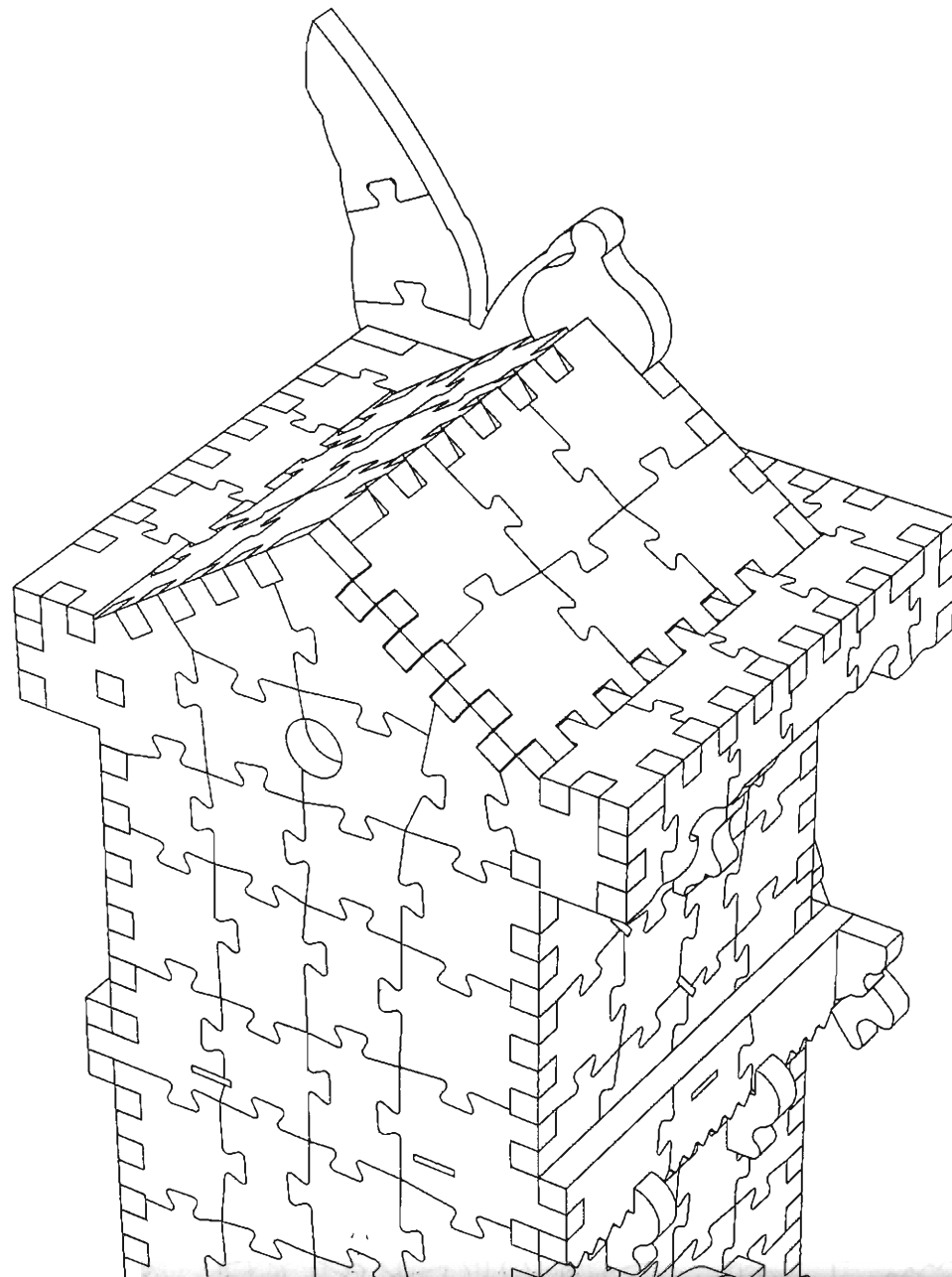
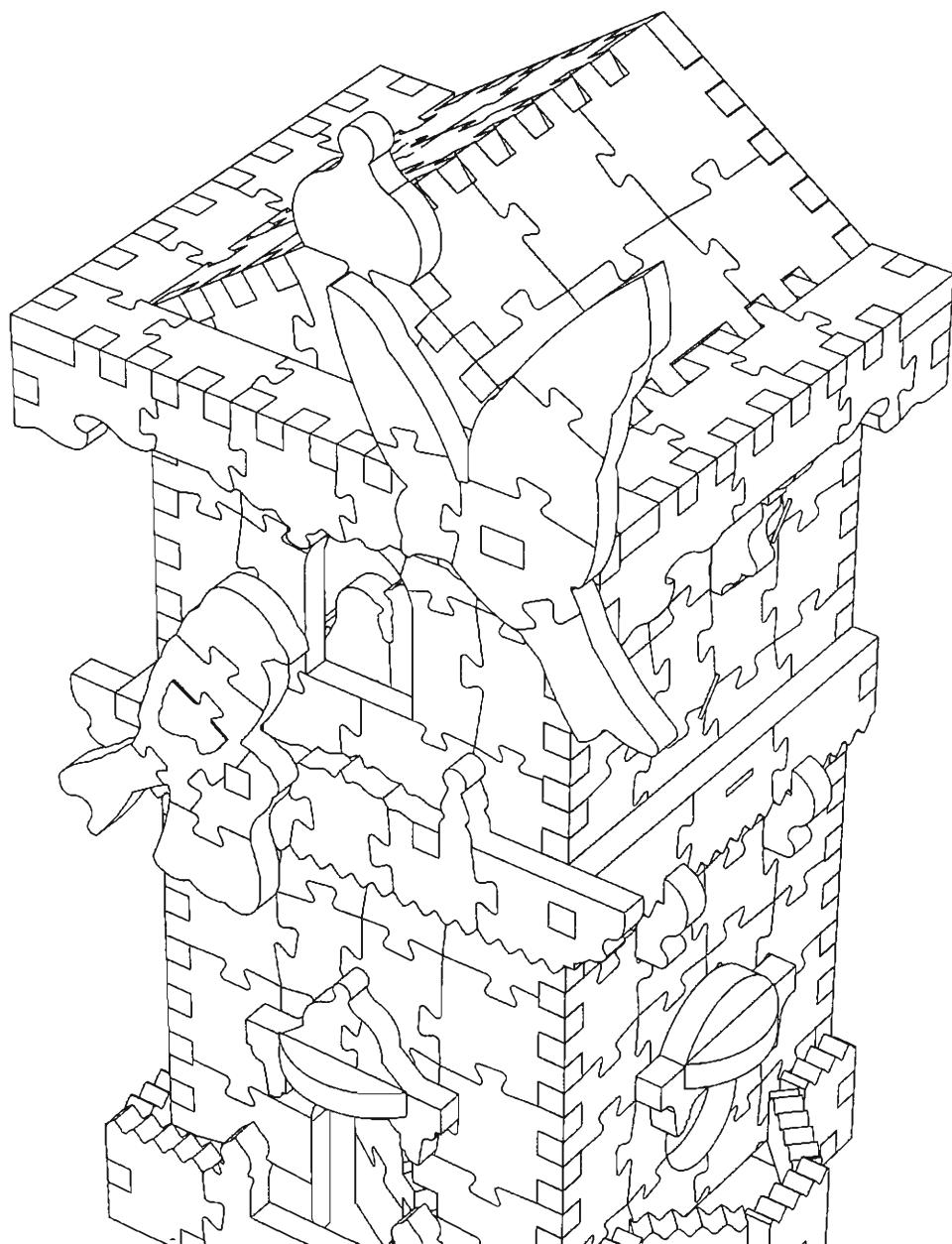

Front

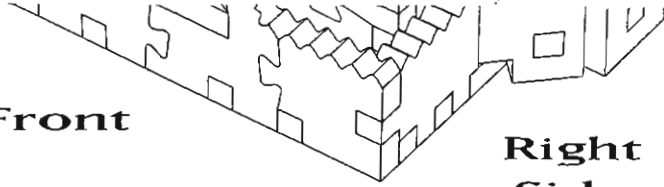

Right Side

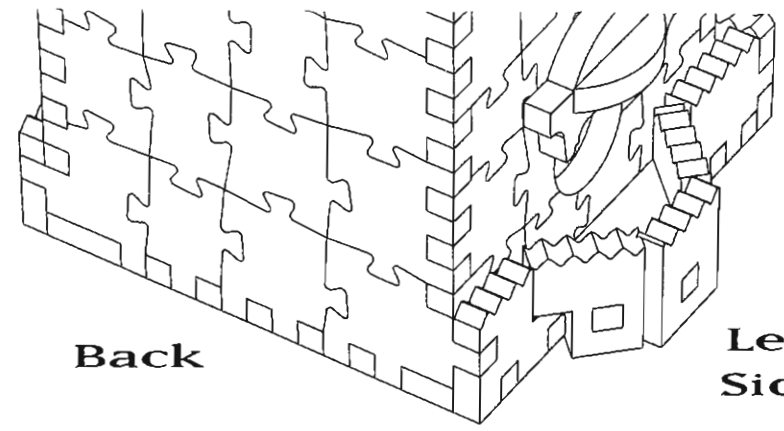

Back

Left Side

Cardboard Support

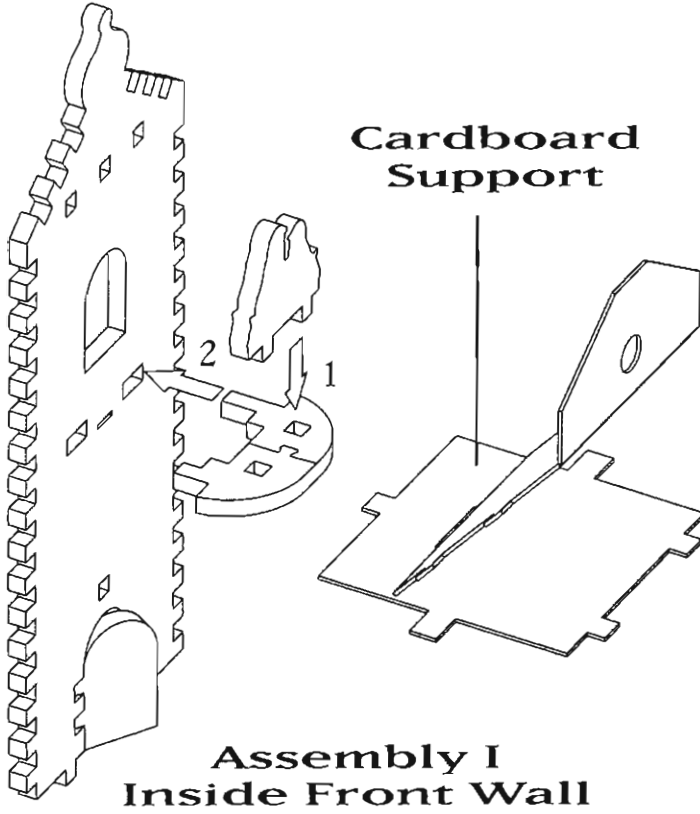

**Assembly 1
Inside Front Wall**

IMPORTANT NOTICE

All pieces with red dots are *not* part of your PUZZ-3D®. Set these pieces aside while you build your puzzle. Then discard them only when your puzzle is complete. Careful! Some unmarked pieces may remain interlocked with red-dot pieces. Also, some waste pieces are too small to be marked with red dots. Therefore, check these pieces thoroughly before discarding.

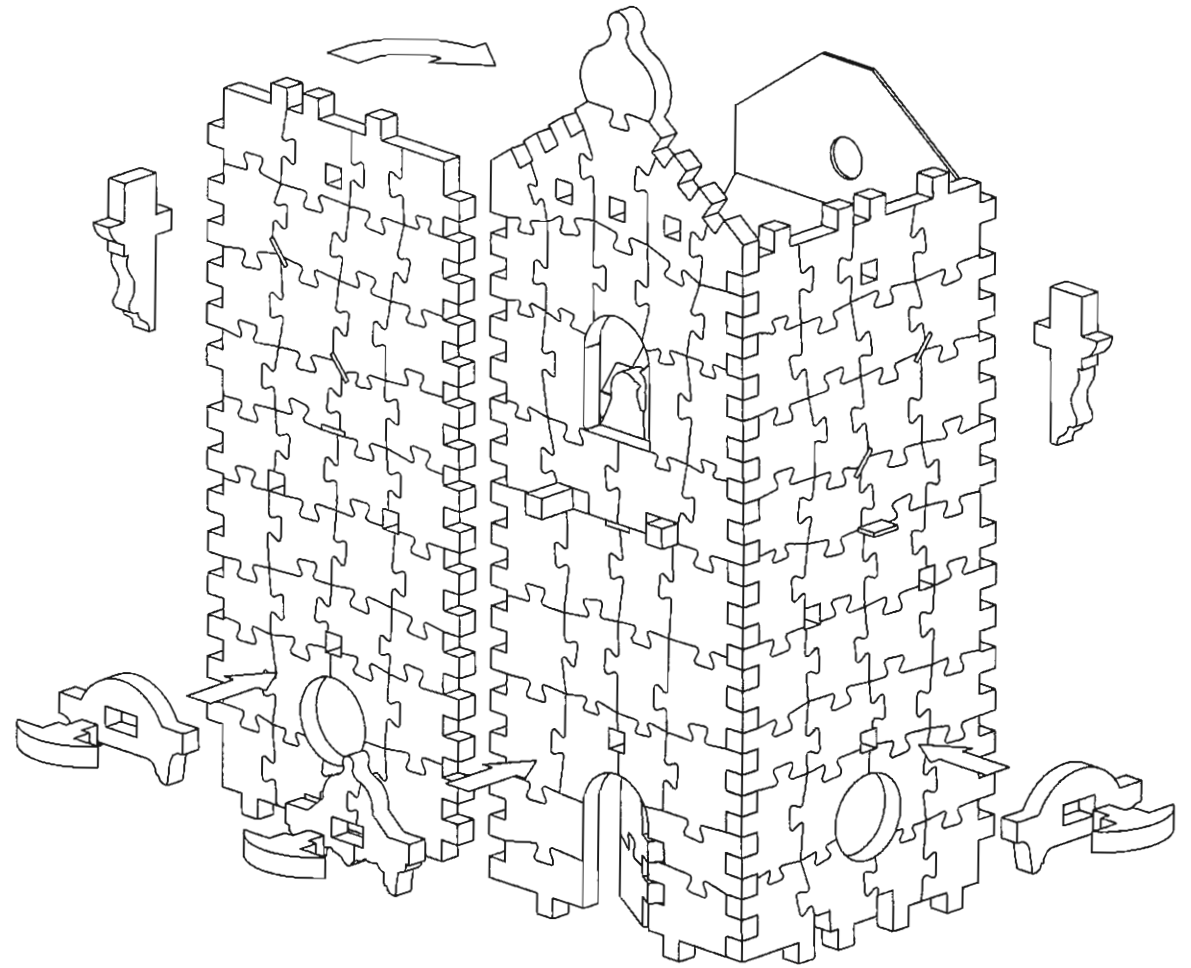

Assembly 2

Missing Puzzle Pieces

If a piece of your PUZZ-3D® is missing or damaged, we will replace it. Simply indicate on this puzzle guide sheet approximately where the problem is occurring. Then send this guide sheet with the area circled, along with your name, address and phone number to the address below.

If your puzzle's missing piece is not clearly shown in any of the drawings, in addition to circling the area, briefly describe which piece you need.

Remember to check thoroughly through your bag of discarded pieces to determine if any puzzle pieces are still attached to red-dot pieces.

Hasbro Games
Consumer Affairs Dept.
P.O. Box 200
Pawtucket, RI 02862
Tel: 888-836-7025 (toll-free).

Within 2 to 4 weeks you will receive the required piece(s).

Name _____
Address _____
City or Town _____
State _____ Zip _____
Phone Number _____

PUZZ-3D® is a trademark owned by 2798140Canada Inc., and the distinctive design elements of the PUZZ-3D® puzzles are used under license from Wrebbit Inc. by Hasbro.
©Wrebbit Inc.
U.S. Patent No. 5,251,900
The Happy Frog logo is a trademark owned by Wrebbit Inc.
www.hasbro.com
The HASBRO name and logo are TM & ©2000 Hasbro, Pawtucket, RI 02862.
All Rights Reserved. 49153-X2

Designed by:
Wrebbit INC./TM

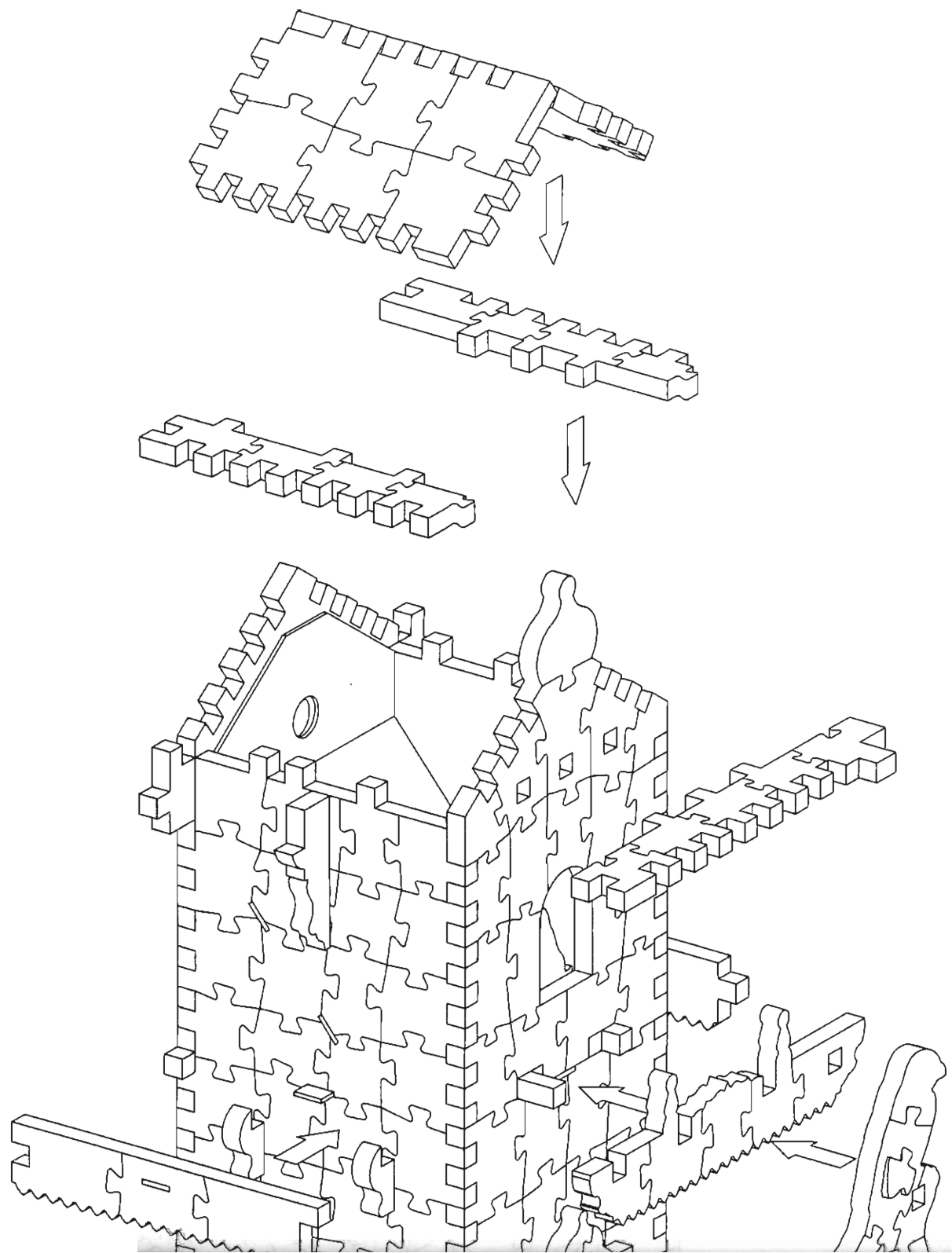

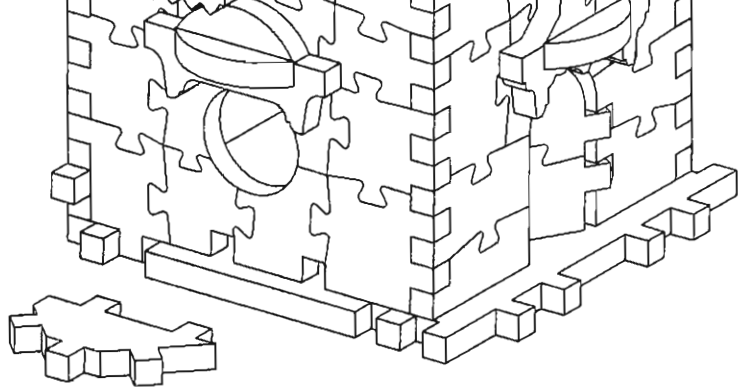

Assembly 3

Important Building Information

Vertical portions of your puzzle (such as walls) fit onto the horizontal portions (floors, rooftops, etc.) as shown in the illustrations below. You may find it easier to build the base of your puzzle first, then attach the puzzle wall pieces to the base.

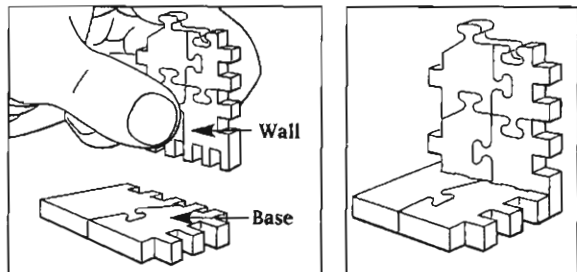

Remember to refer to the different views of the completed puzzle on the back of your box when working on those parts of your puzzle.

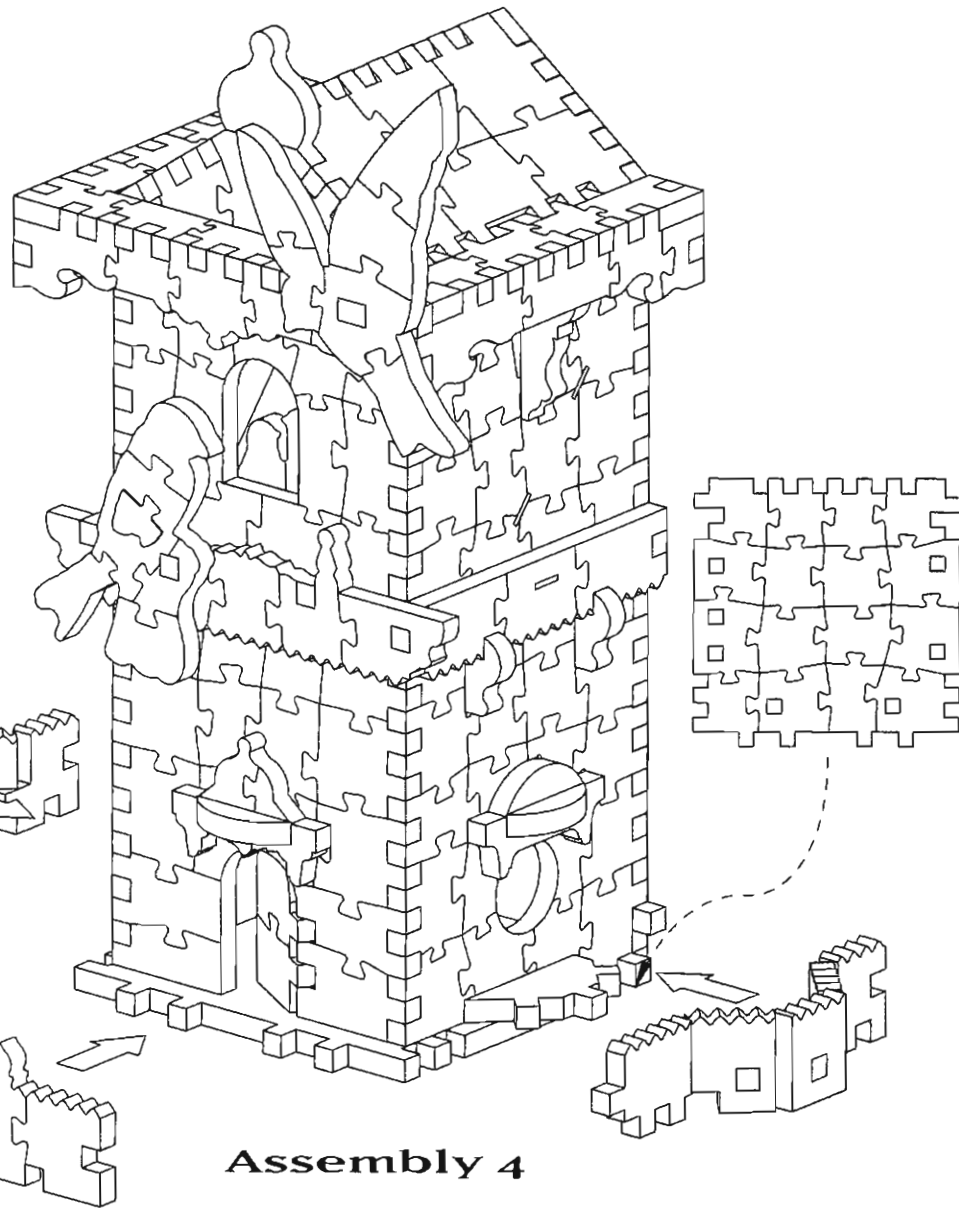

Assembly 4

ASSEMBLY INSTRUCTIONS FOR YOUR PUZZ-3D® ADVENTURE!

1 Remove and set aside waste pieces

Pieces with red dots on them are not to be used in your puzzle. Remove them from your bag of puzzle pieces and set them aside. Some are very tiny - about 1/4 inch square - and you will need to remove them from the inside of puzzle pieces. **DO NOT THROW AWAY ANY RED-DOT PIECES!** Frequently, puzzle pieces are still attached to red-dot pieces and it's easy to miss them. For now, remove all the red-dot pieces and place them in a safe place, such as a zip-top plastic bag.

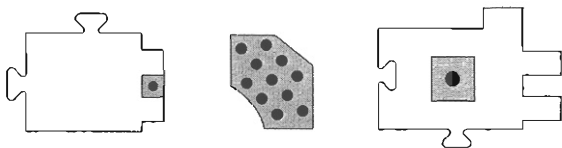

Various types of red-dot pieces

2 Examine the types of puzzle pieces

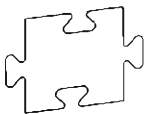

Jigsaw: These pieces have regular jigsaw cuts and are used in the middle of a wall or base. They are never used to create an edge or corner.

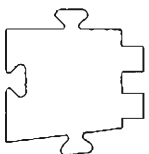

Square: These pieces have square cuts on one or more sides. They "dovetail" with pieces having the same type of edge to form an angle when they connect. These pieces create your puzzle's corners and are what make your Puzz-3D three-dimensional! A corner can be formed by connecting a base to a wall, a roof to a wall or a wall to another wall. See illustration.

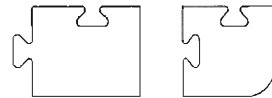
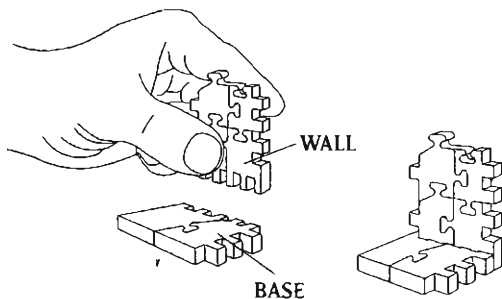

Straight edge Curved edge

Edge: These pieces have one or two straight or curved edges. The outside edge of the base of your puzzle is made up of these, but they can also create an edge of another section, such as the top of a wall.

Decorative: The remainder of your pieces are decorative and are usually added at the end to complete your puzzle. An example would be the top of a tower.

3 Assemble the sections

Sort pieces according to color and design, then assemble them to form flat sections of your puzzle. Since your Puzz-3D is made from foam, it's much easier to mistakenly fit the wrong pieces together than it is with cardboard! When connecting pieces, be sure the artwork on the two pieces matches *perfectly*. Look for subtle color, shade and design differences between pieces. In most cases, a finished section will have its perimeter entirely made up of square cut pieces, as shown here. Some sections, however, may have one or more sides that are straight or curved.

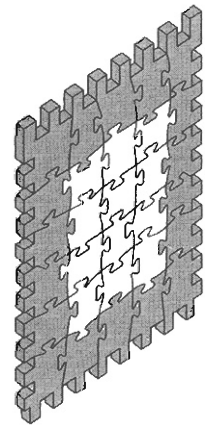

A completed section with square cut pieces in gray

4 Think vertical!

Remember, your puzzle is not just a *picture*, but a dimensional model! **The inside will be hollow.** The vertical walls attach to the horizontal base wherever each side consists of square cut edges. The base will be flat and the walls will go UP!

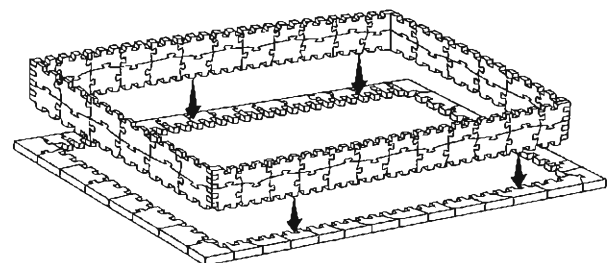

A sample of a base and wall