

### ASSEMBLY AND INSTRUCTIONS

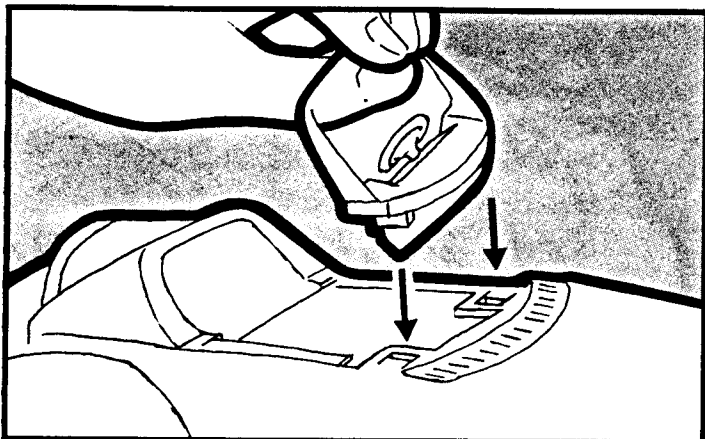

**1** Snap windshield into position.

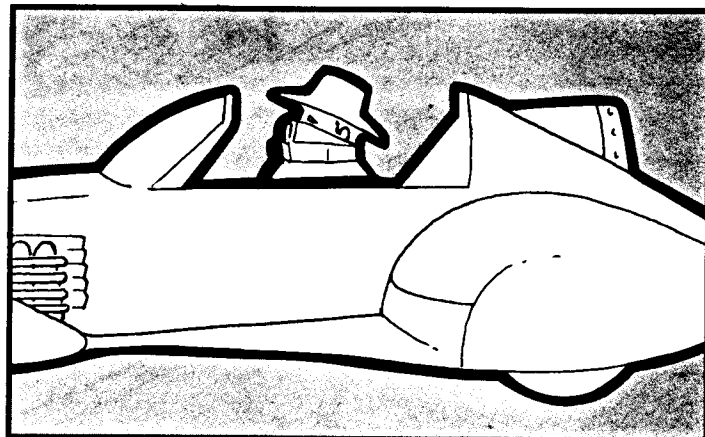

**2** Place figure in vehicle as shown.

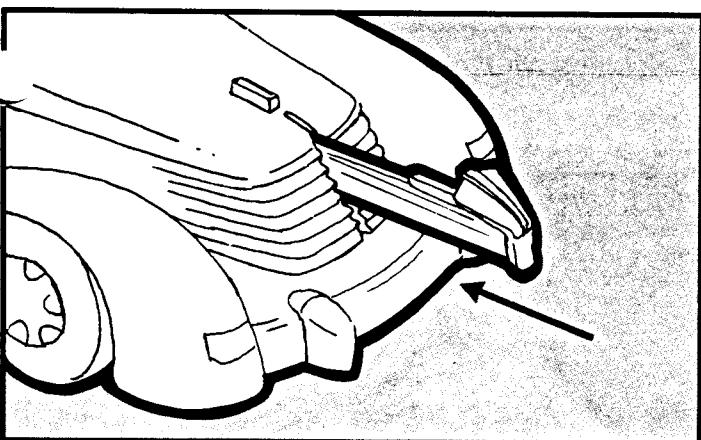

**3** Load hood ornament missile all the way into front of vehicle.

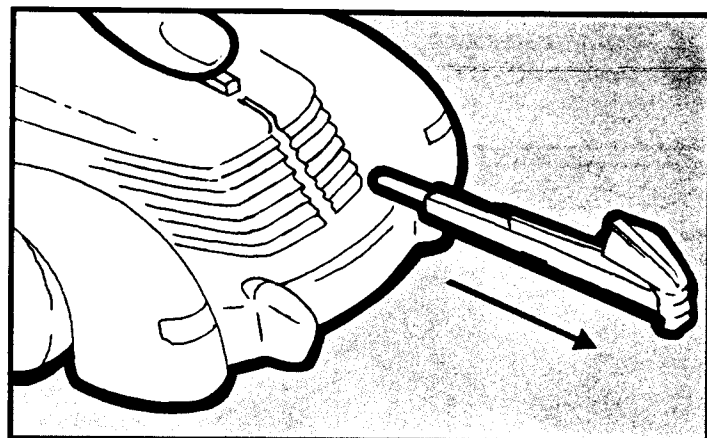

**4** Press firing button to launch hood ornament missile.

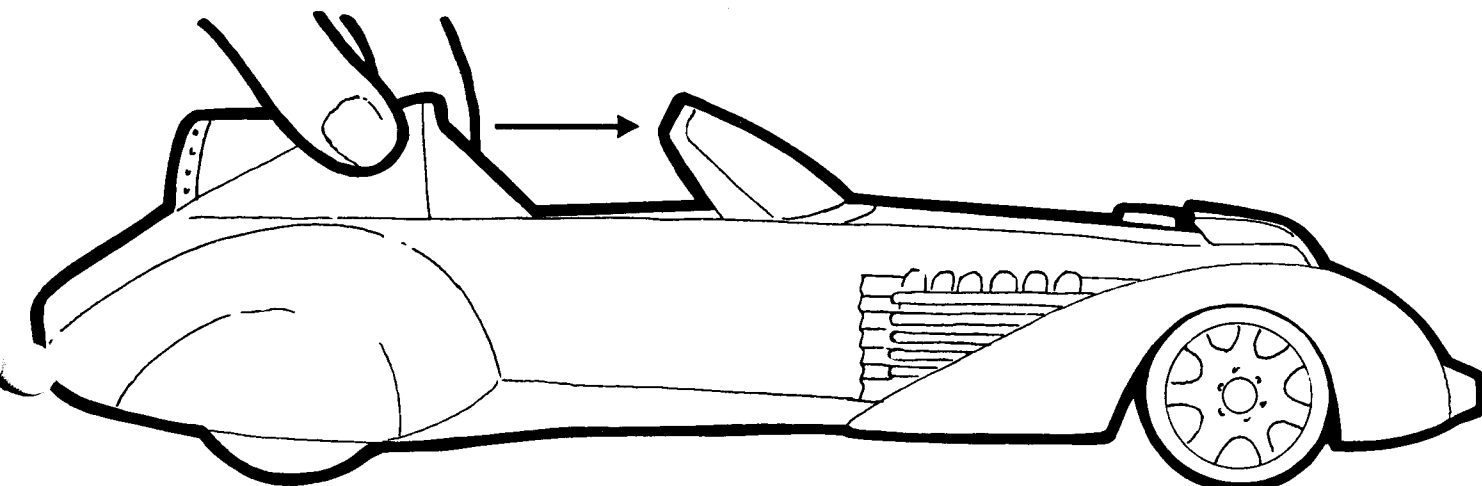

**5** Slide roof forward to hide figure and expose thruster compartment.

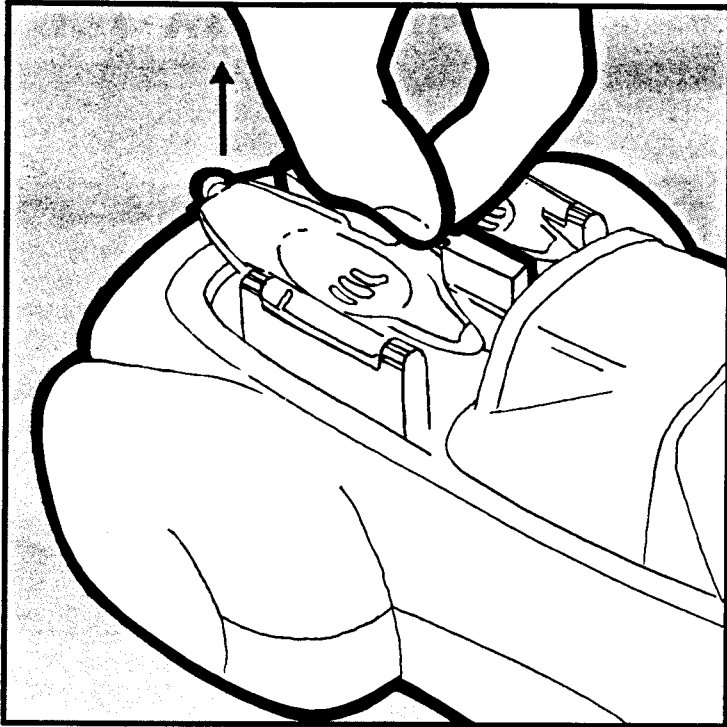

**6** Pull thruster compartment up.

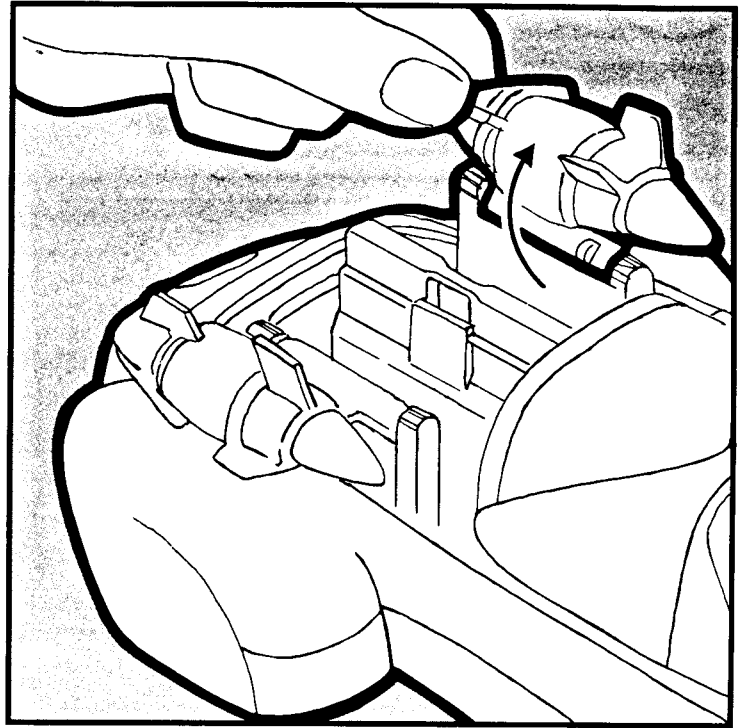

**7** Rotate each thruster outward.

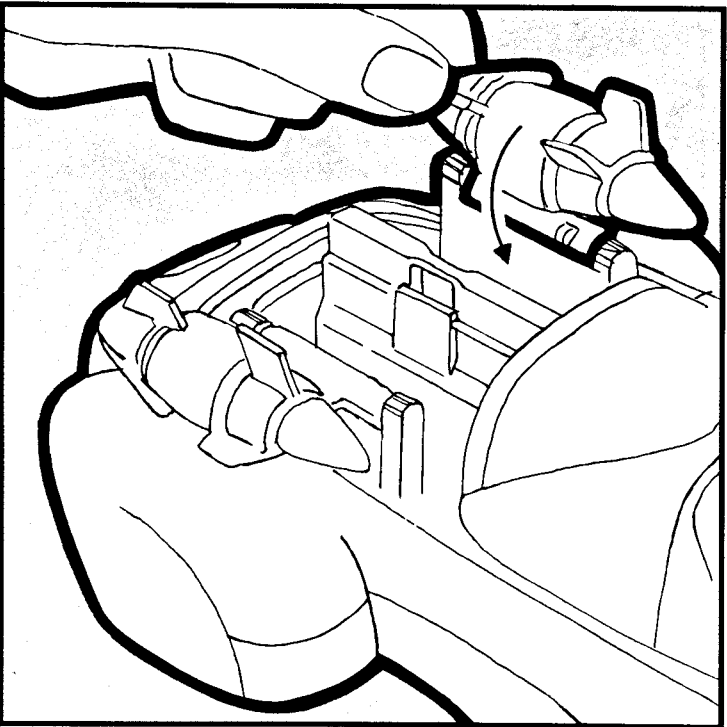

**8** Replace each thruster by rotating back into compartment.

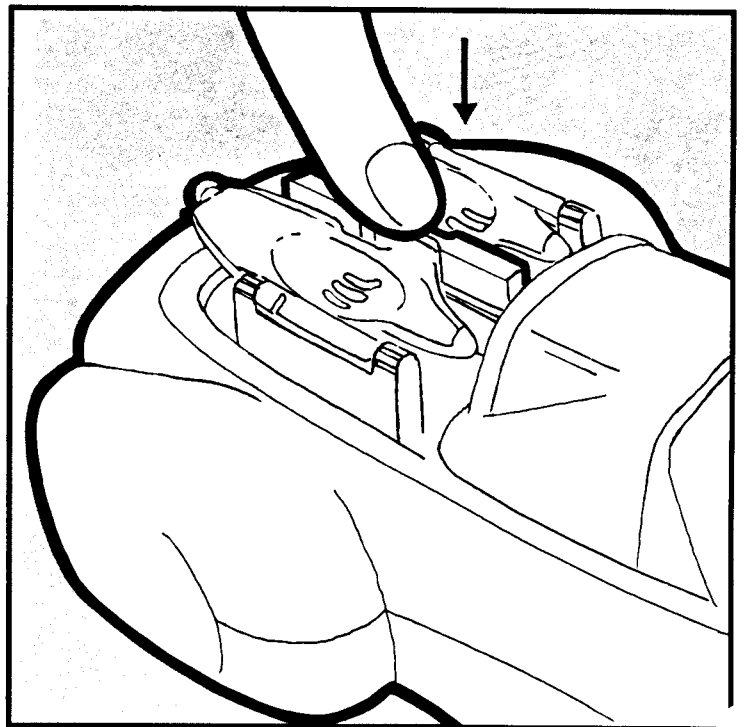

**9** Push thruster compartment down. Slide roof back to cover thruster compartment.

