

Ages 3 & Up

PLAYSKOOL

Tinkertoy[®]

Construction System

Instructions

**WELCOME TO THE EXCITING NEW WORLD
OF TODAY'S TINKERTOY!**

With this complete, easy-to-assemble system, you can build with one set or combine pieces from different sets to create an endless variety of colorful, free-moving structures! Below are some examples to help you get started.

Happy Tinkering!

To identify the pieces you'll be using, refer to the key at right.

2 Blue Spinning Spools
and connects 2 Red Wheels



Orange Washer



Yellow Connector Spool

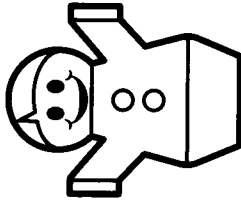

Yellow Figure

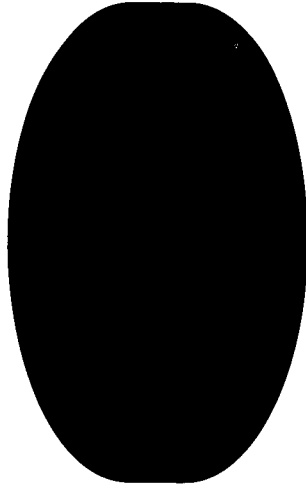

Red Lid - use it as a base for
some of your creations!



Orange End Cap

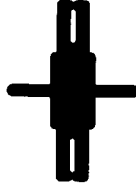

Purple Connector



Green Bearing



Green Rod



Red Rod



Blue Rod



Purple Rod



Orange Rod



Red Triangle



Red Square

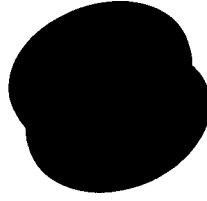

Blue Spinning Spool

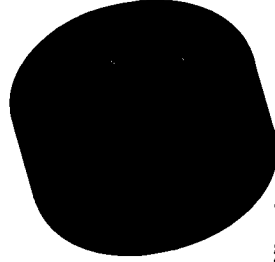

Red Wheel

Create these designs with the 801 BIG BUILDER™ set or larger sets:

Swing Set

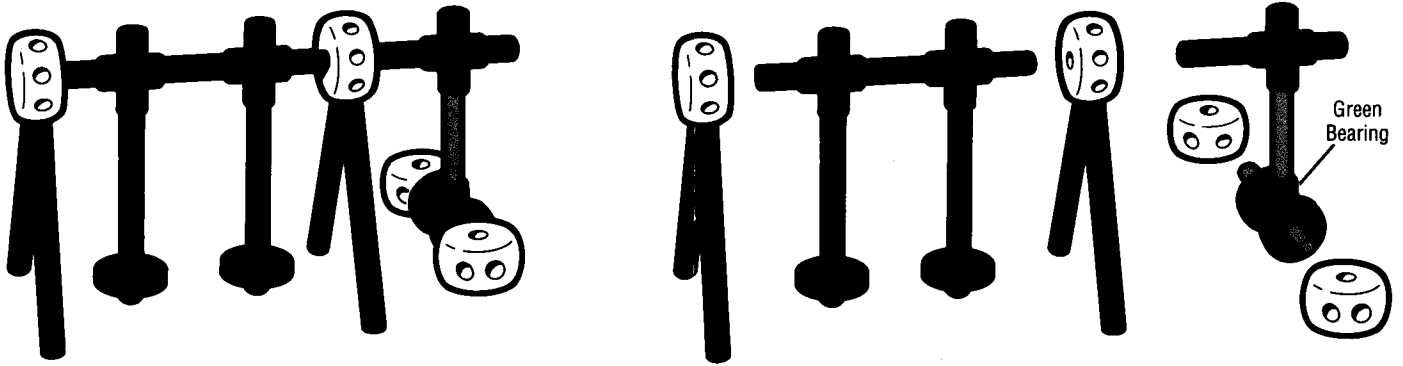

Mini Ferris Wheel

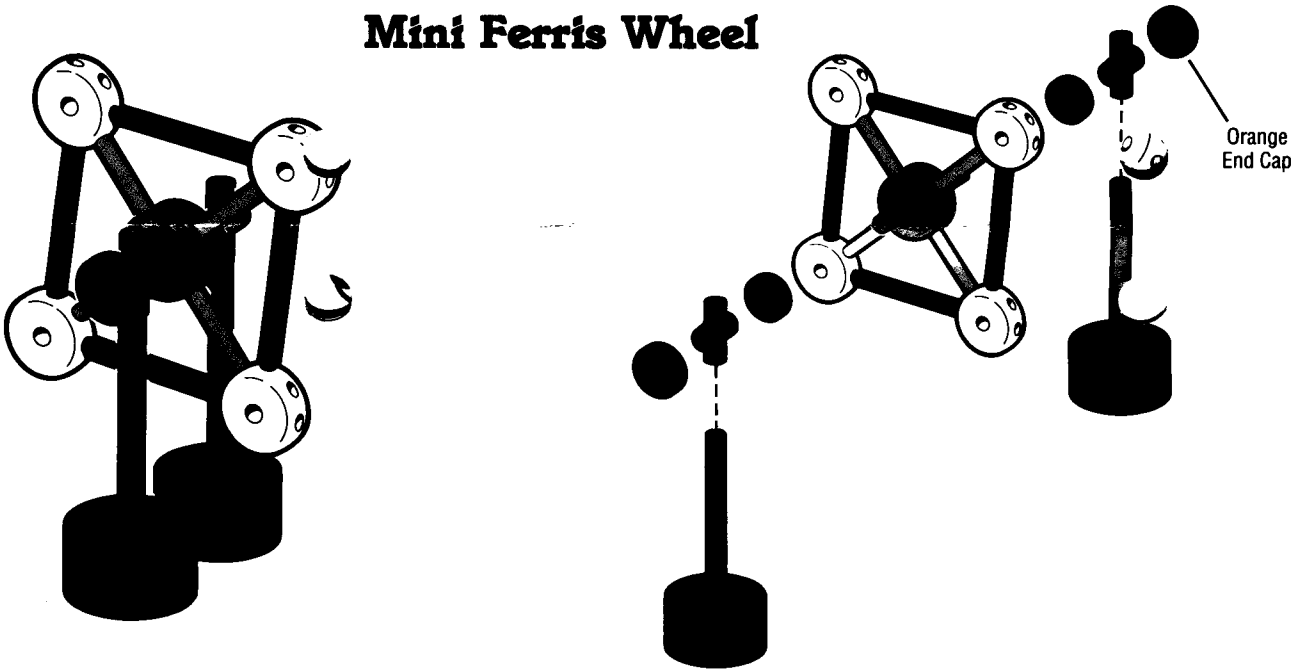

Off-road Cycle

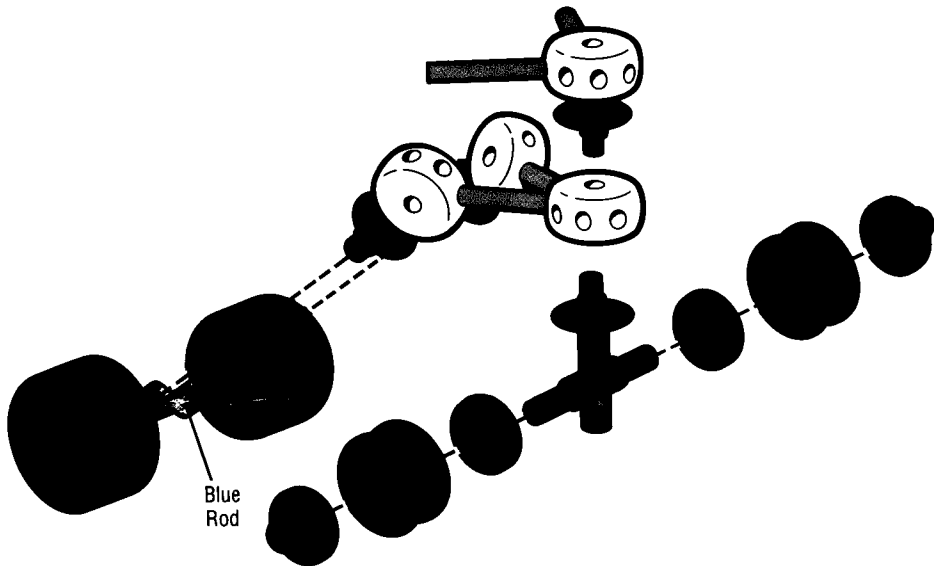
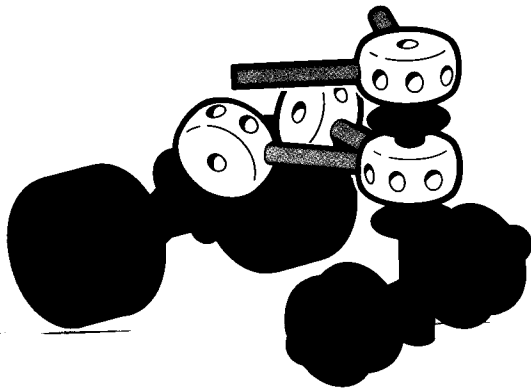

Sailboat

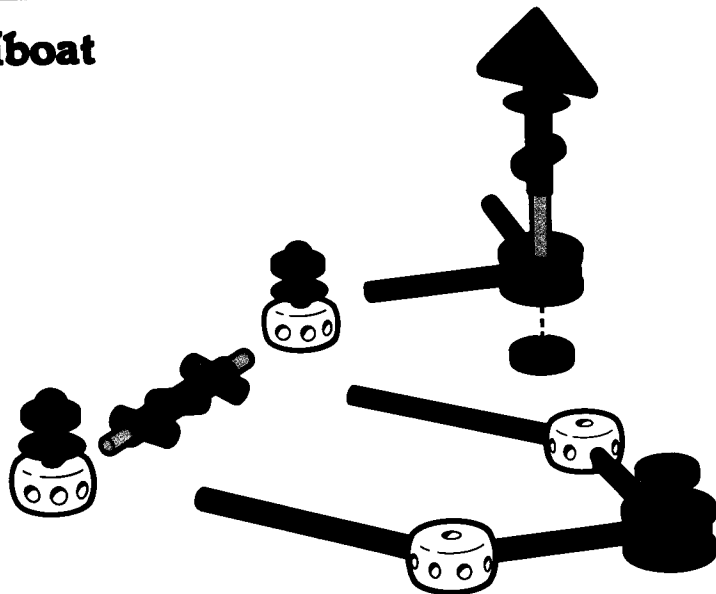
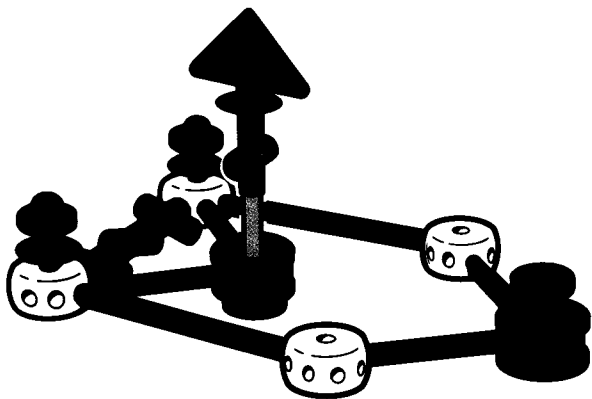

Build structures like these with the 802 DYNAMIC DESIGNS™ set or larger sets:

Jumbo Jet

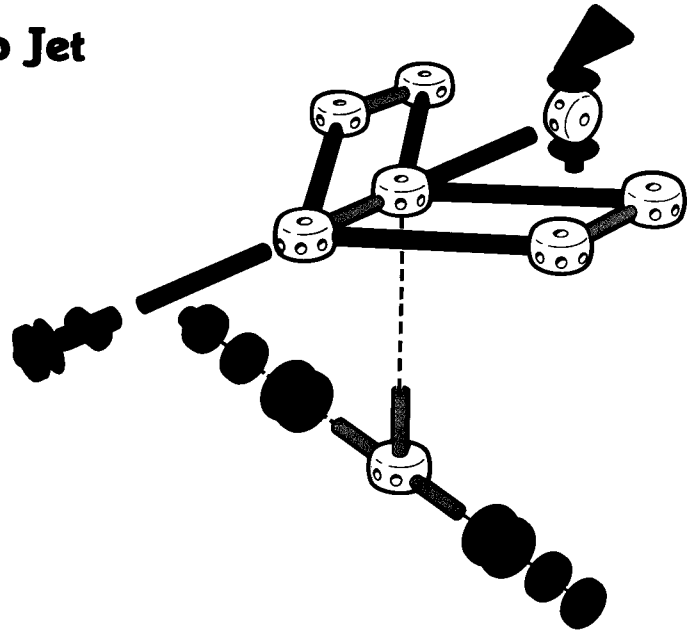
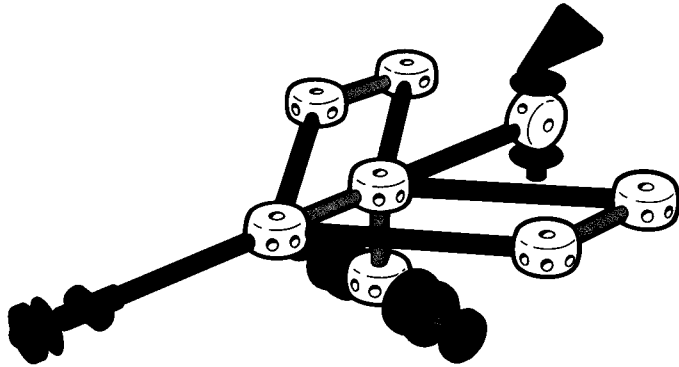

Airplane

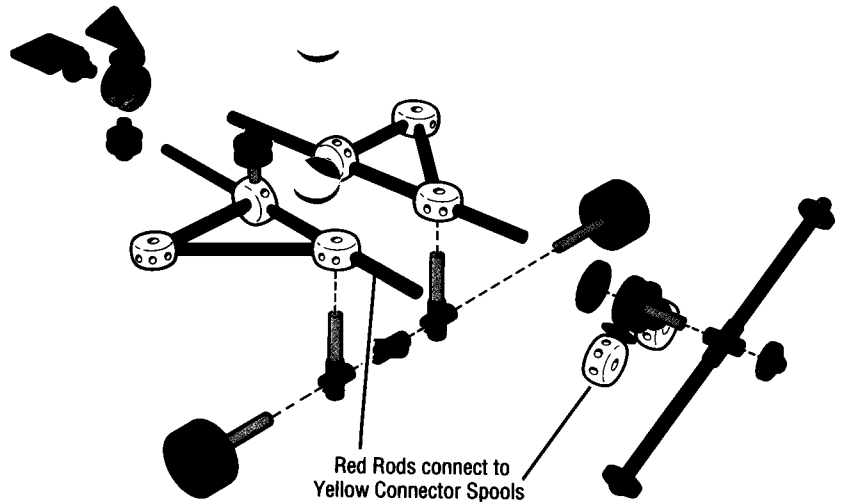
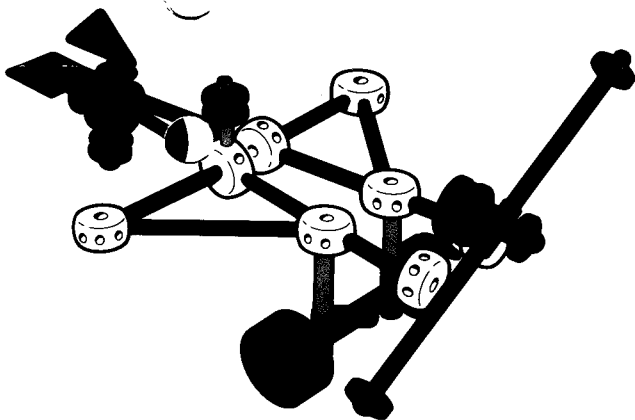

Assemble these forms with the 803 KING-SIZE CREATIONS™ set or 804 COLOSSAL CONSTRUCTIONS™ set:

Ostrich

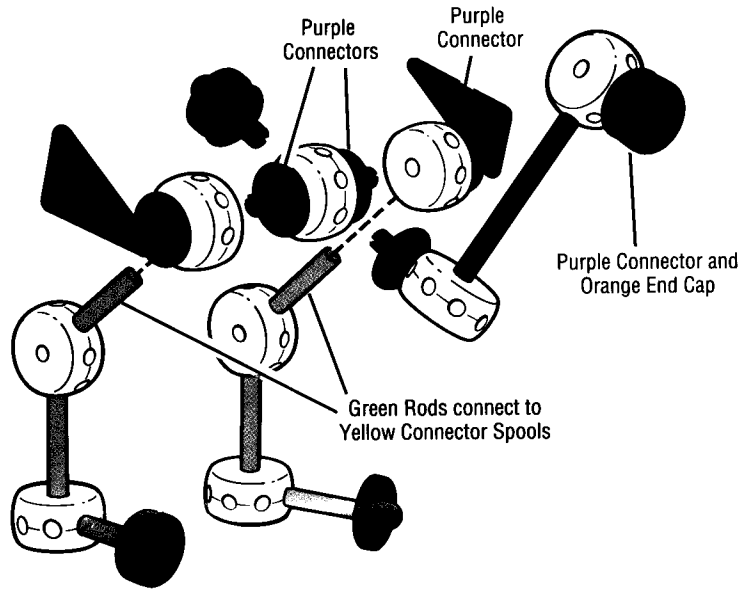
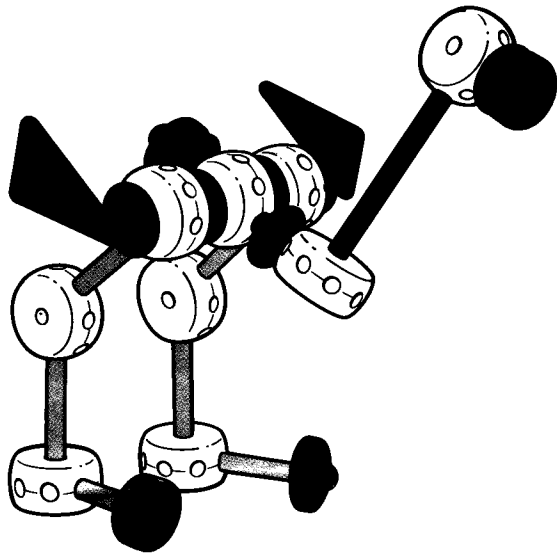

Dragster

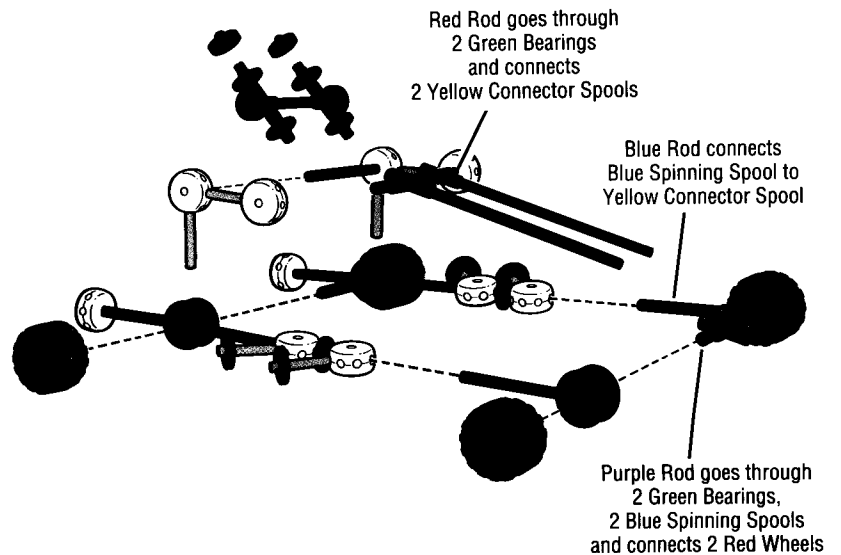
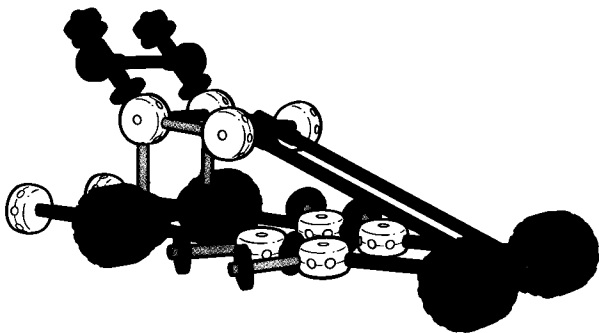

Windmill

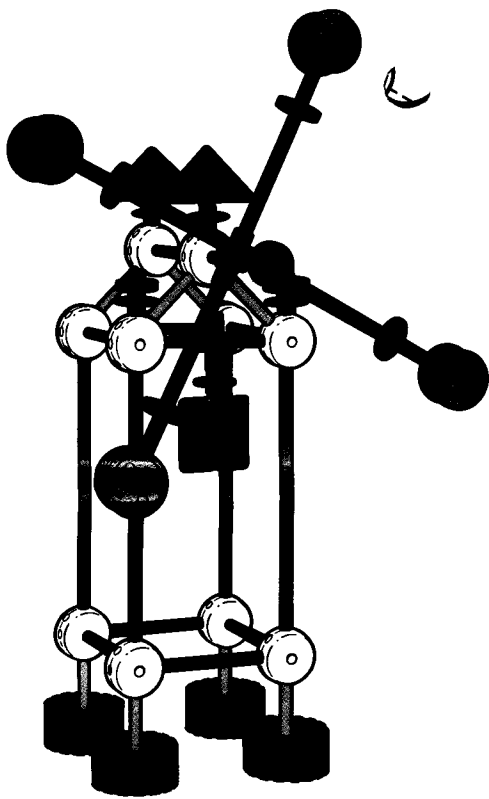

Red Rod goes through
2 Green Bearings
and into
Orange End Cap

Blue
Rod

Purple Connector and
Orange End Cap

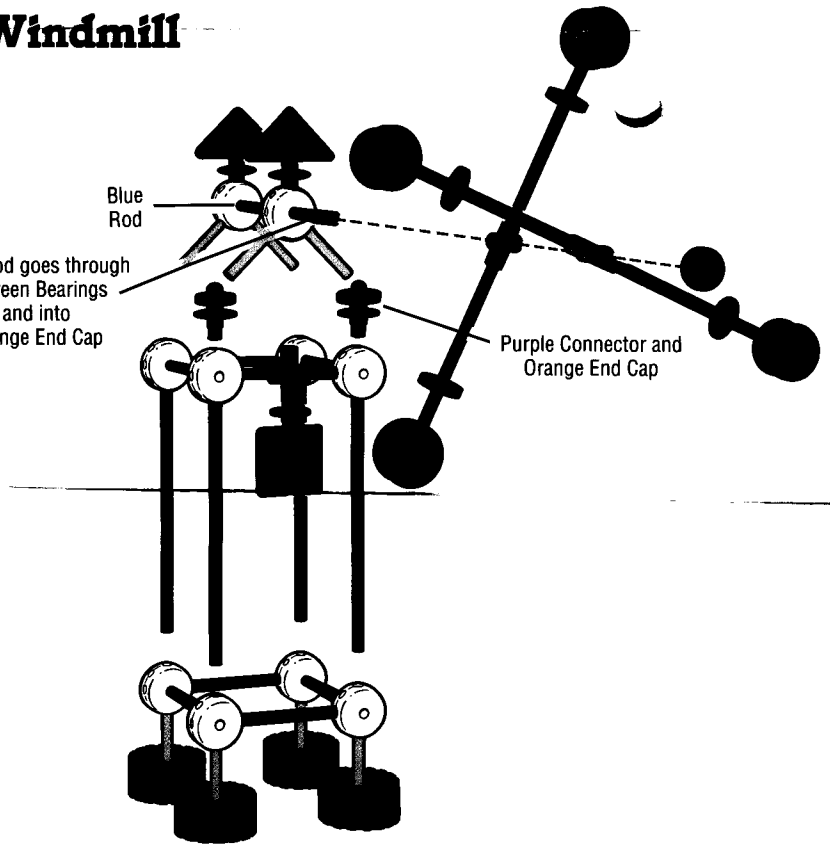

Crane

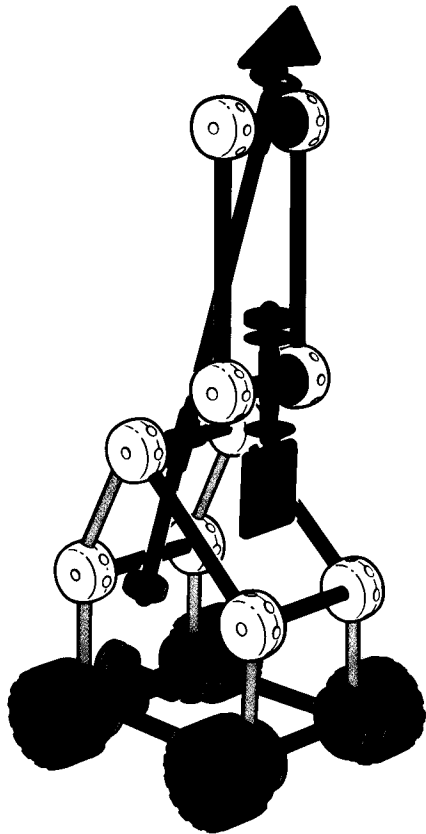

Green Rod goes through
Green Bearing and Orange
Washers to connect
Yellow Connector Spools

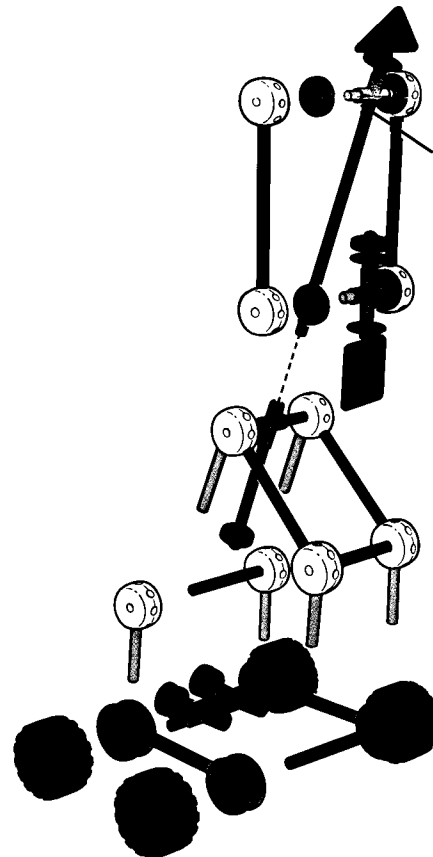

With the 804 COLOSSAL CONSTRUCTIONS™ set, you can create:

Merry-Go-Round

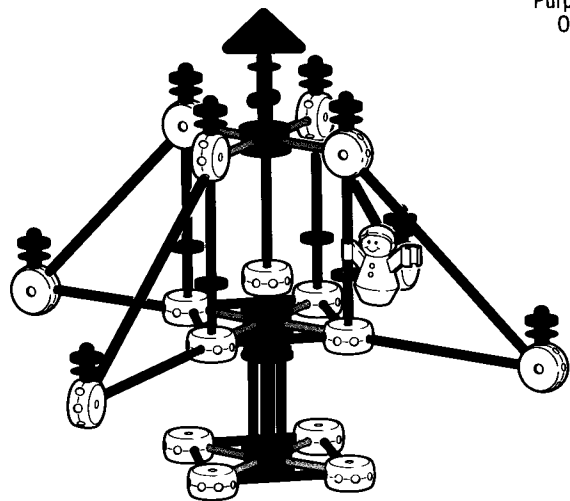

Purple Connector and
Orange End Cap

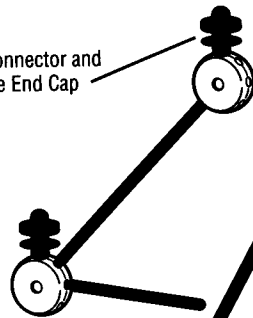

Purple Connector and
Orange End Cap

Purple
Connector

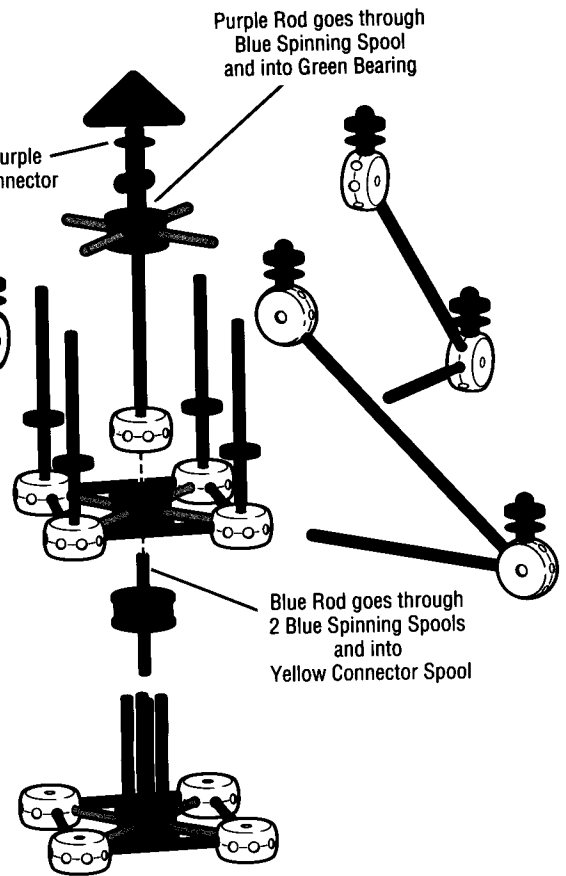

Purple Rod goes through
Blue Spinning Spool
and into Green Bearing

Blue Rod goes through
2 Blue Spinning Spools
and into
Yellow Connector Spool

Helicopter

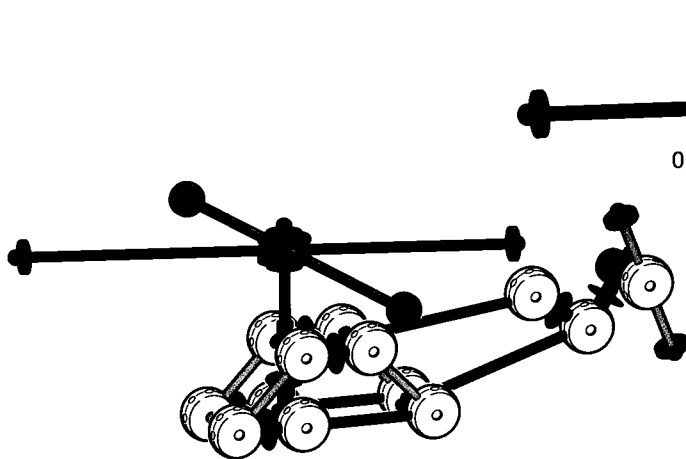

Orange Washer goes
underneath Blue
Spinning Spool

Green
Rod

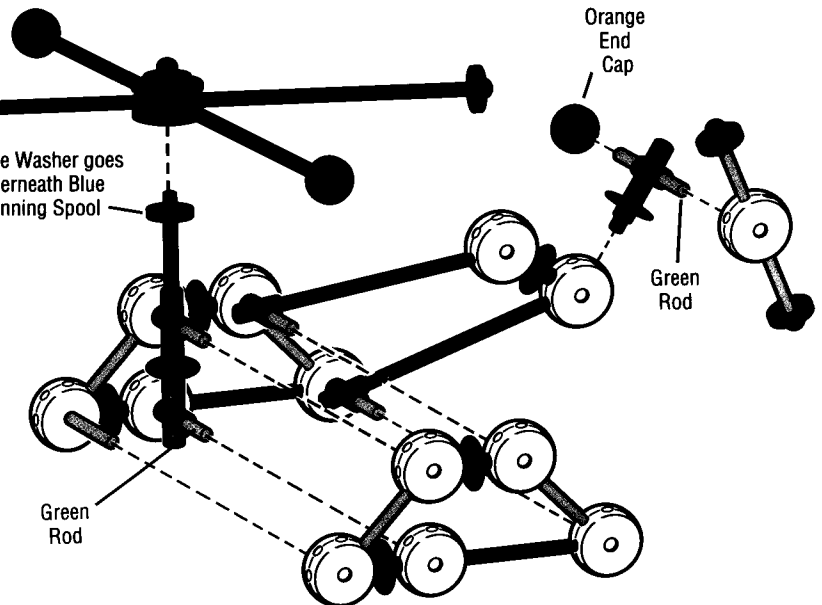

Orange
End
Cap

Green
Rod

Giant Ferris Wheel

2 Gir
2 Gir

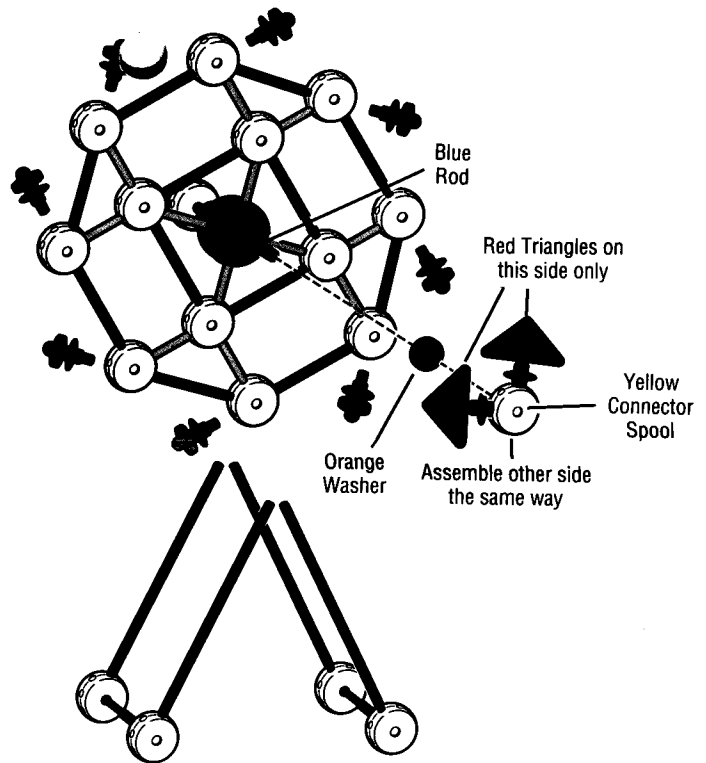
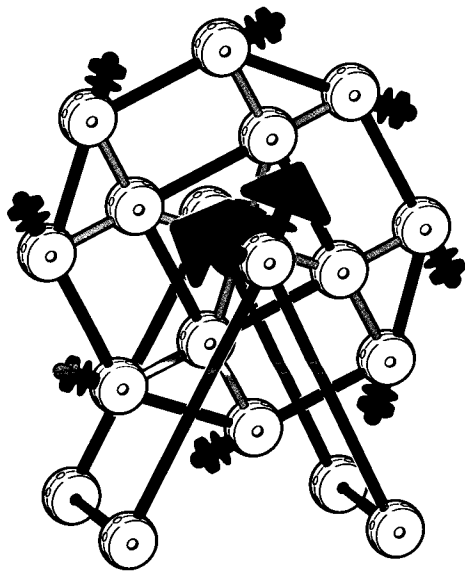

Amusement Ride

