

# TRANSFORMERS ARMADA

**BONECRUSHER® • KNOCK OUT™ • WRECKAGE®**

## INSTRUCTIONS INSTRUCCIONES

**NOTE:** Some parts are made to detach if excessive force is applied and are designed to be re-attached if separation occurs. Adult supervision may be necessary for younger children.

**NOTA:** Certaines pièces se détacheront sous une trop forte pression; dans un tel cas, il suffit de les réassembler. La supervision d'un adulte peut être nécessaire pour les plus jeunes enfants.

**NOTA:** Algunas piezas podrían desprenderse si se aplica demasiada presión. Si ello ocurre, vuelve a unirlos. Requiere la supervisión de un adulto con niños más pequeños.

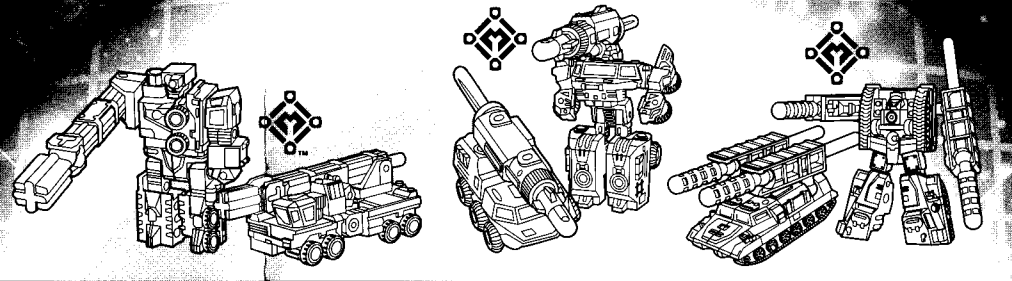

transformers.com

P/N 615851000

## CHANGING TO ROBOT • POUR CHANGER EN ROBOT • PARA CAMBIAR EN ROBOT

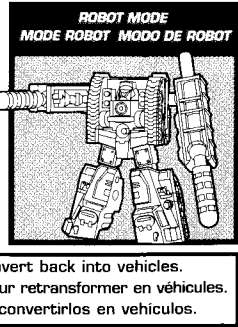
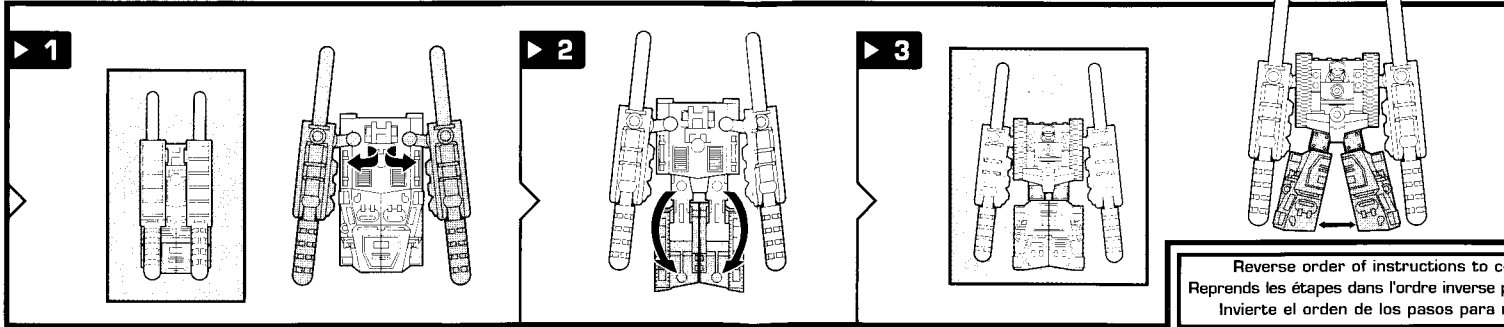
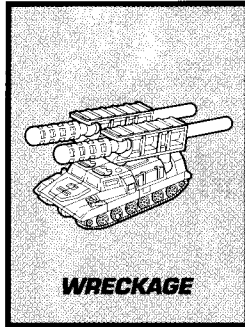
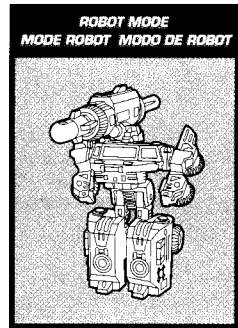
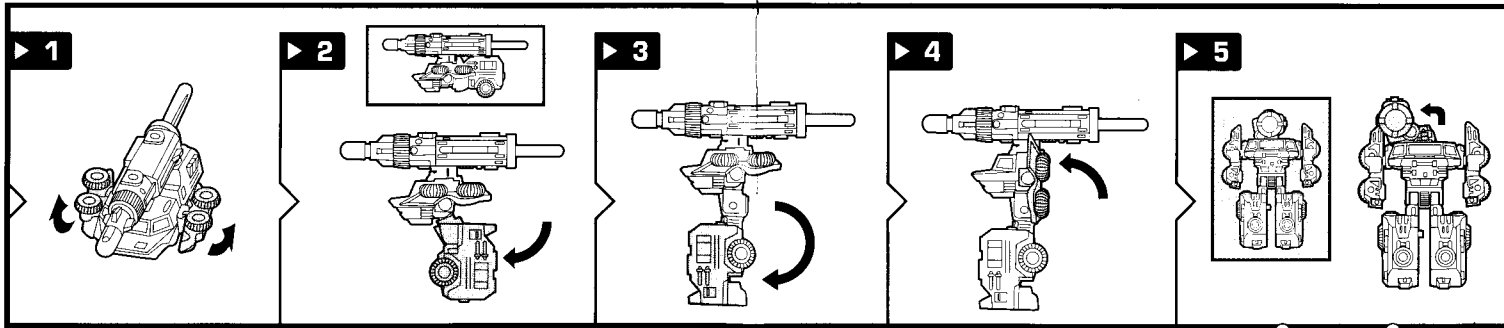
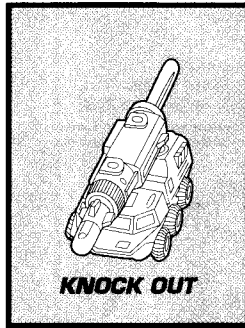
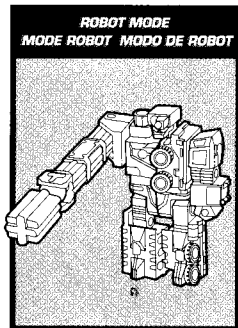
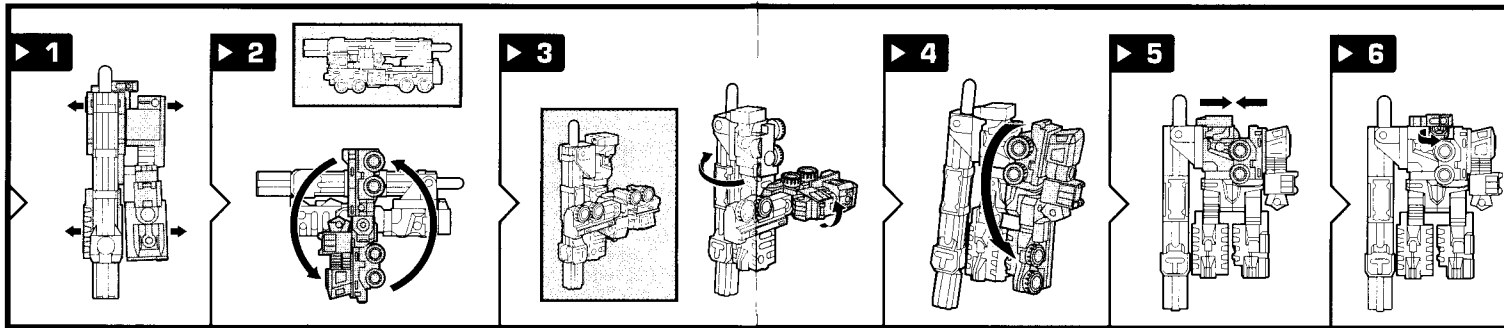
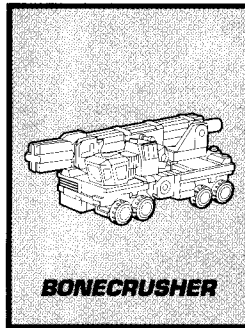

Reverse order of instructions to convert back into vehicles.  
Reprends les étapes dans l'ordre inverse pour retransformer en véhicules.  
Invierte el orden de los pasos para reconvertirlos en vehículos.



The AUTOBOT® and DECEPTICON® robots battle for control on their home planet Cybertron. A signal reaches them from another world, revealing the existence of the MINI-CON™ robots. This lost race of TRANSFORMERS® robots has awakened after centuries of hibernation on the planet Earth. The AUTOBOTS™ and DECEPTICONS™ follow the signal to Earth, each one hoping to be the first to find the legendary MINI-CON robots – whoever partners with them gains powerful new abilities! The fate of the Earth and the universe depends on who controls these small machines! Will it be the heroic AUTOBOTS or the evil DECEPTICONS?



Les AUTOBOTS et les DÉCEPTICONS s'affrontent dans une lutte pour le contrôle de Cybertron, leur planète mère. Un signal leur parvenant d'un monde lointain leur révèle la présence de robots MINIMODUS, une race oubliée de TRANSFORMERS qui vient de s'éveiller après des siècles d'hibernation sur Terre. Les AUTOBOTS et les DÉCEPTICONS suivent ce signal jusqu'à la Terre, chacun espérant atteindre les légendaires MINIMODUS en premier, car quiconque s'allie à eux verra sa puissance croître! Le sort de la Terre et de l'univers dépend de qui, des héroïques AUTOBOTS ou des maléfiques DÉCEPTICONS, contrôlera ces petites machines!



Los AUTOBOTS y los DECEPTICONS se enfrentan en una lucha por controlar Cybertrón, su planeta de origen. Captaron una señal de otro mundo, revelándoles la existencia de los robots MINIMODUS, una raza olvidada de TRANSFORMERS que se despertó después de siglos de hibernación en el planeta Tierra. Los AUTOBOTS y los DECEPTICONS llegan a la Tierra, cada cual con la esperanza de descubrir primero a los legendarios MINIMODUS, ya que una alianza con estos últimos significaría nuevas y poderosas habilidades. El destino de la Tierra y del universo entero depende de quién controlará estas pequeñas máquinas: ¿Serán los heroicos AUTOBOTS o los malvados DECEPTICONS?

## ATTACK MODE • MODE ATTAQUE • MODO DE ATAQUE

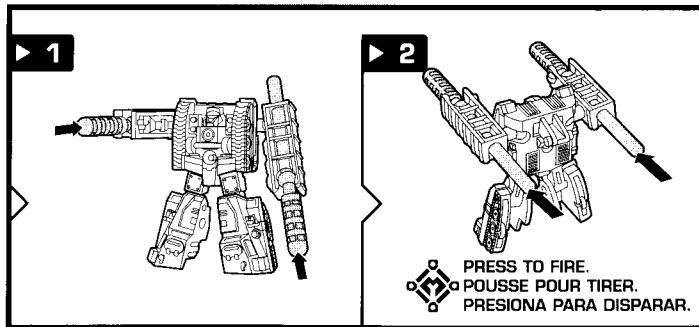
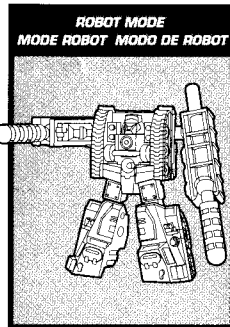
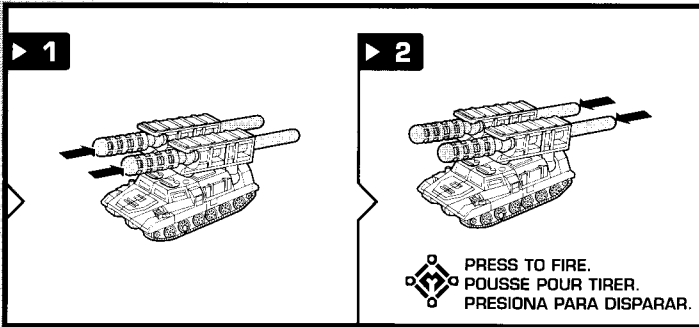
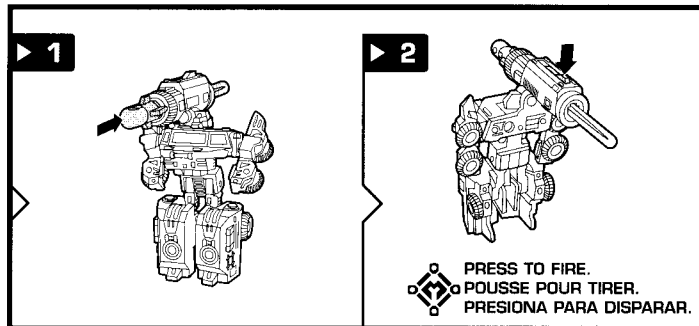
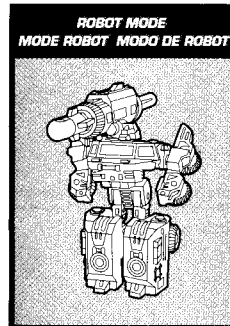
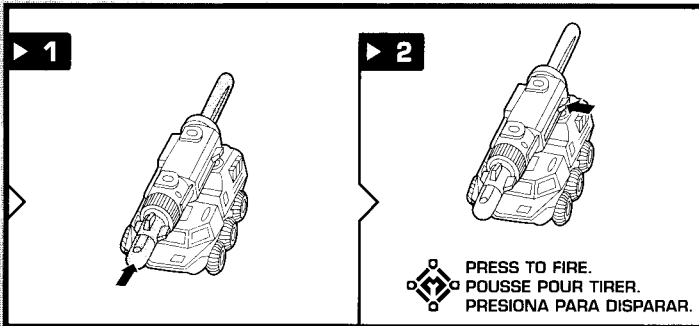
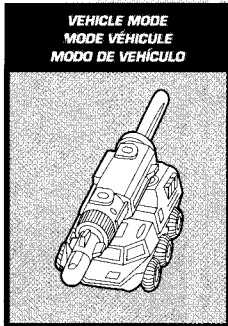
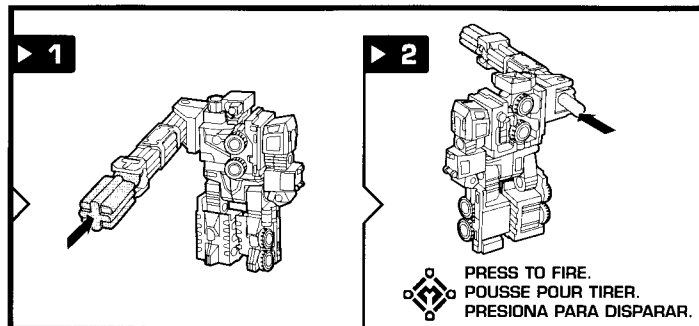
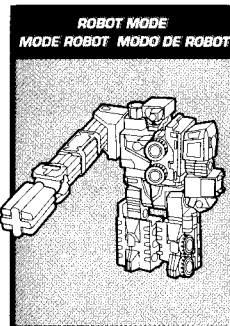
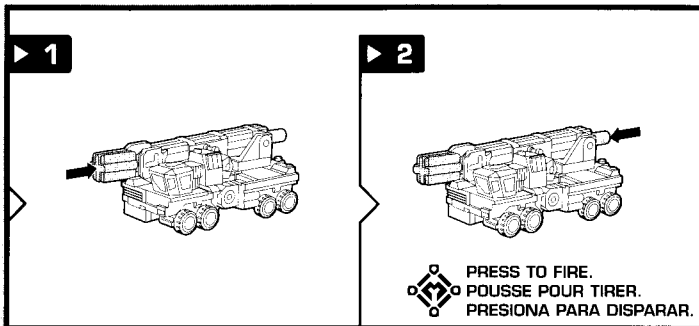
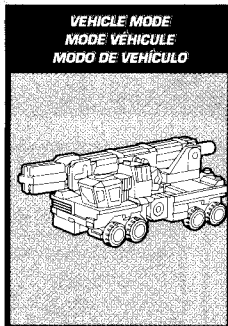

transformers.com



© 2002 Hasbro. All Rights Reserved. ® denotes Reg. U.S. Pat. & TM Office. Manufactured under license from Takara Co., Ltd.

Hasbro Canada, P.O. Box / C.P. 267, Station / Succ. A, Longueuil, QC, Canada J4H 3X6.

Imp.: Servicios Mexicanos de Manufactura S. de R.L. de C.V. km 17,5 Carr. Tlalneantla-Cuatitlán, Loma Bonita, Cuatitlán Izcalli, Edo. de Méx. C.P. 54756 R.F.C.: SMM-990712-156.

Centro de Servicio para México: Tel.: 5872-9483 y para el interior de la República 01-800-712-6225.

### MINI-CON POWERLIX™ FUSION MINIMODUS • UNE LOS MINIMODUS

Each MINI-CON™ figure can attach to a larger TRANSFORMERS ARMADA™ figure (not included)!

Chaque MINIMODUS se relie à une figurine de plus grande taille (non comprise) de l'ARMADA des TRANSFORMERS!

¡Cada MINIMODUS se une a una figura más grande (no incluida) de la ARMADA de los TRANSFORMERS!

