

TRANSFORMERS

CYBERTRON

ROBOTS IN DISGUISE

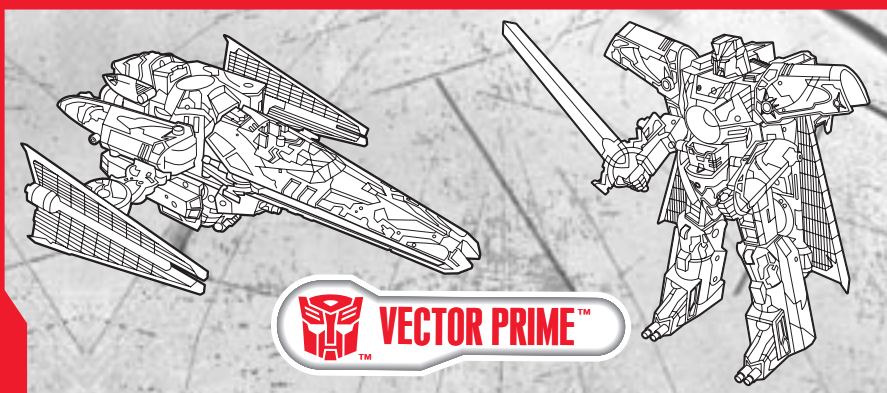

AGES 5+

80913/80287 Asst.

TRANSFORMERS.COM

NOTE: Some parts are made to detach if excessive force is applied and are designed to be re-attached if separation occurs. Adult supervision may be necessary for younger children.

VECTOR PRIME™

Requires 2 x 1.5V "AAA" or R03 size batteries (not included). Alkaline batteries recommended. Phillips/cross head screwdriver (not included) needed to insert batteries.

CHANGING TO ROBOT

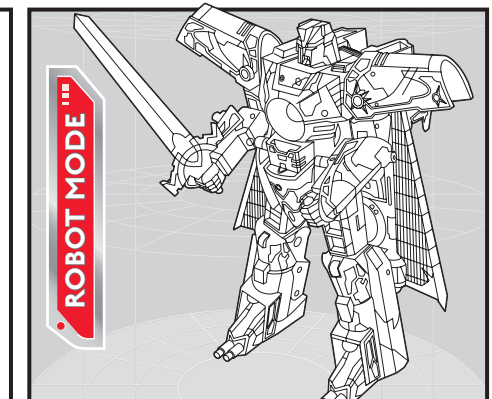
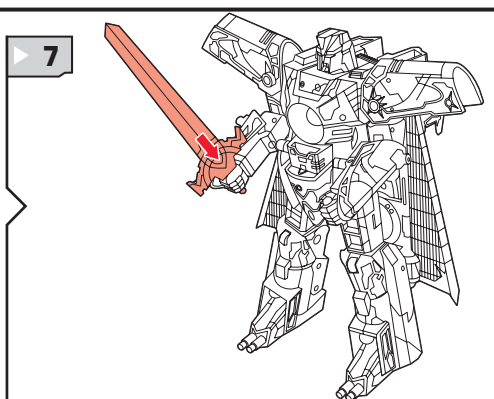
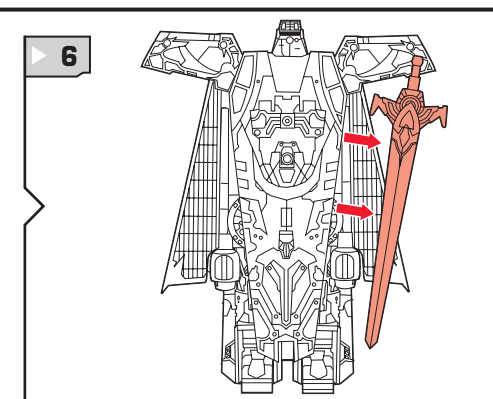
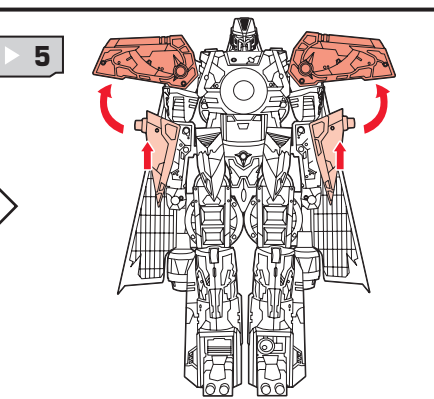
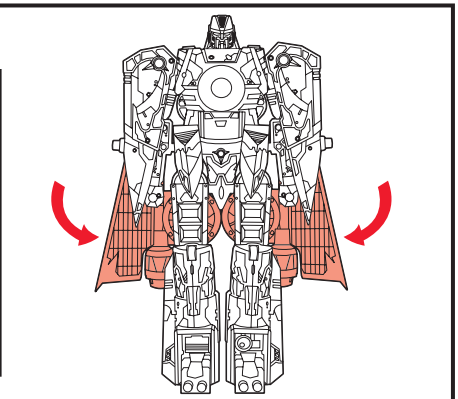
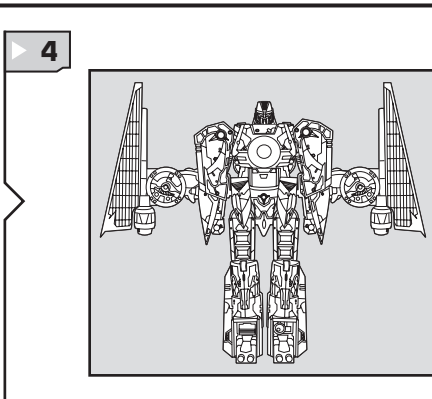
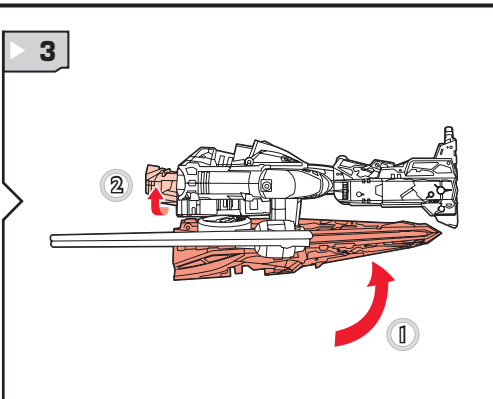
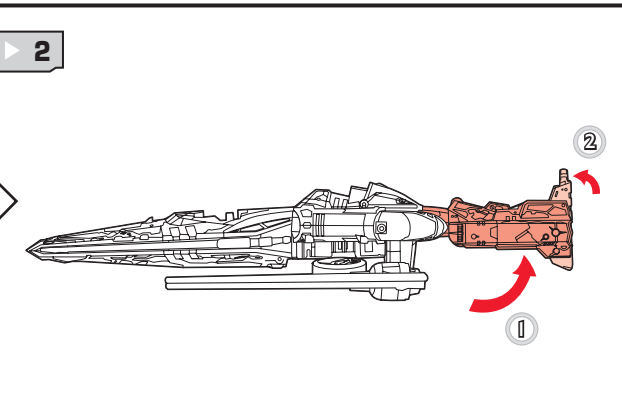
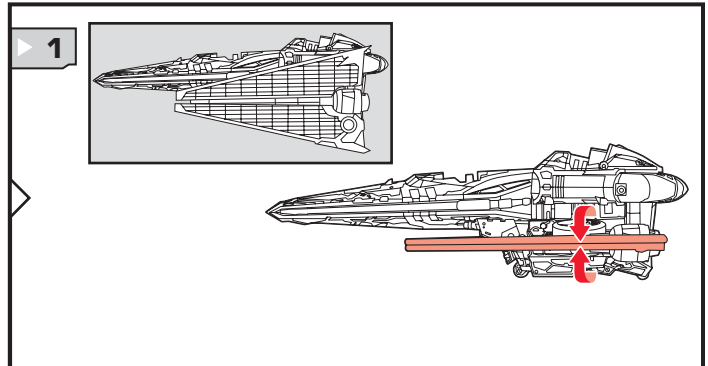
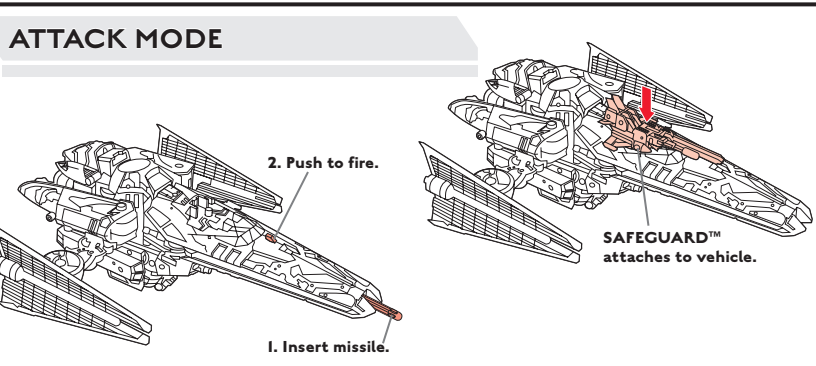
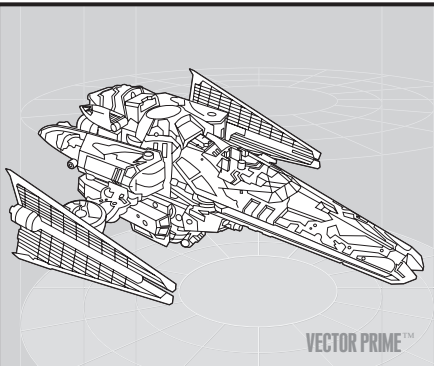

Reverse order of instructions to convert back into vehicle.

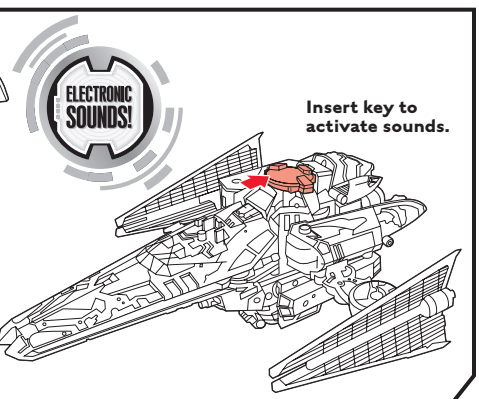
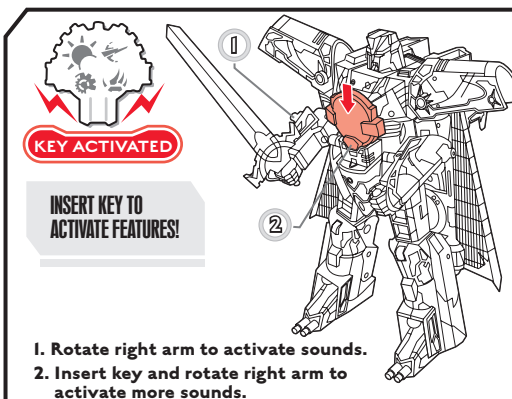
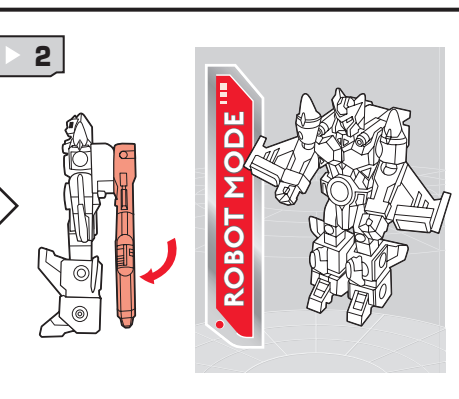
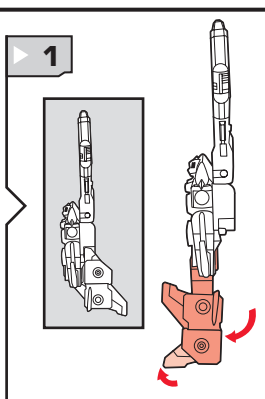
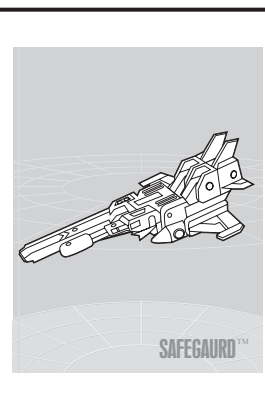

TO INSERT BATTERIES:

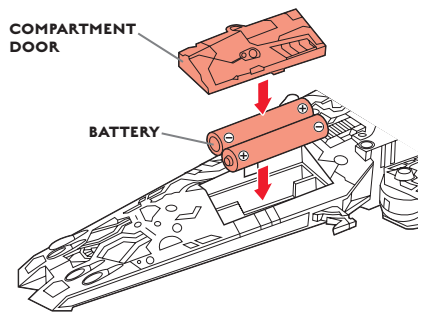

Using a Phillips/cross head screwdriver (not included), loosen screw in battery compartment door. Remove door. Insert 2 x 1.5V "AAA" or R03 size batteries. Alkaline batteries recommended. Replace door and tighten screw.

FCC Statement:

This device complies with part 15 of the FCC Rules. Operation is subject to the following two conditions: (1) This device may not cause harmful interference, and (2) this device must accept any interference received, including interference that may cause undesired operation. Changes or modifications to this unit not expressly approved by the party responsible for compliance could void the user's authority to operate the equipment. This equipment has been tested and found to comply with the limits for a Class B digital device, pursuant to part 15 of the FCC Rules. These limits are designed to provide reasonable protection against harmful interference in a residential installation. This equipment generates, uses and can radiate radio frequency energy, and, if not installed and used in accordance with the instructions, may cause harmful interference to radio communications. However, there is no guarantee that interference will not occur in a particular installation. If this equipment does cause harmful interference to radio or television reception, which can be determined by turning the equipment off and on, the user is encouraged to try to correct the interference by one or more of the following measures:

- Reorient or relocate the receiving antenna.
- Increase the separation between the equipment and receiver.
- Consult the dealer or an experienced radio/TV technician for help.

CAUTION:

- 1) As with all small batteries, the batteries used with this toy should be kept away from small children who still put things in their mouths. If they are swallowed, promptly see a doctor and, in the U.S., have the doctor phone (202) 625-3333 collect, or, in Canada, have the doctor call your provincial Poison Control Center.
- 2) Make sure the batteries are inserted correctly and follow the toy and battery manufacturers' instructions.
- 3) Do not mix old and new batteries, alkaline, standard (carbon-zinc) or rechargeable (nickel-cadmium) batteries.

IMPORTANT: BATTERY INFORMATION

Please retain this information for future reference. Batteries should be replaced by an adult.

CAUTION:

1. Always follow the instructions carefully. Use only batteries specified and be sure to insert them correctly by matching the + and - polarity markings.
2. Do not mix old batteries and new batteries, or standard (carbon-zinc) with alkaline batteries.
3. Remove exhausted or dead batteries from the product.
4. Remove batteries if product is not to be played with for a long time.
5. Do not short-circuit the supply terminals.
6. Should this product cause, or be affected by, local electrical interference, move it away from other electrical equipment. Reset (switching off and back on again or removing and re-inserting batteries) if necessary.
7. RECHARGEABLE BATTERIES: Do not mix these with any other types of battery. Always remove from the product before recharging. Recharge batteries under adult supervision. DO NOT RECHARGE OTHER TYPES OF BATTERIES.
8. As with all small items, these batteries should be kept away from children. If swallowed, seek medical attention immediately.



© 2004 Hasbro. All Rights Reserved. ® denotes Reg. U.S. Pat. & TM Office. Manufactured under license from Takara Co., Ltd.

Some poses may require hand support. Product and colors may vary.

GO TO
TRANSFORMERS.COM
ENTER THE CODE FROM THE CYBER PLANET
KEY FOR MORE TRANSFORMER INFO!



P/N 6458430000