

The SPECTACULAR
SPIDER-MAN
ANIMATED SERIES

OSCORP
Ooze
PLAYSETS

AGES 4+
91727/78813 Asst.

COMPOUND NET WT. 1.75 oz.
(49.6 grams)

WORK ZONE
SHOWDOWN

Includes:

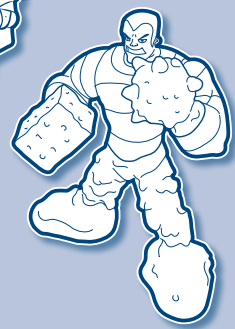
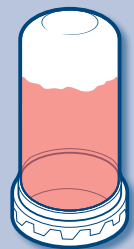
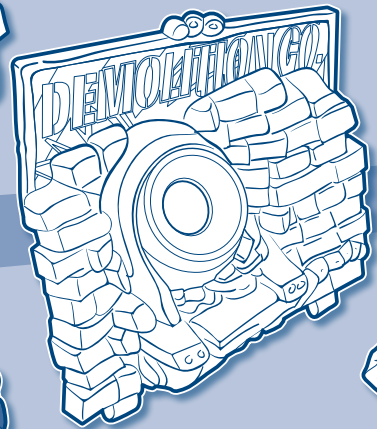
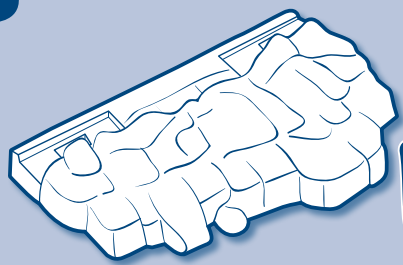

Assembly:

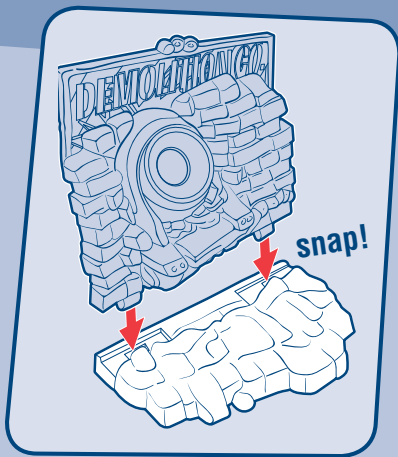

Not intended to be eaten. If spilt, remove excess compound, allow to dry, then scrape or vacuum deposits away. Always put compound back in container after play. Store in a cool place. If necessary, water may be added one drop at a time to restore softness.

Play:

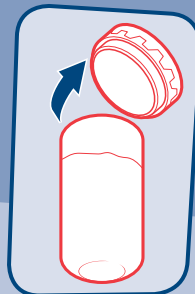

Place the compound in the back of the mixer, and use the rounded end of the canister to push it through.

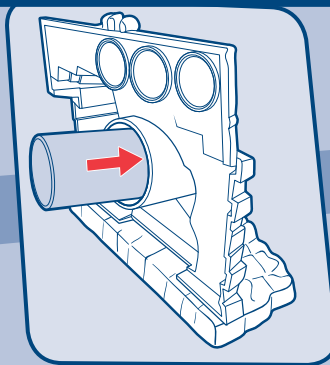

Not suitable for children under 3 years because of small parts — choking hazard.

<http://www.hasbro.com/spiderman>



Adult supervision is recommended.
NONTOXIC.

Spider-Man and all related characters: TM & © 2009 Marvel Characters B.V. The Spectacular Spider-Man, Animated Series: © 2009 Adelaide Productions, Inc. All rights reserved.

®* and/or TM* & © 2009 Hasbro. All Rights Reserved.
TM & © denote U.S. Trademarks.

P/N: 6943620000