

TRANSFORMERS ARMADA

AGES 5+
7052

▲ WARNING:
CHOKING HAZARD-Small parts.
Not for children under 3 years.



43 pcs.

ASSEMBLY REQUIRED.
KIT BUILDS 1 ROBOT/VEHICLE.

BTR
BUILT TO RULE!TM



DEMOLISHORTM 
with **BLACKOUT**TM **MINI-CON**TM

1.

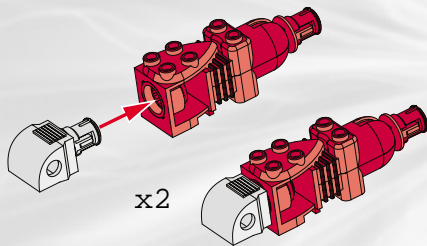
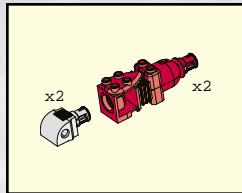

TRANS-SKELETON™

2.

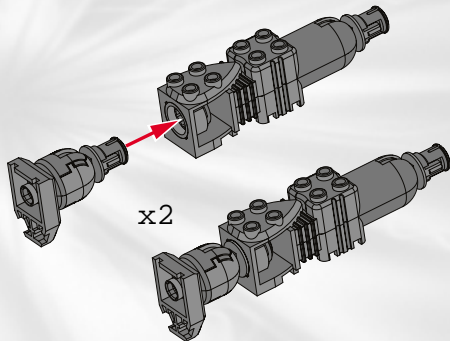
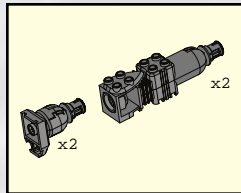

3.

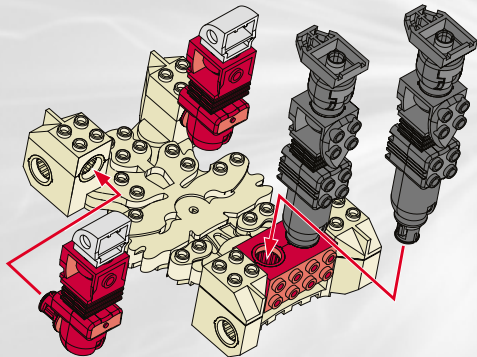
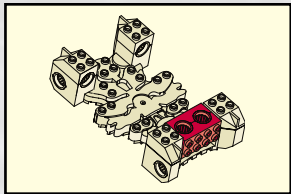

4.

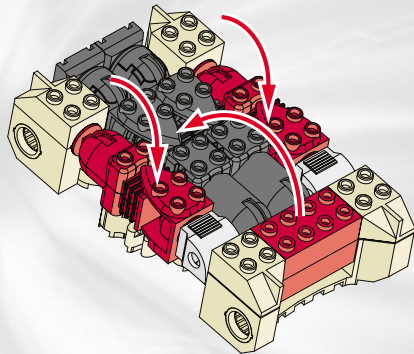

1.

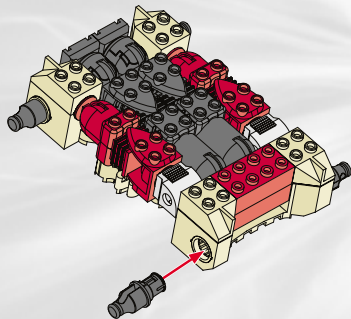
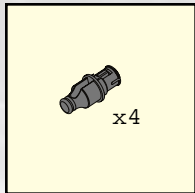
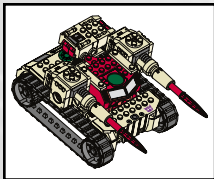

VEHICLE MODE

2.

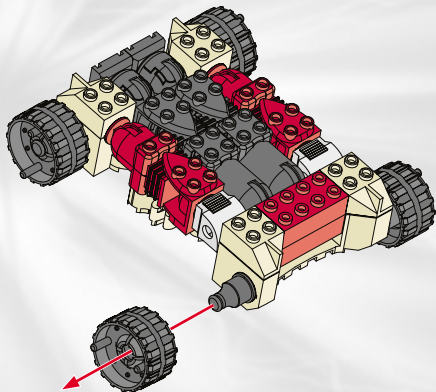
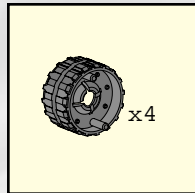

3.

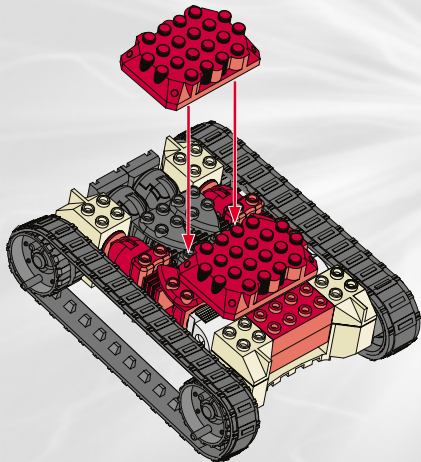
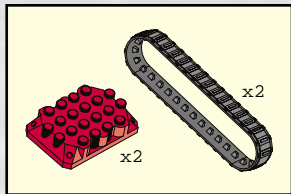

4.

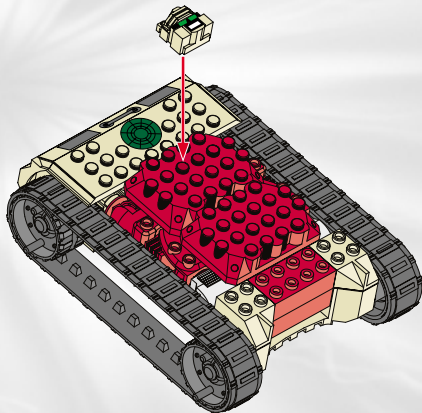
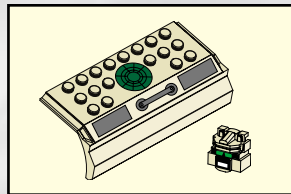

7.

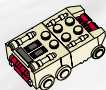
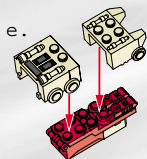
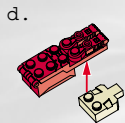
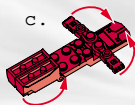
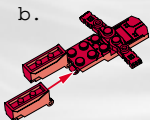
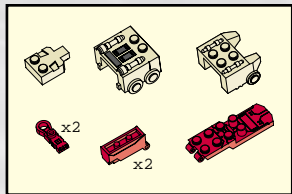

8.

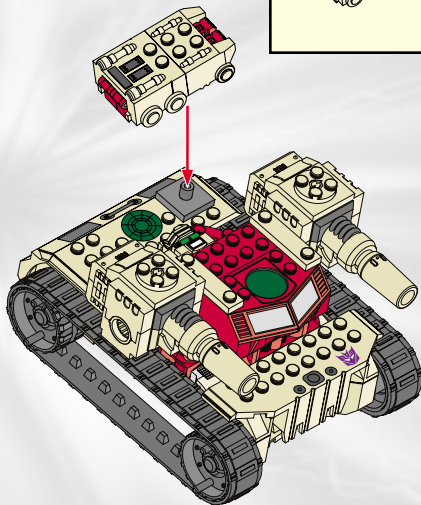
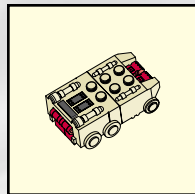

LAUNCHING MISSILE!

1.

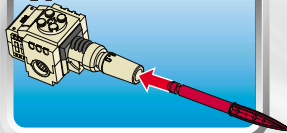

2.

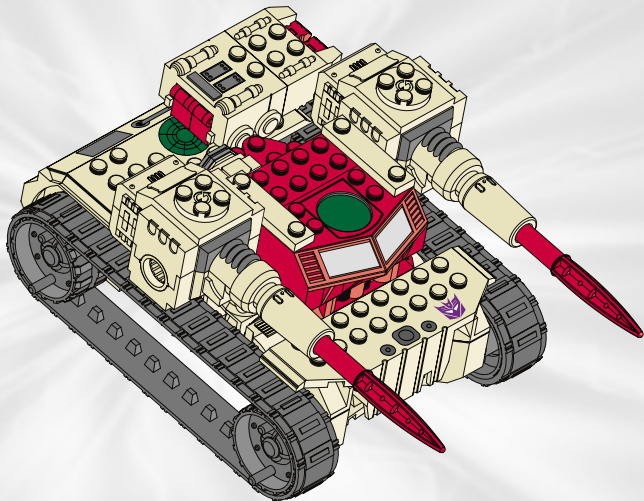
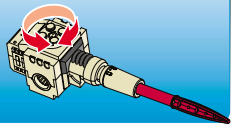

1.

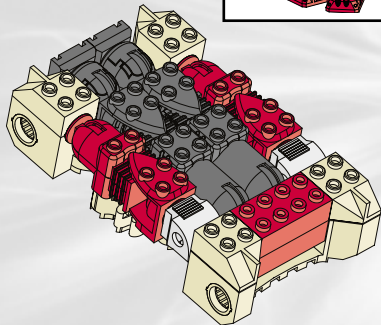
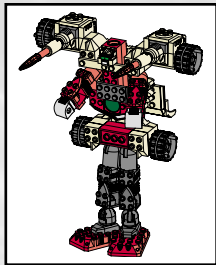

ROBOT MODE

2.

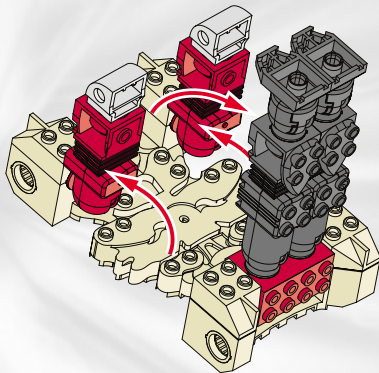

3.

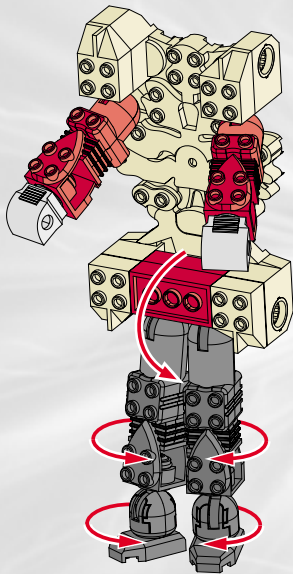

4.

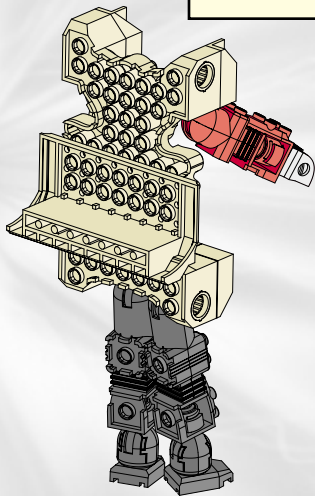
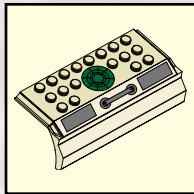

5.

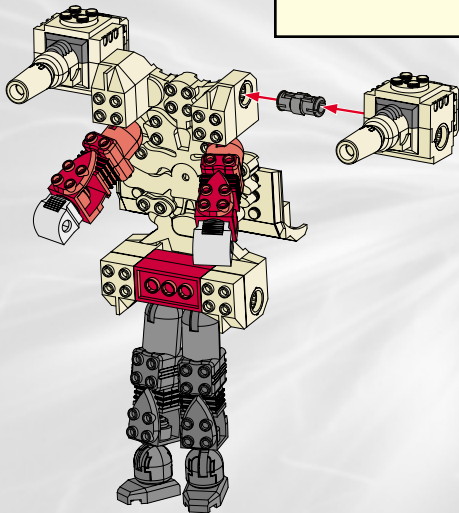
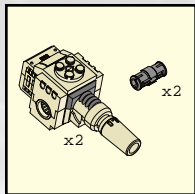

6.

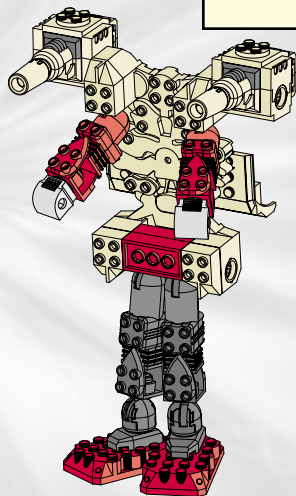
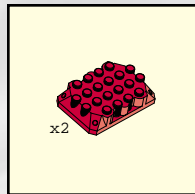

7.

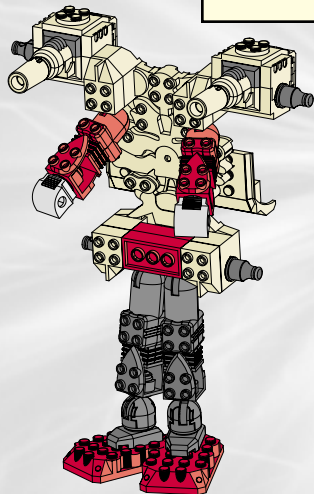
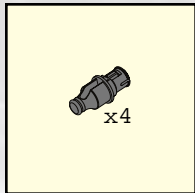

8.

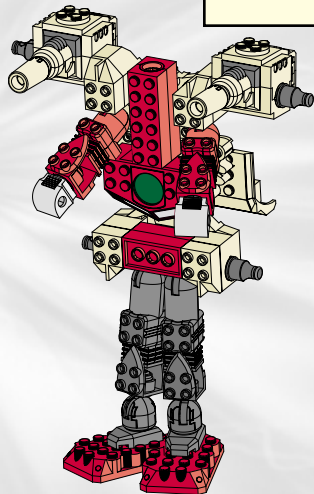
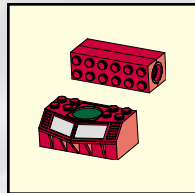

9.

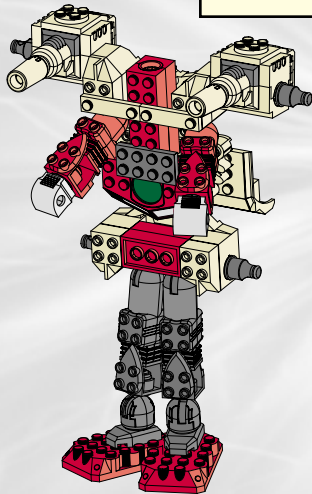
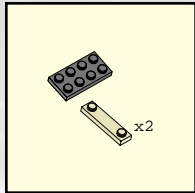

10.

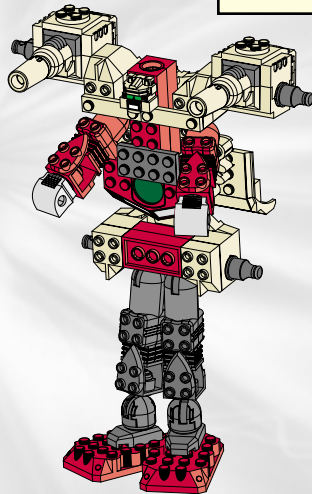
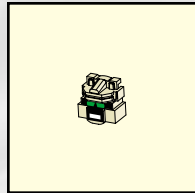

11.

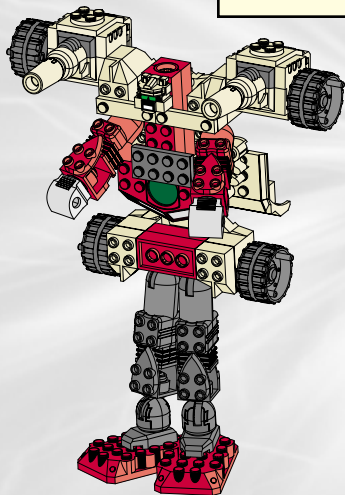
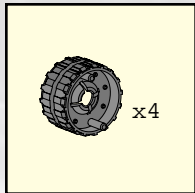

12.

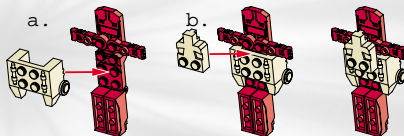
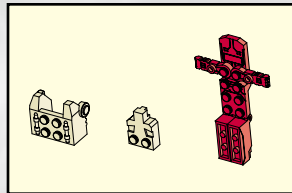

LAUNCHING MISSILE!

1.

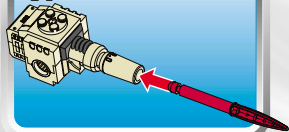

2.

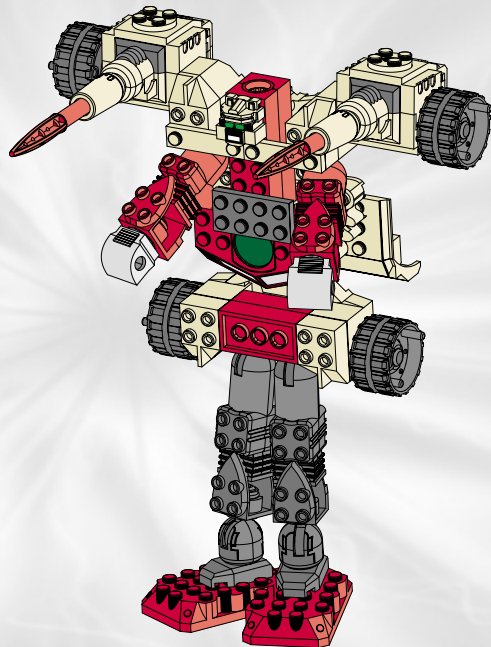
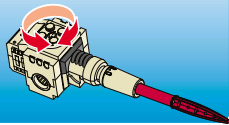

DEMOLISHER™



ROBOT MODE



VEHICLE MODE

P/N 6253910000



Product and colors may vary.
© 2003 Hasbro. All Rights Reserved.
*denotes Reg. U.S. Pat. & TM Office.
Manufactured under license from Takara Co., Ltd.
Hasbro Canada, Longueuil, QC, Canada J4G 1G2.

Questions?
Call: 1-800-327-8264

Please keep company details for future reference.
Distributed in the United Kingdom by Hasbro UK Ltd., Caswell Way, Newport, Gwent NP9 0YH.
Distributed in Australia by Hasbro Australia Ltd., 570 Blaxland Road, Eastwood, NSW 2122, Australia. Tel: (02) 9874-0999.
Distributed in New Zealand by Hasbro New Zealand Ltd., Albany Highways, Auckland, PO Box 100 940. North Shore Mail Centre, Auckland, New Zealand 1333. Tel: (09) 915-5200.



0-3

Not suitable for children under 36 months
due to small parts, choking hazard.

TRANSFORMERS.COM

