

TRANSFORMERS

DARK OF THE MOON™



WARNING:

CHOKING HAZARD—Small parts.
Not for children under 3 years.

AGES 5+

29702/28734 ASST.

AUTOBOT

INTERMEDIATE

SKYHAMMER™ LEVEL: 1 2 3

NOTE: Some parts are made to detach if excessive force is applied and are designed to be reattached if separation occurs. Adult supervision may be necessary for younger children.

CHANGING TO VEHICLE

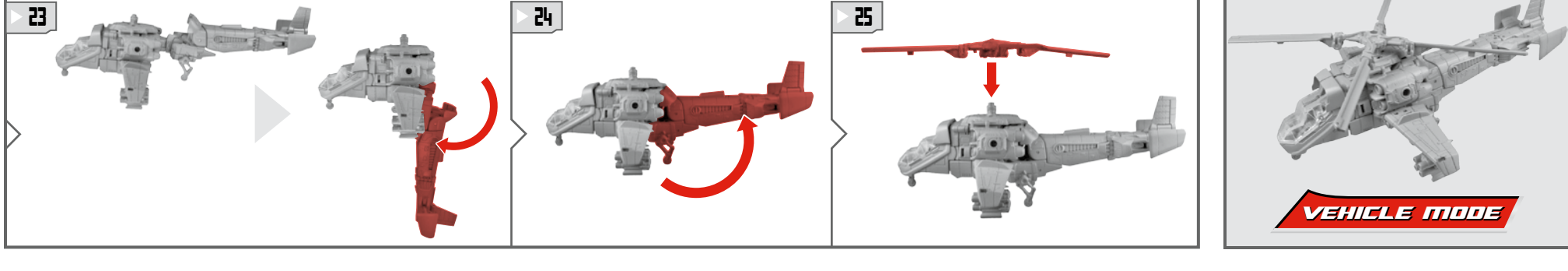
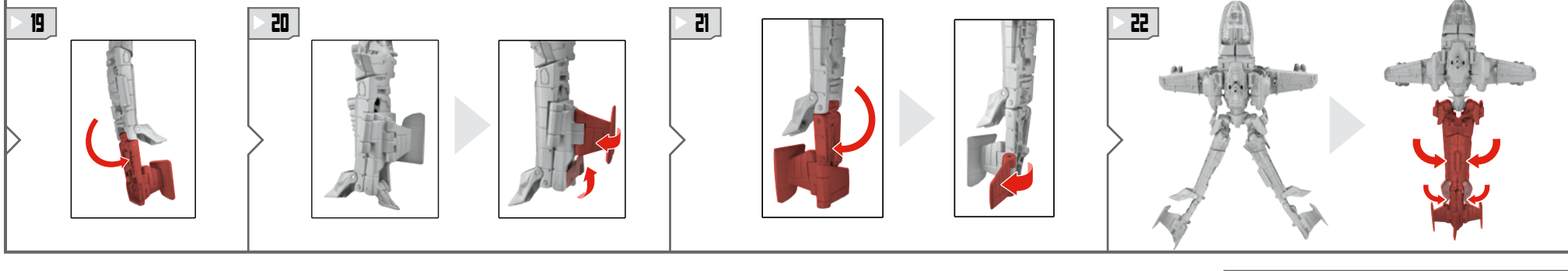
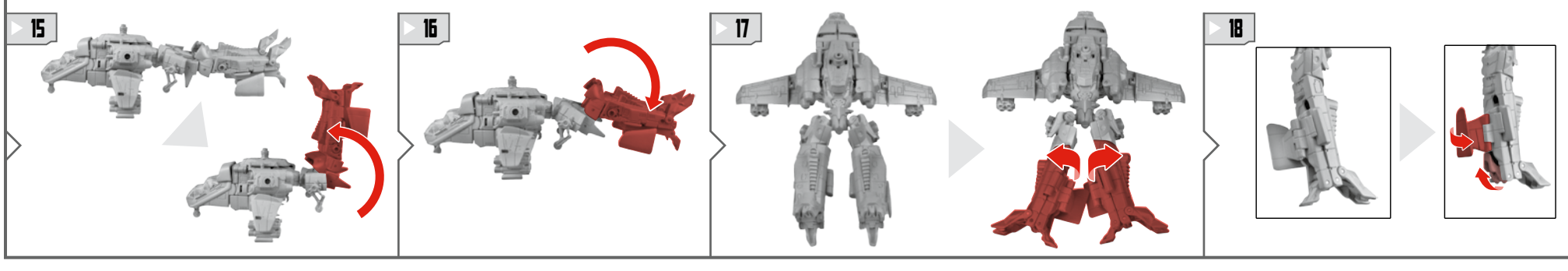
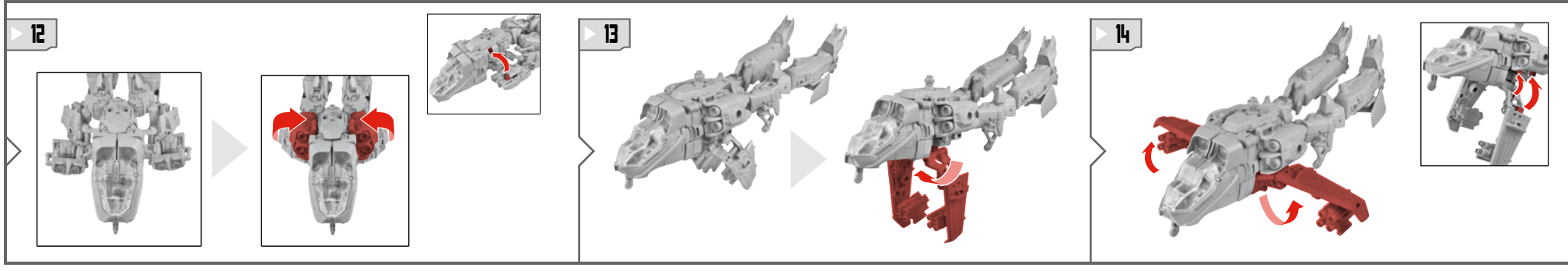
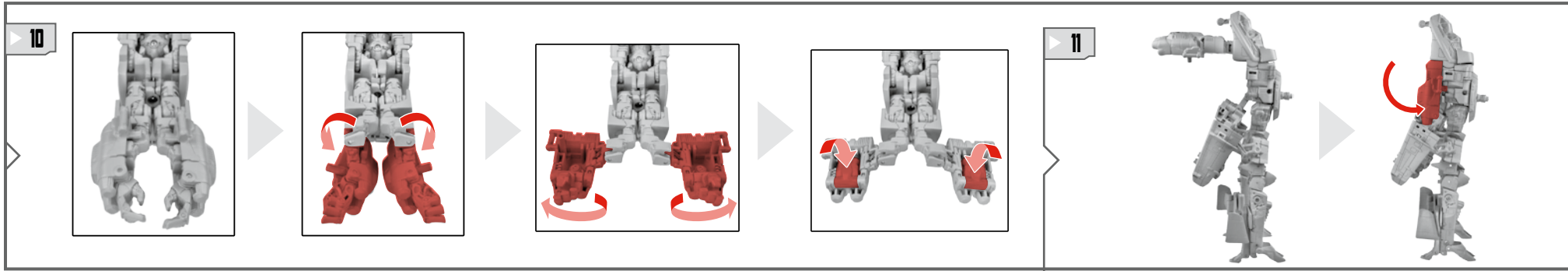
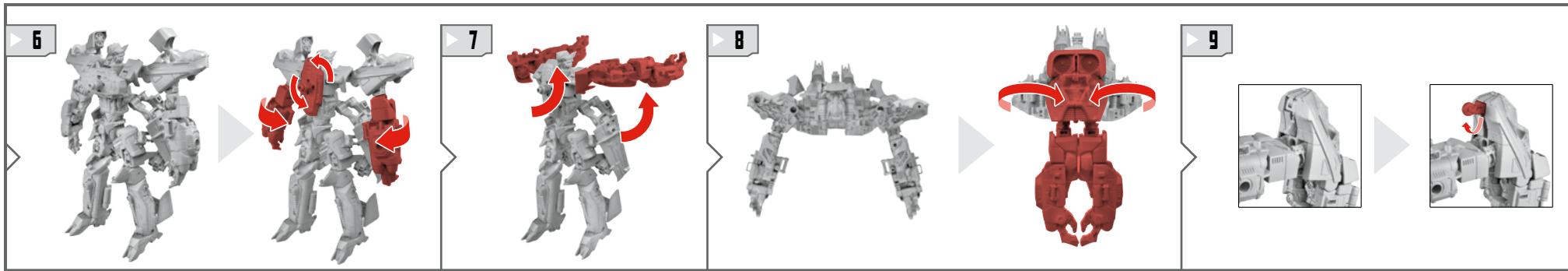
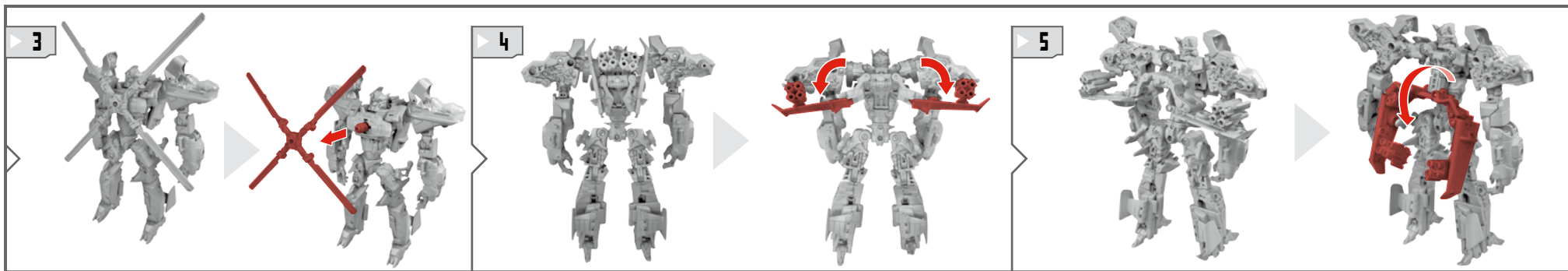
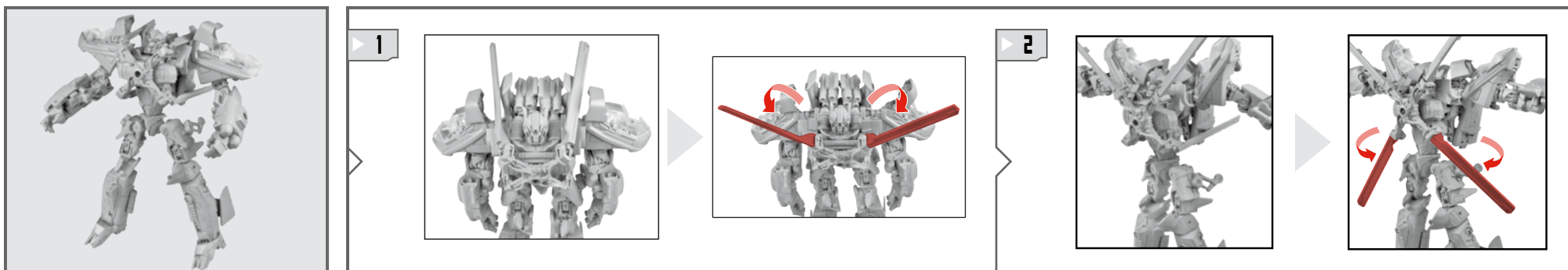

VEHICLE MODE

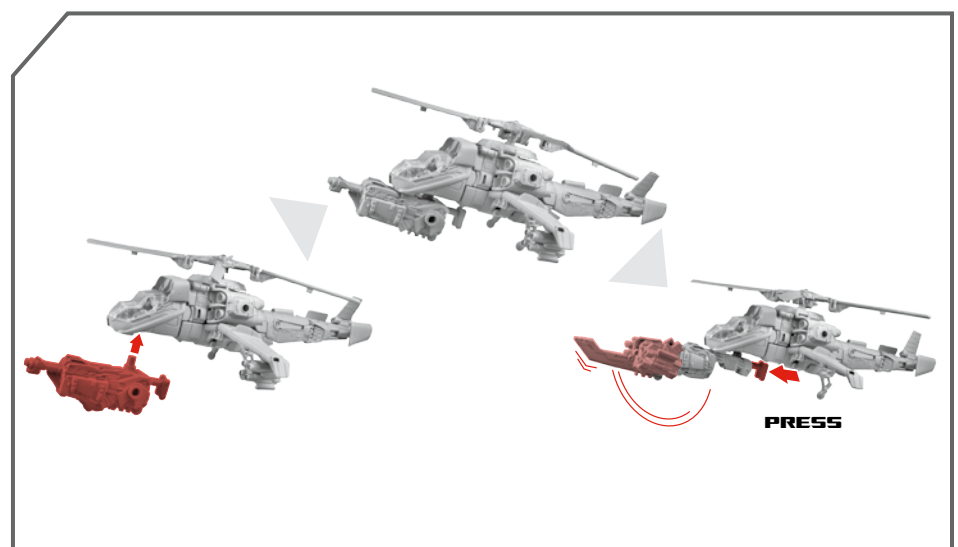
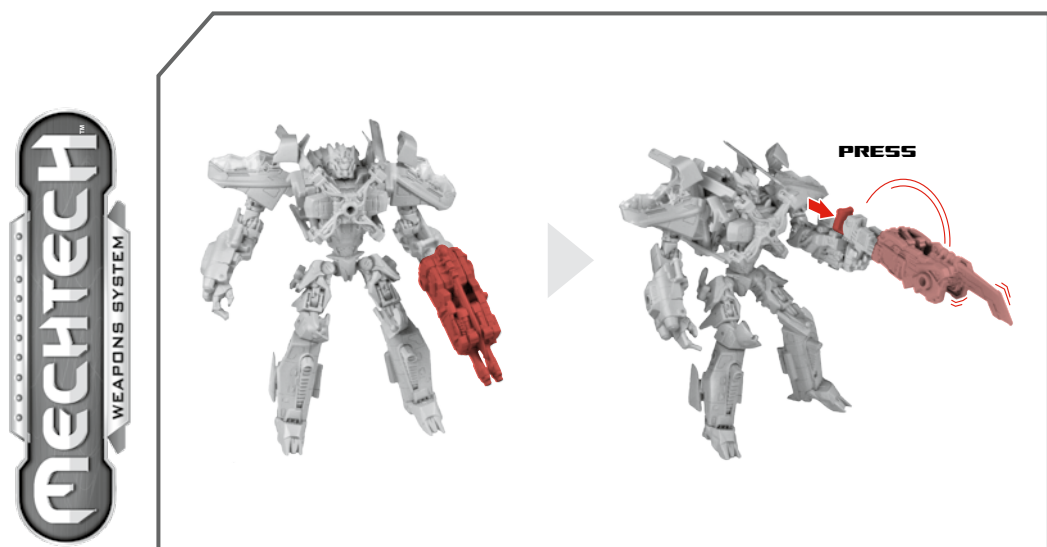
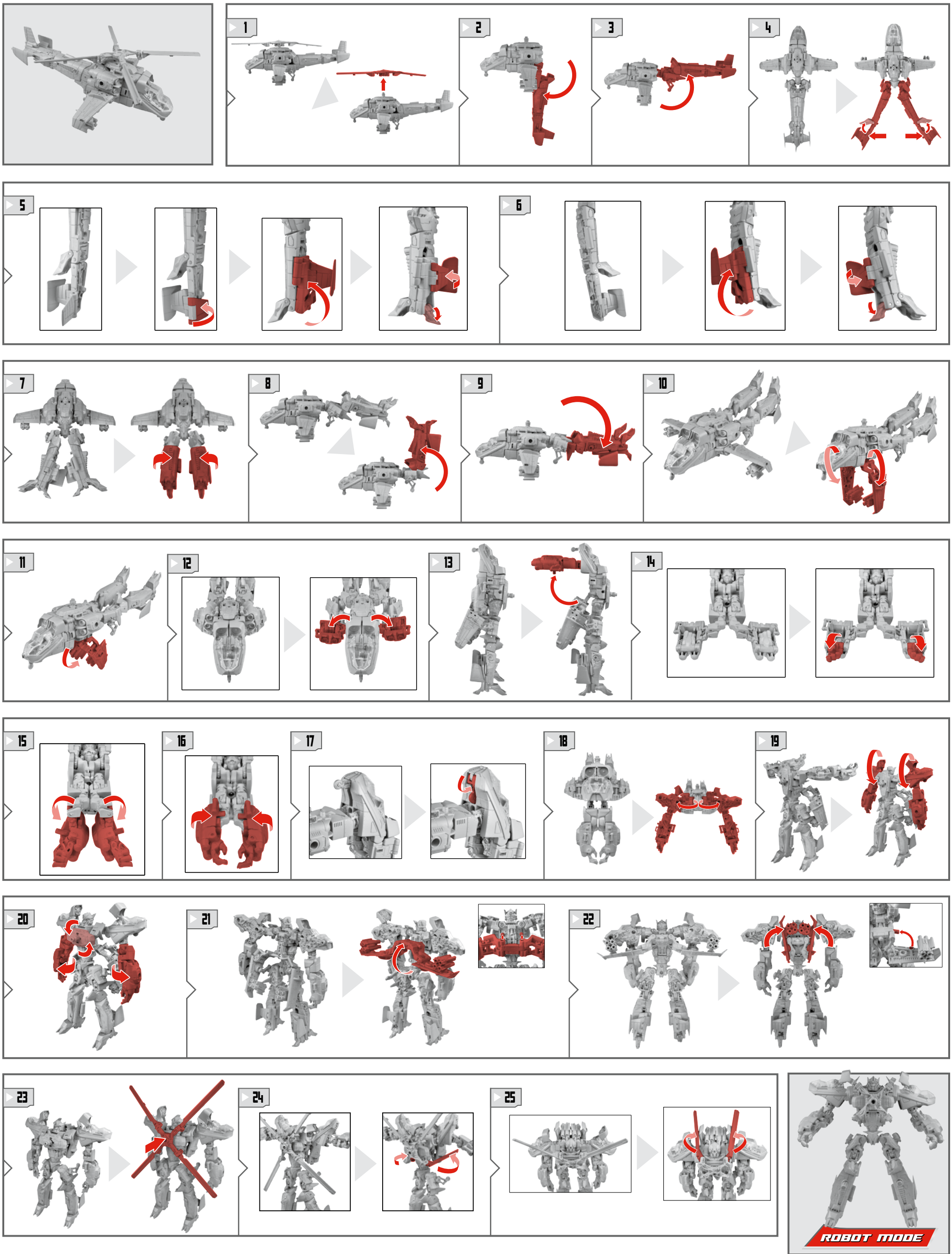

Retain instructions for future reference.



Product and colors may vary. Some poses may require hand support.
© 2010 Paramount Pictures Corporation.
Manufactured under license from TOMY Company, Ltd.
© 2010 Hasbro. All Rights Reserved. TM & © denote U.S. Trademarks.



P/N 7139220000

TRANSFORMERS.COM/INSTRUCTIONS